

Operation, Repair, Parts



SaniSpray HP™ 20 Cordless Airless Handheld

3A7649B

EN

For portable spraying of water-based disinfectants approved for spray application only. Not for applying architectural paints and coatings. Not approved for use in explosive atmospheres or hazardous (classified) locations. For professional use only.



Important Safety Instructions

Read all warnings and instructions in this manual, on the unit, and in the battery and charger manual before using the equipment. Be familiar with the controls and the proper usage of the equipment. Save these instructions.



Important Medical Information

Read the medical alert card provided with the sprayer. It contains injection injury treatment information for a doctor. Keep it with you when operating the equipment.

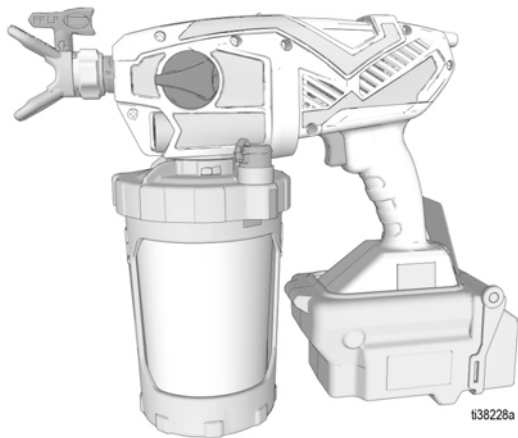

i38228a



WARNING

CHEMICAL HAZARD

To prevent serious injury:

- Follow all directions and requirements on disinfectant label. It is a violation of Federal law to use an EPA-approved disinfectant in a manner inconsistent with its labeling.
- Flush after each use. Never store disinfectant in equipment.
- Use only with appropriate personal protective equipment.



Questions?
844-241-9499
www.graco.com/techsupport



POWERED BY

DEWALT®

*Use only genuine Graco replacement parts.
The use of non-Graco replacement parts may void warranty.*

PROVEN QUALITY. LEADING TECHNOLOGY.

Contents

Models	3
Important User Information	4
General Power Tool Safety Information	5
Warnings	7
Know Your Sprayer	9
Start Up	10
Battery Installation and Removal	10
Pressure Relief Procedure	10
Flushing a New Sprayer	11
Starting a New Job	12
How to Spray	15
Choose Your Spray Tip	15
Spray Tip Orientation	16
Starting Your Spray and Adjusting Pressure	16
Clear Tip Clogs	17
Refilling FlexLiner	18
Cleanup and Storage	19
Cleaning Sprayer	19
Storage	22
Static Grounding Instructions	23
Maintenance	24
Cleaning Outlet Valves	24
Recycling and Disposal	25
End of Product Life	25
Troubleshooting	26
Parts	28
Technical Specifications	30
California Proposition 65	30
Graco Limited Warranty	31
Graco Information	32



Intertek

110474

Certified to CAN/CSA C22.2 No. 68
Conforms to UL 1450

Models

Model	Sprayer Name	Charger Voltage	Tip Family	Tip Size
25R791	SaniSpray HP 20 Cordless Airless Handheld	120V	LPxxx	0.013-0.019 in (0.33-0.48 mm)

Maximum Working Pressure: 1000 psi (6.9 MPa, 68.9 bar)

The SaniSpray HP 20 Cordless Airless Handheld is compatible with the following DEWALT batteries:

- DCB200
- DCB201
- DCB203
- DCB204
- DCB205
- DCB207
- DCB230

Important User Information

Important User Information



Before using your disinfectant sprayer, read this manual for complete instructions on proper use and safety warnings.



You must also read and follow the information on the disinfectant container label and ask for a Safety Data Sheet (SDS) from your supplier. The container label and SDS will explain the contents of the material, instructions for use and the specific precautions related to the contents of the material. Those precautions include personal protective equipment (PPE).



The sprayer is designed to spray disinfectants that are water-based and clean up with water.



KNOW YOUR DISINFECTANT'S ACTIVE INGREDIENTS

For the purpose of safely using this sprayer, you need to know what kind of **active ingredients** are in the disinfectant. Look on the container label for the list of active ingredients. There are two categories:



ALCOHOL: This type of disinfectant contains flammable active ingredients such as ethanol (ethyl alcohol) or isopropanol (IPA). The container label should indicate that this material is **COMBUSTIBLE** or **FLAMMABLE**. Your sprayer is compatible with this type of material. Use flammable materials in a well-ventilated area with a flow of fresh air. See the safety warnings in this manual.



NON-ALCOHOL: This type of disinfectant contains active ingredients such as aldehydes, phenols, quaternary ammonium compounds, sodium hypochlorite (bleach), peroxyacetic acid, hydrogen peroxide, and hypochlorous acid. Your sprayer is compatible with this type of material.

General Power Tool Safety Information

WARNING

Read all safety warnings and all instructions.

Failure to follow the warnings and instructions may result in electric shock, fire and/or serious injury.

Save all warnings and instructions for future reference.

The term “power tool” in the warnings refers to your mains-operated power tool.

Work Area Safety

- **Keep work area clean and well lit.** Cluttered or dark areas invite accidents.
- **Do not operate power tools in explosive atmospheres, such as in the presence of flammable liquids, gases or dust.** Power tools create sparks which may ignite the dust or fumes.
- **Keep children and bystanders away while operating a power tool.** Distractions can cause you to lose control.

Electrical Safety

- **Power tool plugs must match the outlet. Never modify the plug in any way. Do not use any adapter plugs with earthed (grounded) power tools.** Unmodified plugs and matching outlets will reduce risk of electric shock.
- **Avoid body contact with earthed or grounded surfaces, such as pipes, radiators, ranges and refrigerators.** There is an increased risk of electric shock if your body is earthed or grounded.
- **Do not expose power tools to rain or wet conditions.** Water entering a power tool will increase the risk of electric shock.
- **Do not abuse the cord. Never use the cord for carrying, pulling or unplugging the power tool. Keep cord away from heat, oil, sharp edges or moving parts.** Damaged or entangled cords increase the risk of electric shock.
- **When operating a power tool outdoors, use an extension cord suitable for outdoor use.** Use of a cord suitable for outdoor use reduces the risk of electric shock.
- **If operating a power tool in a damp location is unavoidable, use a residual current device (RCD) protected supply.** Use of an RCD reduces the risk of electric shock.

Personal Safety

- **Stay alert, watch what you are doing and use common sense when operating a power tool. Do not use a power tool while you are tired or under the influence of drugs, alcohol or medication.** A moment of inattention while operating power tools may result in serious personal injury.
- **Use personal protective equipment. Always wear eye protection.** Protective equipment such as dust mask, non-skid safety shoes, hard hat, or hearing protection used for appropriate conditions will reduce personal injuries.
- **Prevent unintentional starting. Ensure the switch is in the off-position before connecting to power source and/or battery pack, picking up or carrying the tool.** Carrying power tools with your finger on the switch or energizing power tools that have the switch on invites accidents.
- **Remove any adjusting key or wrench before turning the power tool on.** A wrench or a key left attached to a rotating part of the power tool may result in personal injury.
- **Do not overreach. Keep proper footing and balance at all times.** This enables better control of the power tool in unexpected situations.
- **Dress properly. Do not wear loose clothing or jewelry. Keep your hair, clothing and gloves away from moving parts.** Loose clothes, jewelry or long hair can be caught in moving parts.
- **If devices are provided for the connection of dust extraction and collection facilities, ensure these are connected and properly used.** Use of dust collection can reduce dust-related hazards.

General Power Tool Safety Information

WARNING

Power Tool Use and Care

- **Do not force the power tool. Use the correct power tool for your application.** The correct power tool will do the job better and safer at the rate for which it was designed.
- **Do not use the power tool if the switch does not turn it on and off.** Any power tool that cannot be controlled with the switch is dangerous and must be repaired.
- **Disconnect the plug from the power source before making any adjustments, changing accessories, or storing power tools.** Such preventive safety measures reduce the risk of starting the power tool accidentally.
- **Store idle power tools out of the reach of children and do not allow persons unfamiliar with the power tool or these instructions to operate the power tool.** Power tools are dangerous in the hands of untrained users.
- **Maintain power tools. Check for misalignment or binding of moving parts, breakage of parts and any other condition that may affect the power tool's operation. If damaged, have the power tool repaired before use.** Many accidents are caused by poorly maintained power tools.
- **Use the power tool, accessories etc. in accordance with these instructions, taking into account the working conditions and the work to be performed.** Use of the power tool for operations different from those intended could result in a hazardous situation.

Service

- **Have your power tool serviced by a qualified repair person using only identical replacement parts.** This will ensure that the safety of the power tool is maintained.

Warnings

The following warnings are for the setup, use, grounding, maintenance, and repair of this equipment. The exclamation point symbol alerts you to a general warning and the hazard symbols refer to procedure-specific risks. When these symbols appear in the body of this manual or on warning labels, refer back to these Warnings. Product-specific hazard symbols and warnings not covered in this section may appear throughout the body of this manual where applicable.

WARNING



CHEMICAL HAZARD

Toxic disinfectant or fumes can cause serious injury or death if splashed in the eyes or on skin, inhaled, or swallowed.



- Keep away from children.
- Use only to spray surfaces. Do not spray humans or animals.
- Use only with appropriate personal protective equipment. See **PERSONAL PROTECTIVE EQUIPMENT**, page 8.
- Follow all directions and requirements on disinfectant label. It is a violation of Federal law to use an EPA-approved disinfectant in a manner inconsistent with its labeling.
- Flush with water after each use. Never store disinfectant in equipment.
- Read Safety Data Sheets (SDSs) to know the specific hazards of the disinfectants you are using.
- Store and dispose of disinfectants according to instructions on disinfectant container labels.



SKIN INJECTION HAZARD

High-pressure spray is able to inject toxins into the body and cause serious bodily injury that can result in amputation. In the event that injection occurs, **get immediate surgical treatment**.



- Use only to spray surfaces. Do not spray humans or animals.
- Do not point spray tip at anyone or place any part of your body in front of tip. For example, do not try to stop leaks with any part of the body.
- Always use the spray tip guard. Do not spray without spray tip guard in place. Use only Graco spray tips.
- Use caution when cleaning and changing spray tips. In the case where the spray tip clogs while spraying, follow the **Pressure Relief Procedure**, page 10, for turning off the unit and relieving the pressure before removing the spray tip to clean.
- Equipment maintains pressure after power is shut off. Do not leave the equipment energized or under pressure while unattended. Remove battery and follow the **Pressure Relief Procedure**, page 10, when the equipment is unattended or not in use, and before servicing, cleaning, or removing parts.
- Check parts for signs of damage. Replace any damaged parts.
- This system is capable of producing 1000 psi . Use Graco replacement parts or accessories that are rated a minimum of 1000 psi .
- Do not carry the sprayer with a finger on the trigger.
- Verify that all connections are secure before operating the unit.
- Know how to stop the unit and bleed pressure quickly. Be thoroughly familiar with the controls.

Warnings

WARNING



FIRE AND EXPLOSION HAZARD

Flammable fumes, such as disinfectants, in work area can ignite or explode. To help prevent fire and explosion:



- Do not spray flammable disinfectants near an open flame or sources of ignition such as cigarettes, motors, and electrical equipment.



- Disinfectants flowing through the sprayer are able to result in static electricity. Static electricity creates a risk of fire or explosion in the presence of disinfectant fumes. Reverse spray tip when flushing. The sprayer and all objects in spray area shall be properly grounded to protect against static discharge, sparks, or shocks.



- If there is static sparking or you feel a shock, stop operation immediately. Do not use sprayer until you identify and correct the problem.
- Verify that all containers and collection systems are grounded to prevent static discharge.
- Keep spray area well-ventilated. Keep a good supply of fresh air moving through the area.
- Do not smoke in the spray area or spray where sparks or flame is present.
- Do not operate light switches, engines, or similar spark producing products in the spray area.
- Keep area clean and free of disinfectant containers, rags, and other flammable materials.
- Know the contents of the disinfectants being sprayed. Read all Safety Data Sheet (SDS) and container labels provided with the disinfectants. Follow the disinfectant manufacturer's safety instructions.
- Keep a working fire extinguisher in the work area.



EQUIPMENT MISUSE HAZARD

Misuse can cause death or serious injury.



- Do not operate or spray near children. Keep children away from equipment at all times.
- Do not overreach or stand on an unstable support. Keep effective footing and balance at all times.
- Stay alert and watch what you are doing.
- Do not operate the unit when fatigued or under the influence of drugs or alcohol.
- Always replace cracked, broken or missing parts immediately with genuine Graco parts. See **Parts**, page 28.
- Do not alter or modify equipment. Alterations or modifications may void agency approvals and create safety hazards.
- Use only in dry locations. Do not expose to water or rain.
- Use in well-lit areas.
- Make sure all equipment is rated and approved for the environment in which you are using it.
- Do not operate or clean sprayer with the battery shield open.



BATTERY AND CHARGER COMPATIBILITY HAZARD

- Only use DEWALT brand 18V Max or 20V Max batteries and battery chargers with this tool.
- **READ ALL INSTRUCTIONS** included with this tool regarding the safety and usage of DEWALT batteries and battery chargers.
- Do not wash or spray down battery.
- Do not clean the battery with anything other than a cloth moistened with water.



PERSONAL PROTECTIVE EQUIPMENT

Wear appropriate protective equipment when in the work area to help prevent serious injury, including eye injury, burns, hearing loss, and inhalation of disinfectant chemical mists and vapors. Protective equipment includes but is not limited to:

- Protective eye-wear, and hearing protection.
- Appropriate respirators, protective clothing, and gloves.
- All protective equipment specified by the disinfectant manufacturer.

Know Your Sprayer

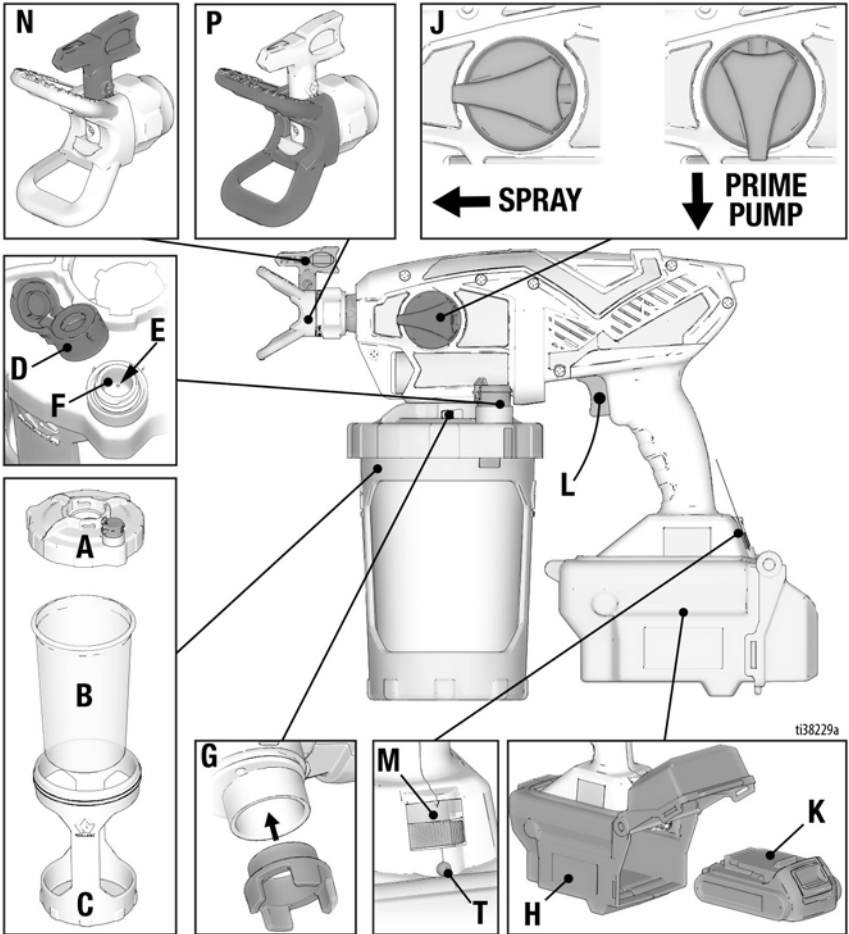

A	Cup Lid
B	FlexLiner
C	Cup Support
D	VacuValve Cap
E	VacuValve Air Hole
F	VacuValve Reservoir
G	Pump Filter
H	Battery Shield

J	Prime Knob
K	Battery
L	Trigger
M	Speed Control, ProControl II
N	Spray Tip
P	Spray Tip Guard
T	Diagnostic Light

Start Up

Battery Installation and Removal

Always start with a fully charged Battery. Do not splash or immerse Battery or charger in water. See Battery and charger information shipped with the sprayer.



Replace and charge Battery only in a well-ventilated area and away from flammable or combustible materials, including disinfectants. Do not operate sprayer with the Battery Shield open.

NOTICE

The sprayer is equipped with a non-removable Battery Shield to protect the Battery during spraying of disinfectants. Attempting to remove the Battery Shield will result in damage to the sprayer and Battery.

Remove and install Battery into the sprayer as follows:

1. Open the back of the Battery Shield by unlatching the door and lifting upwards.
2. Remove the used Battery, if in place.

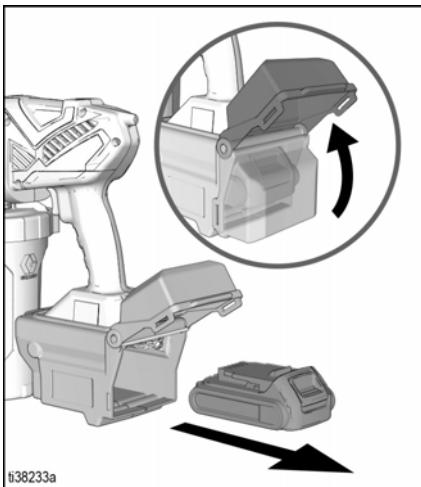

3. Install fully charged Battery into the sprayer.
4. Fully close and latch the door of the Battery Shield.

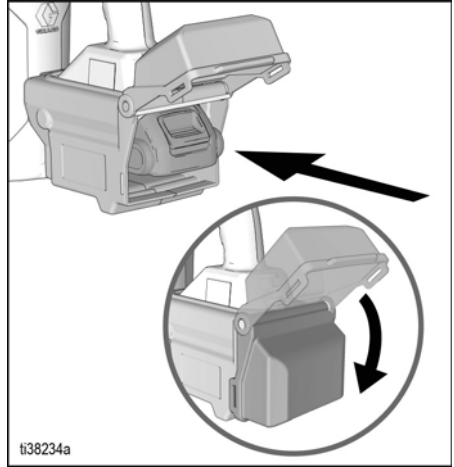

Pressure Relief Procedure



Follow the Pressure Relief Procedure whenever you see this symbol.



This sprayer builds up an internal pressure of 1000 psi (6.9 MPa, 68.9 bar) during use. To help prevent serious injury from pressurized fluid, such as skin injection and splashing fluid, follow the **Pressure Relief Procedure** whenever you stop spraying and before cleaning, checking, servicing, or transporting equipment to prevent serious injury.

1. Remove Battery from the sprayer.

- Turn the Prime Knob downward to PRIME position to relieve pressure.

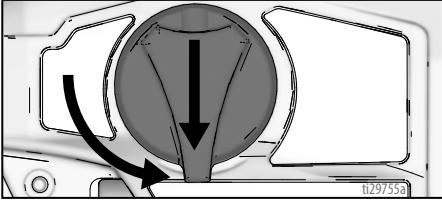

Flushing a New Sprayer

This sprayer arrives from the factory with a small amount of test fluid in the system. **It is important that you flush this fluid from the sprayer before using for the first time.**

See **Static Grounding Instructions**, page 23, for additional information when using disinfectants with alcohol active ingredients, or other flammable disinfectants.

- Insert a FlexLiner into the Cup Support.

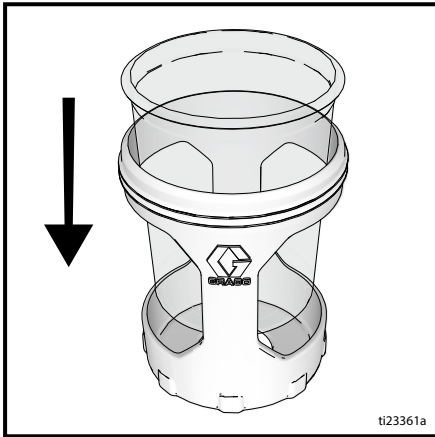

- Fill FlexLiner with warm water.



- Firmly tighten the Cup Lid onto the Cup Support to achieve an airtight seal.

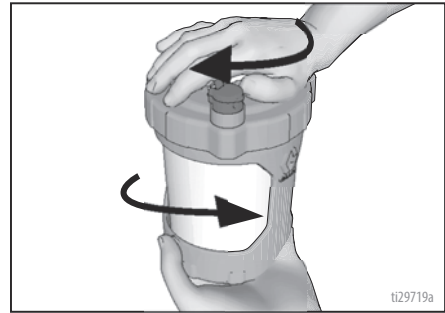

- Install the cup assembly onto the sprayer as follows:
 - Align VacuValve Cap on the Cup Lid with the Prime Knob.

Start Up

- b. Push cup assembly onto the sprayer. Twist to lock.

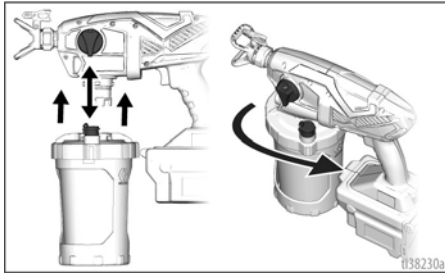

5. Install Battery into the sprayer.
6. Make certain the Prime Knob is downward in PRIME position. Set Speed Control to 10.
7. Turn the sprayer upside down and point the sprayer into a waste bucket. Pull the Trigger for five seconds. Water will not spray but recirculate through the pump and back to the cup.

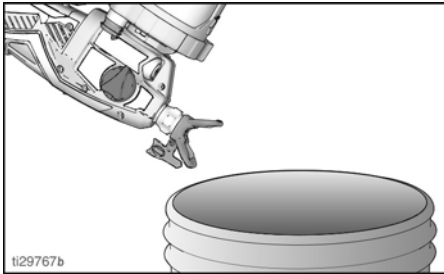

8. Turn Prime Knob forward to SPRAY position. Rotate Spray Tip 180 degrees to UNCLOG position.

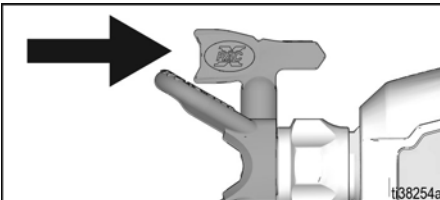
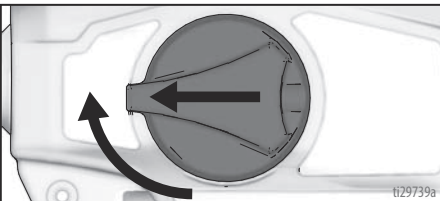

9. While holding the sprayer upside down, point the sprayer into a waste bucket. Pull the Trigger for 30 seconds.

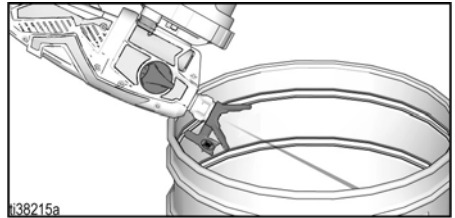

NOTICE

Do not run sprayer without fluid. Running sprayer dry will cause damage to the pump.

10. Pour any remaining water out of FlexLiner into waste bucket.
11. Sprayer is now flushed and ready for use. See **Starting a New Job**, page 12.

Starting a New Job



When spraying flammable or combustible disinfectants:

- Move entire sprayer to a well-ventilated area and away from flammable or combustible materials, including disinfectants, when refilling.
- Keep disinfectant containers covered between cup refills.

Refer to disinfectant label for manufacturer's recommendations on proper dilution of disinfectant. Properly dilute disinfectant in a separate container. Foam in disinfectant may cause operation issues. Wait until foam has subsided to fill FlexLiner.

If you are using the sprayer for the very first time, see **Flushing a New Sprayer**, page 11.

1. Perform **Pressure Relief Procedure**, page 10.

2. Insert one FlexLiner into the Cup Support and fill with properly diluted disinfectant.

NOTE: Verify there is no damage, such as a crease, on the top surface of the FlexLiner. If damaged, DO NOT USE.

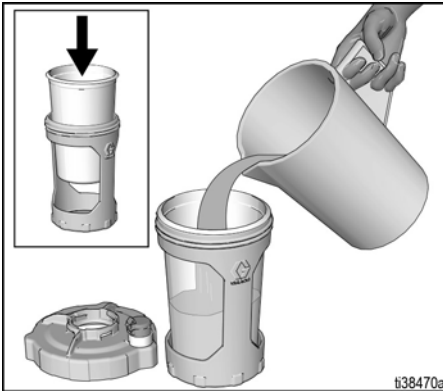

3. Firmly tighten Cup Lid onto the Cup Support to ensure an airtight seal.

NOTE: Petroleum jelly on the inside of the top of the Cup Lid will help ensure an airtight seal.

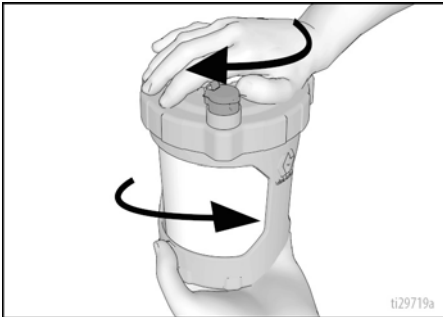

4. Verify Pump Filter is installed and clean.

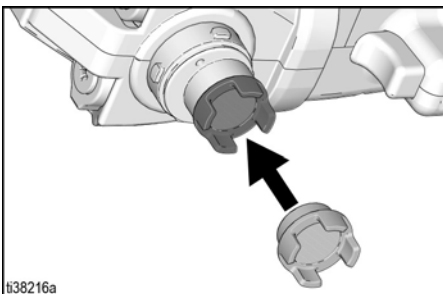

5. Install the cup assembly onto the sprayer as follows:
 - a. Align VacuValve Cap on the Cup Lid with the Prime Knob.
 - b. Push cup assembly onto the sprayer. Twist to lock.

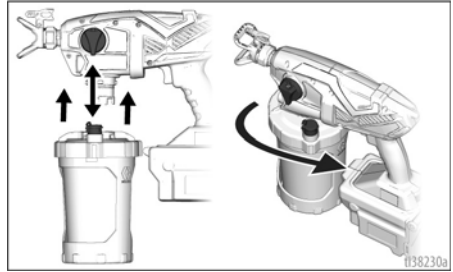

6. Prime the pump with disinfectant as follows:

- a. Verify Prime Knob is pointed down to PRIME position.

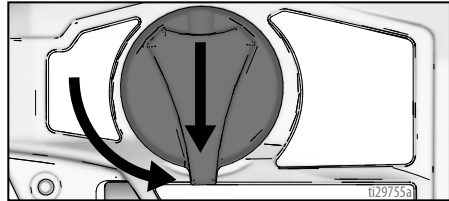

- b. Install a fully charged battery into the sprayer.

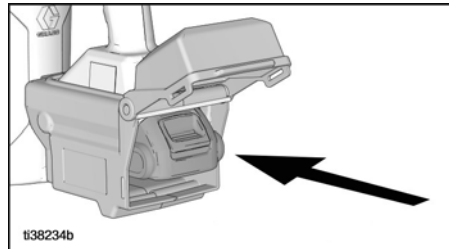

Start Up

- c. Turn sprayer upside down. Pull the Trigger for 5 seconds.

NOTE: Disinfectant will not spray out, but will recirculate through the pump and back to the cup.

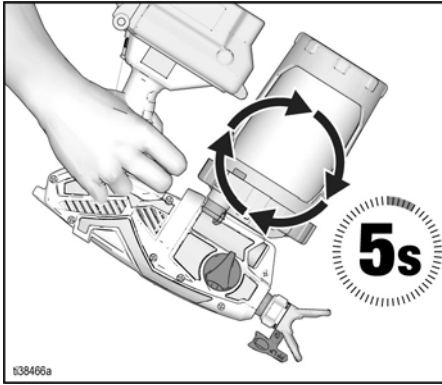

- d. Turn sprayer upright and open the VacuValve Cap.

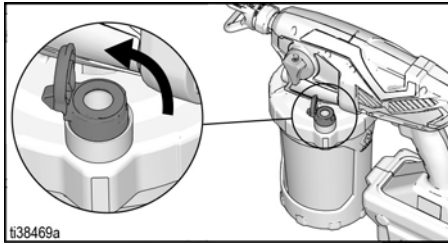

- e. Tilt sprayer so the VacuValve is the highest point.
- f. Gently squeeze the FlexLiner until disinfectant enters the VacuValve reservoir and all air is evacuated from the cup.

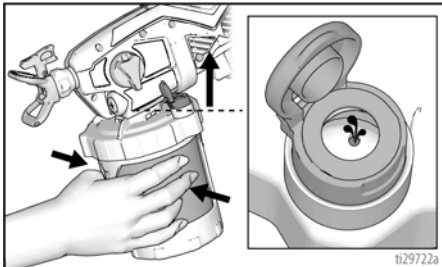

- g. While continuing to squeeze the FlexLiner, close the VacuValve cap.

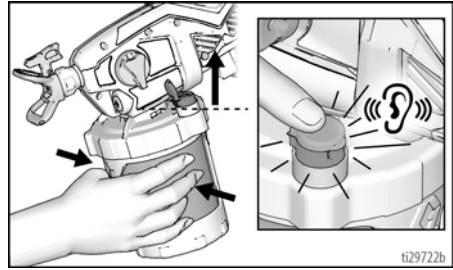

NOTE: If FlexLiner is not squeezed while VacuValve Cap is open, air will quickly pull into the FlexLiner. If any air bubbles are visible in the cup, repeat steps E-G.

7. Turn Prime Knob forward to **SPRAY** position. Verify Spray Tip is forward in the **SPRAY** position.

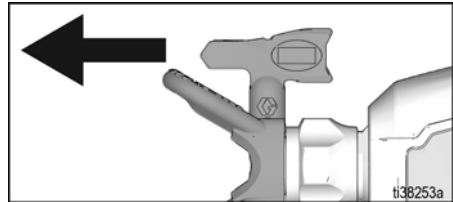
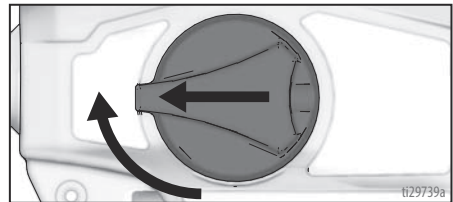

8. Pull the Trigger to verify disinfectant sprays from the sprayer. If sprayer does not spray within 5 seconds, **STOP** and repeat Start Up.

NOTICE

Do not run sprayer without fluid. Running sprayer dry will cause damage to the pump.

How to Spray



Use only disinfectants approved for spray application.

Fumes from disinfectants with alcohol active ingredients, or from other flammable disinfectants, can explode or ignite. Sprayer generates sparks. To prevent fumes from exploding or igniting:

- Keep spray area well-ventilated.
- Keep a good supply of fresh air moving through the area.
- Follow **Static Grounding Instructions**, page 23.

Choose Your Spray Tip



To avoid serious injury from skin injection, do not put your hand in front of the Spray Tip when installing or removing the Spray Tip and Spray Tip Guard.

Your sprayer comes with 3 Spray Tip sizes:

Fine	LP313
Medium	LP515
Coarse	LP619

Your sprayer comes from the factory with the Medium size Spray Tip installed. Select the appropriate Spray Tip size to provide the acceptable spray of disinfectant. Refer to disinfectant label for manufacturer's recommendations.

To prevent Spray Tip leaks, make certain Spray Tip and Spray Tip Guard are installed properly.

1. Perform **Pressure Relief Procedure**, page 10.

2. Use Spray Tip (A) to align TipSeal™ (B) (gasket and seal) into the Spray Tip Guard (C).

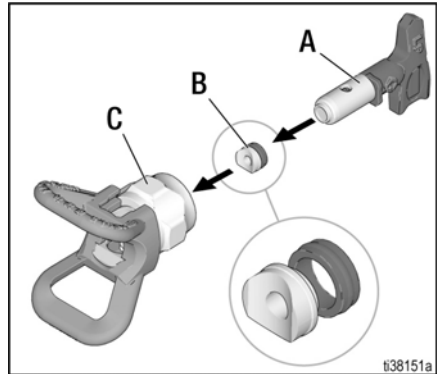

3. Insert Spray Tip into Spray Tip Guard. Verify Spray Tip is forward in the SPRAY position.

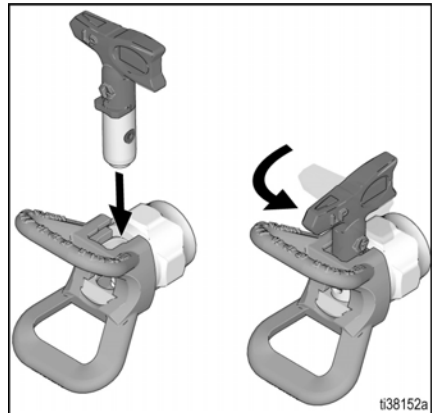

4. Screw Spray Tip Guard assembly onto sprayer and hand tighten.

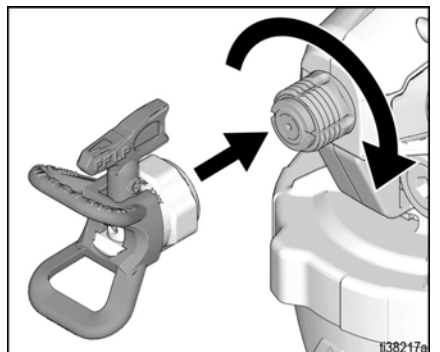

How to Spray

NOTE: Spray Tip will wear with use and need periodic replacement.

Spray Tip Orientation



To avoid serious injury from skin injection, do not put your hand in front of the Spray Tip Guard when rotating it.

Adjust the Spray Tip Guard for desired vertical or horizontal spraying direction.

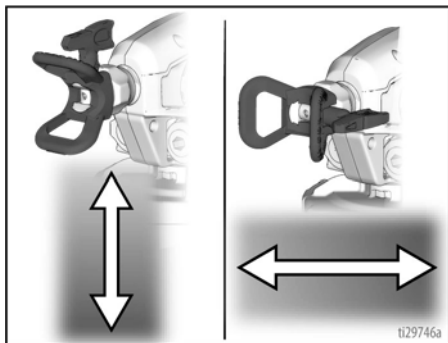

Starting Your Spray and Adjusting Pressure

Always refer to the disinfectant manufacturer's recommendations for an acceptable spray of disinfectant.

1. Point sprayer toward the surface to be sprayed.
2. Set the Speed Control to the lowest setting.
3. Pull and hold Trigger.

4. Slowly increase pressure using the Speed Control. Set the minimum setting necessary to produce an acceptable spray of disinfectant. This will help reduce overspray.

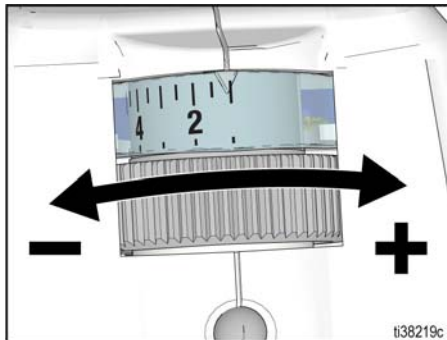

5. Adjust the sprayer's distance from the surface and your hand speed to achieve the desired surface coverage.

NOTE: For best results, and to evacuate all disinfectant from the FlexLiner when the disinfectant is nearly gone, gently squeeze the bottom of the FlexLiner to push the last of the disinfectant up to the Cup Lid.

If sprayer does not spray, try the steps below:

- Make certain there is only one FlexLiner in Cup Support. It is possible for two liners to nest tightly together and appear as only one.
- Make certain there is no damage, such as a crease, on the top surface of the FlexLiner. If damaged, DO NOT USE.

- Make certain the Cup Lid is properly threaded to the Cup Support. If threads are visible below the Cup Lid when tight, then the cover is cross-threaded. Fully remove the Cup Lid and reinstall to the Cup Support so no threads are visible when tight.

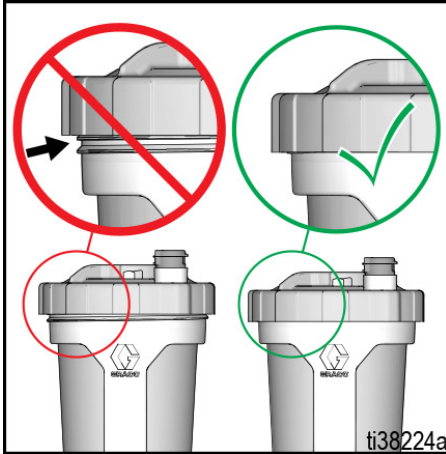

- Repeat steps 6 – 8 on page 13 to ensure all the air is evacuated from the FlexLiner.
- Make certain the Spray Tip is not clogged. See **Clear Tip Clogs**, page 17.
- If sprayer sprays disinfectant while holding sprayer upside down, there is air in the cup. See **Starting a New Job**, page 13, steps 6 – 8.
- Replace VacuValve Cap. Two new VacuValve caps came with your sprayer.
- If sprayer still does not spray, see **Troubleshooting**, page 26.

Clear Tip Clogs



To avoid injury, never point sprayer at your hand or into a rag!

In the event debris clogs the Spray Tip, the sprayer is designed with a reversible Spray Tip that quickly and easily clears the particles without disassembling the sprayer.

1. To unclog Spray Tip, turn Prime Knob downward to PRIME position.

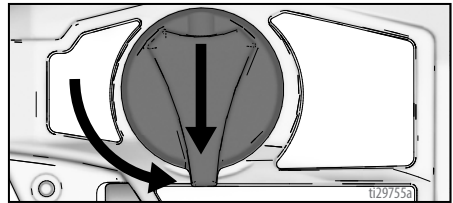

2. Reverse Spray Tip to UNCLOG position.

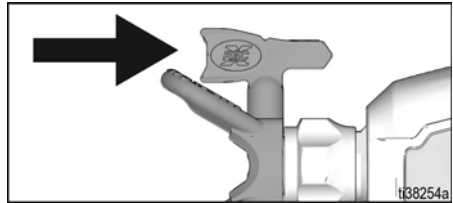

3. Set Speed Control to 10.



How to Spray

4. Point sprayer into waste bucket, turn Prime Knob forward to SPRAY position. Pull Trigger for 5 seconds to clear clog.

NOTE: If Spray Tip is still clogged, you may have to repeat steps 1 – 4, or replace with new Spray Tip assembly. See **Choose Your Spray Tip**, page 15.

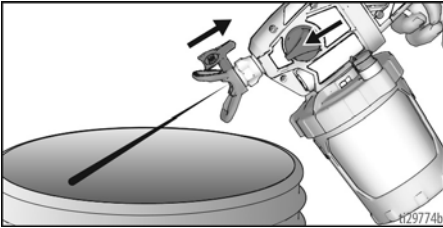

5. Turn Prime Knob downward to PRIME position. Rotate Spray Tip back to SPRAY position. Turn Prime Knob forward to SPRAY position, and resume spraying.

Refilling FlexLiner

When spraying flammable or combustible disinfectants:				
<ul style="list-style-type: none">• Move entire sprayer to a well-ventilated area and away from flammable or combustible materials, including disinfectants, when refilling.• Keep disinfectant containers covered between cup refills.				

If sprayer runs out of disinfectant, simply refill the FlexLiner as follows:

1. Perform **Pressure Relief Procedure**, page 10.
2. Remove cup assembly from sprayer. Set sprayer on a rag to capture any disinfectant that may drip.
3. Separate Cup Lid from Cup Support.
4. Follow steps 2 – 8 in **Starting a New Job**, page 12.

Cleanup and Storage

Cleaning the sprayer with warm water is required after each use to remove any disinfectants and residues from the sprayer. Sufficient cleaning, followed by draining all water from the system will help ensure a trouble free start up the next time the sprayer is used.

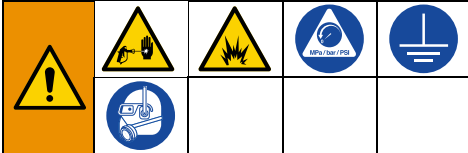

Use only water for cleaning.

Clean in a well-ventilated area. Keep a good supply of fresh air moving through the area.

To avoid serious injury or damage to equipment, do not expose the sprayer electronics to water. Keep sprayer **at least 10 in. (25 cm)** above the rim of the container when cleaning.

Follow **Static Grounding Instructions**, page 23, when using disinfectants with alcohol active ingredients, or other flammable disinfectants.

NOTICE

Disinfectant left in sprayer will damage the sprayer. To avoid damage, always completely flush with warm water after every use. See **Cleaning Sprayer**, page 19. Do not store sprayer with disinfectant in it.

Cleaning Sprayer

1. Perform **Pressure Relief Procedure**, page 10.

2. Remove cup assembly from sprayer. Set sprayer on a rag to capture any disinfectant that may drip.

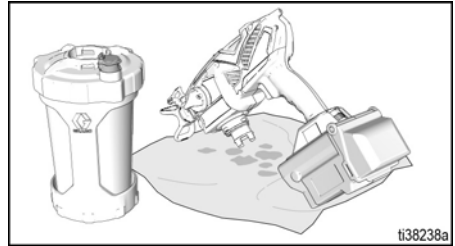

3. Separate Cup Lid from Cup Support.
4. Pour excess disinfectant into waste bucket. Hold the FlexLiner in place when pouring. Wipe excess disinfectant from Cup Lid.



5. Dispose of used FlexLiner and insert a new FlexLiner into the Cup Support.
6. Fill FlexLiner with warm water.

Cleanup and Storage

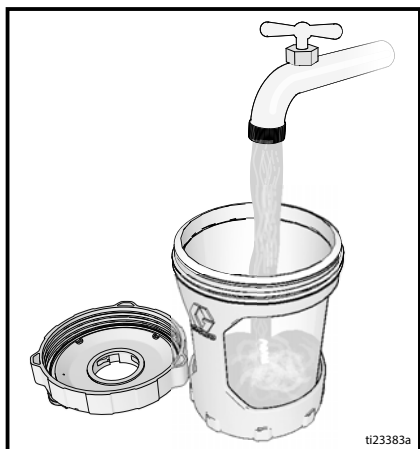

7. Firmly tighten the Cup Lid onto the Cup Support to achieve an airtight seal.

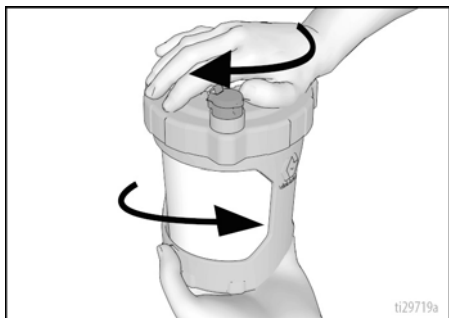

8. Install the cup onto the sprayer.

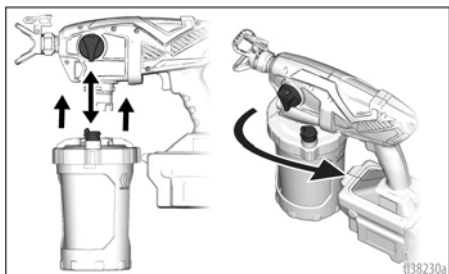

9. Make certain the Prime Knob is downward in PRIME position. Set Speed Control to 10.

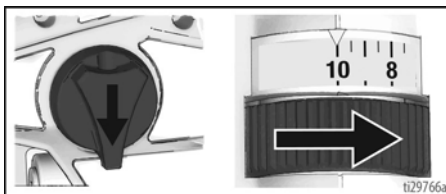

10. Turn the sprayer upside down and point the sprayer into a waste bucket. Pull the Trigger for 10 seconds to clean the pump. Water will not spray but recirculate through the pump and back to the cup.

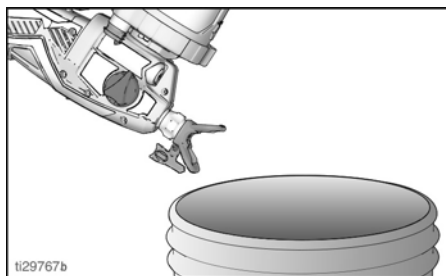

11. Turn Prime Knob forward to SPRAY position.
12. While holding the sprayer upside down, point the sprayer into a waste bucket.
- a. With the Spray Tip in the SPRAY position, pull the Trigger for 10 seconds. Release the Trigger.

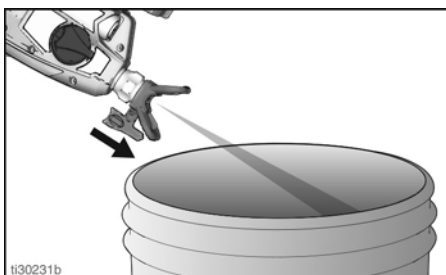

Cleanup and Storage

- b. Reverse the Spray Tip to UNCLOG position, pull the Trigger for 30 seconds until sprayer is clean. Release the Trigger.

NOTICE

Do not run sprayer without fluid. Running sprayer dry will cause damage to the pump.

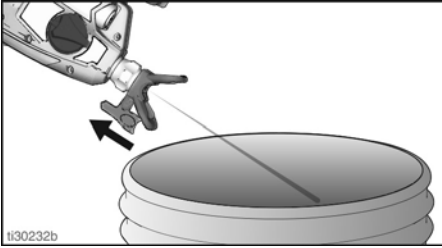

13. Turn Prime Knob downward to PRIME position.
14. Disconnect power (remove battery).
15. Remove cup assembly from sprayer. Separate Cup Lid from Cup Support and pour unused water into waste bucket.
16. Dispose of the fluid in the waste bucket according to the instructions on the disinfectant container label and applicable regulations.
17. Remove Spray Tip, Spray Tip Guard, and Pump Filter from sprayer. Clean with warm water. A soft brush can be used if needed.

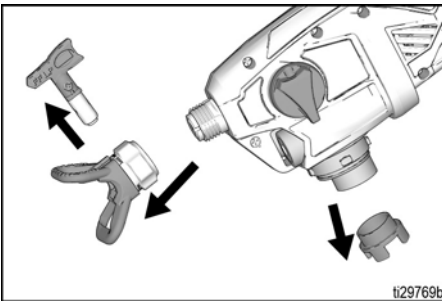

18. Use a soft cloth to clean the Cup Support and Cup Lid.

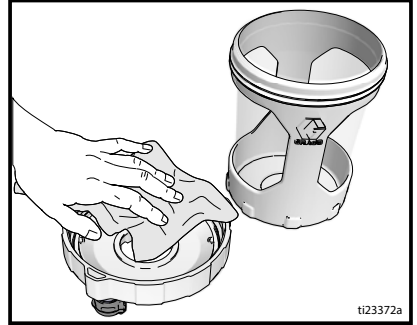

19. Wipe disinfectant off the outside of the sprayer using a soft cloth moistened with water.

NOTICE

Do NOT submerge the sprayer. Do NOT splash, immerse, or spray down the battery or charger. Do NOT clean the battery with anything other than a soft cloth moistened with water. Doing these will cause damage to the sprayer.



This sprayer is equipped with a static wick that reduces the build-up of static charge to reduce the risk of fire and explosion. **KEEP THE WICK SURFACE CLEAN.**

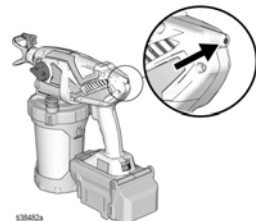

Cleanup and Storage

Storage

- Do not allow water to freeze in sprayer.
- Do not store sprayer under pressure. Confirm the Prime Knob is downward in PRIME position.

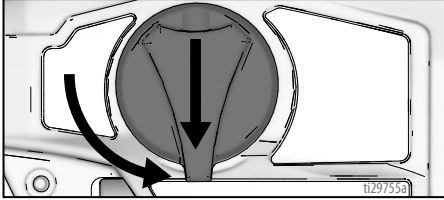

- Store sprayer in an upright position only.
- Store sprayer indoors in a cool, dry place.
- Store Spray Tip, Spray Tip Guard, and Pump Filter with sprayer so they are available for the next job.

Static Grounding Instructions



The waste bucket must be grounded to reduce the risk of static sparking. A static spark can cause fumes to ignite or explode. A good ground provides an escape wire for the electric current.

For disinfectants with alcohol active ingredients or other flammable disinfectants:

- Always use a metal bucket for disinfectants with alcohol active ingredients, or other flammable disinfectants, when sprayer is flushed or cleaned.

- Follow local code. Use only conductive metal buckets, placed on a grounded surface such as concrete.
- Do not place bucket on a non-conductive surface such as paper or cardboard which interrupts ground continuity.

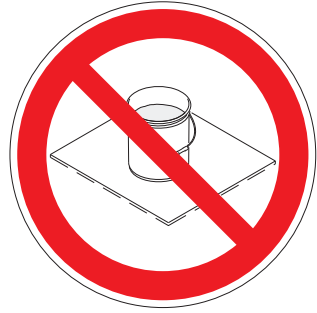

Maintenance

Routine maintenance is important to ensure proper operation of your sprayer.



Move entire sprayer to a well-ventilated area and away from flammable or combustible materials, including disinfectants.

Activity	Interval
Inspect pump filter.	Daily or each time you spray
Inspect enclosure vents for blockage.	Daily or each time you spray
Inspect pump inlet holes located under pump filter for blockage.	Each time the sprayer is cleaned

Cleaning Outlet Valves

Dirt and debris in the outlet valve assemblies may affect sprayer performance and require cleaning.

- To clean the three outlet valves, remove two pump plugs and front valve. Remove pump plugs with an 8mm or (5/16") Allen wrench.

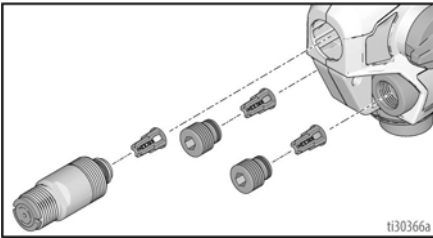

- Clean outlet valve assemblies with warm water.
- Check ball should move freely against the spring in the retainer.

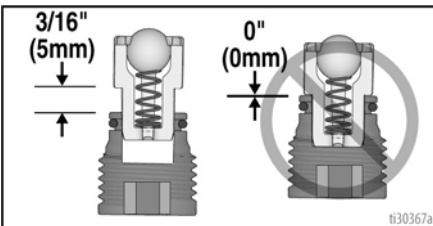

- If outlet valve assembly was removed from the valve plug, assemble as shown. Leave a space between the end of the plug or front valve and shoulder on the outlet valve assembly.

NOTICE

Do not push outlet valves all the way into the valve plugs or front valve. If outlet valves are pushed all the way into the valve plugs or front valve the sprayer will spray with reduced performance.

- Make certain o-rings are on the valve plugs and front valve.
- Install two pump plugs and front valve. Use an 8mm or (5/16") Allen wrench to install pump plugs. Torque front valve to 55-65 in-lb (6.2 - 7.3 N•m) and pump plugs to 23-25 in-lb (2.6 - 2.8 N•m).

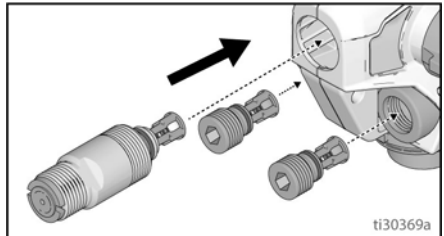

Recycling and Disposal

End of Product Life

At the end of the product's useful life, dismantle and recycle it in a responsible manner.

- Perform the **Pressure Relief Procedure**, page 10.
- Drain and dispose of fluids according to applicable regulations. Refer to the material manufacturer's Safety Data Sheet.

- Remove motors, batteries, circuit boards, LCDs (liquid crystal displays), and other electronic components. Recycle according to applicable regulations.
- Do not dispose of electronic components with household or commercial waste.



- Deliver remaining product to a recycling facility.

Troubleshooting



Disconnect power and relieve pressure before disassembling or repairing. See **Pressure Relief Procedure**, page 10.



Sprayer Diagnostics

Problem	Cause	Solution
Sprayer makes no sound when Trigger is pulled	Diagnostic Light blinks two times when Trigger is pulled. Indicates incorrect voltage.	Replace Battery with a charged Battery.
		Replace Enclosure/ SmartControl assembly.
	Diagnostic Light blinks three times when Trigger is pulled. Indicates Battery temperature is too hot or cold.	Allow Battery to cool down or warm up to room temperature.
		Replace pump assembly and enclosure/SmartControl assembly.
	Diagnostic Light does not blink when Trigger is pulled. Indicates Battery is not installed or is damaged.	Install or replace Battery.
Sprayer makes sound but no material is sprayed when Trigger is pulled	Sprayer is not primed.	Prime the pump. See Pressure Relief Procedure , page 10.
		Make certain there is only one FlexLiner in the Cup Support.
		Make certain the Cup Lid is properly threaded to the Cup Support. If threads are visible below the Cup Lid when tight, fully remove and reinstall to the Cup Support so no threads are visible when tight.
		Make certain the Cup Lid is tightened to Cup Support so the arrow on Cup Lid is within range of indicator on Cup Support.
		Make certain the cup assembly is properly locked on the sprayer.
		Make certain all the air is out of the FlexLiner and the VacuValve is properly closed.
		Clean VacuValve Reservoir and air hole.
		Clean sprayer. See Cleanup and Storage , page 19.

Problem	Cause	Solution
Sprayer makes sound but no material is sprayed when Trigger is pulled (continued)	Prime Knob is in PRIME PUMP position.	Turn Prime Knob forward to SPRAY position.
	Spray Tip is not in SPRAY position.	Turn Spray Tip to SPRAY position.
	Pump Filter plugged.	Clean Pump Filter.
	Speed Control is set too low.	Increase speed until unit sprays.
	No or low material in material cup.	Refill FlexLiner with material and prime the pump. See Refilling FlexLiner , page 18.
	Pump has reached the end of its life.	Replace pump assembly.
Sprayer sprays with poor coverage	Diagnostic Light blinks four times when the Trigger is pulled. Indicates a locked rotor condition.	Replace pump assembly and enclosure/SmartControl assembly.
	Spray Tip is not in correct position	Rotate Spray Tip to SPRAY position.
	Spray Tip is worn or damaged	Replace Spray Tip. See Choose Your Spray Tip , page 15.
Sprayer runs intermittently or very slow	Pump has reached the end of its life.	Replace pump assembly.
	Disinfectant has gotten into the sprayer.	Allow the sprayer to dry out. Replace pump assembly and enclosure/SmartControl assembly.
Disinfectant leaks out of the cup threads.	Cup not properly seated.	Make certain that there is only one FlexLiner in Cup Support.
		Make certain the Cup Lid is properly threaded to the Cup Support. If threads are visible below the Cup Support when tight, fully remove the Cup Lid and reinstall to the Cup Support so no threads are visible when tight.
		Make certain the Cup Lid is tightened to the Cup Support so the arrow on the Cup Lid is within range of the indicator on the Cup Support.
		Avoid flexing or pushing on the Cup Support when you evacuate the air out of the FlexLiner.
		Avoid pulling down on the FlexLiner when you evacuate the air out of the FlexLiner.
		Make certain there is no damage to the FlexLiner lip or the Cup Lid gasket.
		Make certain the FlexLiner lip and Cup Lid gasket are free of debris.
		Replace FlexLiner.

Parts

25R791 Cordless Airless Handheld

 Torque to 55-65 in-lb
(6.2-7.3 N•m)

 Torque to 23-25 in-lb
(2.6-2.8 N•m)

 Torque to 10-15 in-lb
(1.1-1.7 N•m)

 Torque to 10 in-lb
(1.1 N•m)

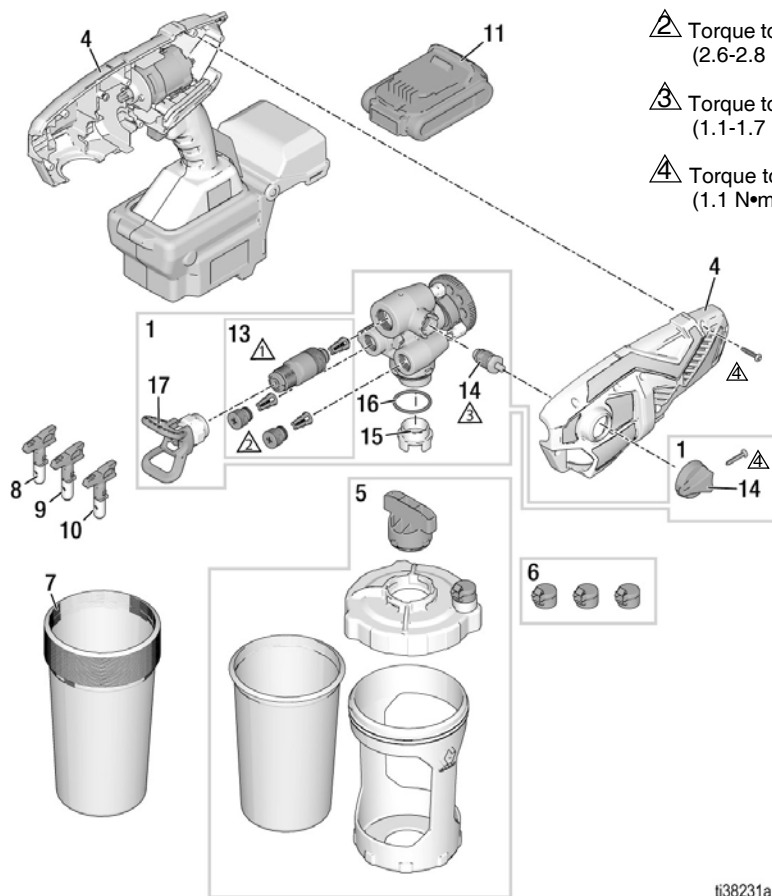

ti38231a

Parts List - 25R791 Cordless Airless Handheld

Ref. Part	Description	Qty.	Ref. Part	Description	Qty.
1	19Y967 KIT, pump, assembly	1	19†	25T283 KIT, adapter, extension (not shown)	1
4	19Y968 KIT, SmartControl with enclosure, 120V	1	20▲	19Y969 KIT, label, warning, HP 20 DC (not shown)	1
5	17P552 KIT, cup assembly, 42 oz.	1	21*	25R872 SEALS, polymer (5-pack) (not shown)	1
6	17P712 CAP (3-pack)	1	22▲	179960 CARD, medical alert (not shown)	1
7	17P549 FLEXLINER, 42 oz. (25-pack)	1			
8	LP313 TIP, LP313	1			
9	LP515 TIP, LP515	1			
10	LP619 TIP, LP619	1			
11◆	17P474 BATTERY, lithium ion compact, DeWalt	1			
12◆	17P475 CHARGER, lithium ion, DeWalt (not shown)	1			
13	25T375 KIT, valves, HP20	1			
14	25T398 KIT, prime valve, cordless	1			
15	17P554 FILTER, pump, 60 mesh (3-pack)	1			
16	16Y425 O-RING, pump inlet	1			
17	25R871 GUARD, spray tip, HP 20 (tip not included)	1			
18	25T282 KIT, extension, 15 inch (not shown)	1			

◆ *Battery and charger are dependent upon in country requirements.*

▲ *Replacement safety labels, tags, and cards are available at no cost.*

† *25T283 Adapter is required to connect 25T282 Extension onto SaniSpray HP 20 Airless Handheld.*

* *Two extra TipSeals (polymer spray tip seals) are included with the sprayer. For disinfectant applications, use TipSeal (polymer spray tip seal) instead of the OneSeal (metal seal) that is included with the replacement spray tips.*

Technical Specifications

Technical Specifications

SaniSpray HP 20 Cordless Airless Handheld		
	U.S.	Metric
Max Working Pressure	1000 psi	6.9 MPa, 69 bar
Weight	5.25 lb	2.4 kg
Dimensions:		
Length	14.0 in.	36.1 cm
Width	5 in.	12.7 cm
Height	11.8 in.	30.0 cm
Storage Temperature Range ♦*	32° to 113° F	0° to 45° C
Operating Temperature Range	40° to 90° F	4° to 32° C
Storage Humidity Range	0% to 95% relative humidity, non-condensing	
Sound Pressure Level	83.0 dBA	
Sound Power Level †	94.0 dBA Uncertainty K = 3 dBA	
Vibration level (Measured in accordance with EN 50580:2012)	Vibration total value $a_h = 21.5 \text{ ft/s}^2$ Uncertainty K = 0.3 ft/s^2	Vibration total value $a_h = 6.5 \text{ m/s}^2$ Uncertainty K = 0.1 m/s^2
Charger Power Source	100 – 120 Vac, 50 Hz, 15A, 1 Ø	
Battery		
Voltage (DC)	20 V MAX* 2.0 Ah Li-ion Compact Battery Pack DEWALT	
Maximum tip orifice	0.019 in.	0.48 mm
Notes		
♦ Pump damage will occur if disinfectant or water freezes in pump.		
* Damage to plastic parts may result if impact occurs in low temperature conditions.		
† All readings were taken in priming mode at the assured operator position. Sound power levels were tested to ISO 3741 at 3.3 feet (1m).		
* Maximum initial Battery voltage (measured without a workload) is 20 volts. Nominal voltage is 18.		

California Proposition 65

CALIFORNIA RESIDENTS

 **WARNING:** Cancer and reproductive harm –
www.P65warnings.ca.gov.

Graco Limited Warranty

Graco warrants all equipment referenced in this document which is manufactured by Graco and bearing its name to be free of defects in material and workmanship on the date of sale by an authorized Graco distributor to the original purchaser for use. Graco will, for a period of ninety (90) days from the date of sale, provide repair parts for equipment determined by Graco to be defective. This warranty applies only when the equipment is installed, operated and maintained in accordance with Graco's written recommendations.

This warranty does not cover, and Graco shall not be liable for general wear and tear, or any malfunction, damage or wear caused by faulty installation, misapplication, abrasion, corrosion, inadequate or improper maintenance, negligence, accident, tampering, or substitution of non-Graco component parts. Nor shall Graco be liable for malfunction, damage or wear caused by the incompatibility of Graco equipment with structures, accessories, equipment or materials not supplied by Graco, or the improper design, manufacture, installation, operation or maintenance of structures, accessories, equipment or materials not supplied by Graco.

THIS WARRANTY IS EXCLUSIVE, AND IS IN LIEU OF ANY OTHER WARRANTIES, EXPRESS OR IMPLIED, INCLUDING BUT NOT LIMITED TO WARRANTY OF MERCHANTABILITY OR WARRANTY OF FITNESS FOR A PARTICULAR PURPOSE.

Graco's sole obligation and buyer's sole remedy for any breach of warranty shall be as set forth herein. The buyer agrees that no other remedy (including, but not limited to, incidental or consequential damages for lost profits, lost sales, injury to person or property, or any other incidental or consequential loss) shall be available. Any action for breach of warranty must be brought within two (2) years of the date of sale.

GRACO MAKES NO WARRANTY, AND DISCLAIMS ALL IMPLIED WARRANTIES OF MERCHANTABILITY AND FITNESS FOR A PARTICULAR PURPOSE, IN CONNECTION WITH ACCESSORIES, EQUIPMENT, MATERIALS OR COMPONENTS SOLD BUT NOT MANUFACTURED BY GRACO.

These items sold, but not manufactured by Graco (such as electric motors, switches, hose, etc.), are subject to the warranty, if any, of their manufacturer. Graco will provide purchaser with reasonable assistance in making any claim for breach of these warranties.

IN NO EVENT WILL GRACO BE LIABLE FOR INDIRECT, INCIDENTAL, SPECIAL OR CONSEQUENTIAL DAMAGES RESULTING FROM GRACO SUPPLYING EQUIPMENT HEREUNDER, OR THE FURNISHING, PERFORMANCE, OR USE OF ANY PRODUCTS OR OTHER GOODS SOLD HERETO, WHETHER DUE TO A BREACH OF CONTRACT, BREACH OF WARRANTY, THE NEGLIGENCE OF GRACO, OR OTHERWISE.

This warranty gives you specific legal rights, and you may also have other rights which vary by country, state or province. This warranty and limitation of liability shall not exclude or limit those rights (if any) against Graco which cannot be excluded or limited under the applicable law of your country, state or province.

FOR GRACO NORTH AMERICA CUSTOMERS

Please call 1-844-241-9499 or visit www.graco.com/techsupport regarding any potential defect in equipment under warranty. If the claimed defect is verified, Graco will either, at its discretion, send repair parts for owner installation or replace the product, free of charge. Warranty claims and/or service for this product are not administered by Graco's distributors or service centers for Graco paint equipment.

FOR GRACO EUROPE, MIDDLE EAST, AFRICA AND ASIA PACIFIC CUSTOMERS

Please contact your regional service center or authorized distributor to administer a warranty claim.

FOR GRACO CANADA CUSTOMERS

The Parties acknowledge that they have required that the present document, as well as all documents, notices and legal proceedings entered into, given or instituted pursuant hereto or relating directly or indirectly hereto, be drawn up in English. Les parties reconnaissent avoir convenu que la rédaction du présente document sera en Anglais, ainsi que tous documents, avis et procédures judiciaires exécutés, donnés ou intentés, à la suite de ou en rapport, directement ou indirectement, avec les procédures concernées.

Graco Information

For the latest information about Graco products, visit www.graco.com.

For patent information, see www.graco.com/patents.

TO PLACE AN ORDER, contact your Graco distributor or call 1-800-690-2894 to identify the nearest distributor.

DEWALT® and the DEWALT Logo are trademarks of DEWALT Industrial Tool Co.
and are used under license

All written and visual data contained in this document reflects the latest product information available at the time of publication. Graco reserves the right to make changes at any time without notice.

Original instructions. This manual contains English. MM 3A7649

Graco Headquarters: Minneapolis

International Offices: Belgium, China, Japan, Korea

GRACO INC. AND SUBSIDIARIES • P.O. BOX 1441 • MINNEAPOLIS MN 55440-1441 • USA

Copyright 2020, Graco Inc. All Graco manufacturing locations are registered to ISO 9001.

www.graco.com

Revision B, June 2020