



JGA-510 CONVENTIONAL SPRAY GUN

IMPORTANT: Before using this equipment, read all safety precautions and instructions. Keep for future use.

DESCRIPTION

The JGA-510 can be utilized with the wide range of air caps and needles. It is a general purpose, heavy duty, high production spray gun suitable for use with most types of materials. The fluid tip and needle and internal fluid passages are stainless steel.

Conversion to HVLP - The JGA-510, plus JGA-503 models, can be converted to HVLP if desired. Contact DeVilbiss for information.

Note

This gun includes 300 series stainless steel fluid passages and 300/400 series tip and needle. Guns may be used with chlorinated solvent materials, but see page 2 for additional warnings.

Important: This gun may be used with most common coating and finishing materials. It is designed for use with mildly corrosive and non-abrasive materials. If used with other high corrosive or abrasive materials, it must be expected that frequent and thorough cleaning will be required and the necessity for replacement of parts will be increased.

OPERATION

Note

Protective coating and rust inhibitors have been used to keep the gun in good condition prior to shipment. Before using the gun, flush it with solvent so that these materials will be removed from fluid passages.

Strain material thru 60 or 90 mesh screen. Adjust fluid pressure to deliver the desired paint volume. Adjust air pressure and flow to provide a uniform dispersion of atomized paint throughout the pattern. Keep air pressure as low as possible to minimize bounce - back and overspray. Excessive fluid flow will result in heavy center spray patterns. Inadequate flows may cause the pattern to split. See "Troubleshooting", Page 6, if any problems occur.

PREVENTIVE MAINTENANCE

To clean air cap and fluid tip, brush exterior with a stiff bristle brush. If necessary to clean cap holes, use a broom straw or toothpick. **Never use a wire or hard instrument.** This may scratch or burr holes causing a distorted spray pattern.

To clean fluid passages, remove excess material at source, then flush with a suitable solvent using a device such as the SolventSaver™ (see Accessories). Wipe gun exterior with a solvent dampened cloth. Never completely immerse in solvent as this is detrimental to the lubricants and packings.

Note

When replacing the fluid tip or fluid needle, replace both at the same time. Using worn parts can cause fluid leakage. Also, replace the needle packing at this time. Lightly lubricate the threads of the fluid tip before reassembling. Torque to 20-25 ft. lbs. Do not overtighten the fluid tip.



To prevent damage to the fluid tip (4) or fluid needle (33), be sure to either 1) pull the trigger and hold while tightening or loosening the fluid tip or 2) remove fluid needle adjusting screw (28) to relieve spring pressure against needle collar.

SPRAY GUN LUBRICATION

Daily, apply a drop of SSL-10 spray gun lube at trigger bearing stud (21) and the stem of the air valve (13) where it enters the air valve assembly (17). The shank of the fluid needle (33) where it enters the packing nut (19) should also be oiled. The fluid needle packing (18) should be lubricated periodically. Make sure the baffle (6) and retaining ring (1 or 2) threads are clean and free of foreign matter. Before assembling retaining ring to baffle, clean the threads thoroughly, then add two drops of SSL-10 spray gun lube to threads. The fluid needle spring (30) and air valve spring (12) should be coated with a very light grease, making sure that any excess grease will not clog the air passages. For best results, lubricate the points indicated, daily.

- A. Trigger Points
- B. Packing
- C. Adjusting Valves
- D. Baffle Threads
- E. Air Valve Cartridge

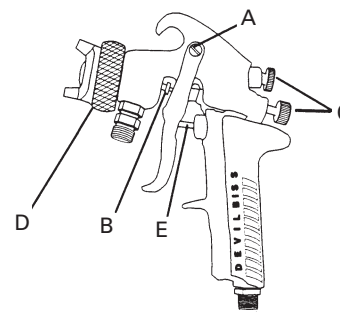

FLUID INLET GASKET (7) REPLACEMENT INSTRUCTIONS

1. Remove fluid inlet adapter with appropriate wrench.
2. Clean Loctite from gun body inlet threads and seal area.
3. Place gasket (7) squarely onto the fluid inlet adapter and push it down until it is flat against the boss.
4. Place a couple of drops of medium strength blue No. 242 Loctite on threads before installing fluid inlet adapter.
5. Torque fluid inlet adapter to 20-25 ft. lbs., and tighten locknut.

SAFETY PRECAUTIONS

This manual contains information that is important for you to know and understand. This information relates to USER SAFETY and PREVENTING EQUIPMENT PROBLEMS. To help you recognize this information, we use the following symbols. Please pay particular attention to these sections.

WARNING

Important safety information - A hazard that may cause serious injury or loss of life.

CAUTION

Important information that tells how to prevent damage to equipment, or how to avoid a situation that may cause minor injury.

Note

Information that you should pay special attention to.

WARNING

**The following hazards may occur during the normal use of this equipment.
Please read the following chart before using this equipment.**





HAZARD	CAUSE	SAFEGUARDS
Fire 	Solvent and coatings can be highly flammable or combustible especially when sprayed. Smoking must never be allowed in the spray area. Fire extinguishing equipment must be present in the spray area.	Adequate exhaust must be provided to keep air free of accumulations of flammable vapors.
Solvent Spray 	During use and while cleaning and flushing, solvents can be forcefully expelled from fluid and air passages. Some solvents can cause eye injury.	Wear eye protection.
Inhaling Toxic Substances 	Certain materials may be harmful if inhaled, or if there is contact with the skin.	Follow the requirements of the Material Safety Data Sheet supplied by your coating material manufacturer. Adequate exhaust must be provided to keep the air free of accumulations of toxic materials. Use a mask or respirator whenever there is a chance of inhaling sprayed materials. The mask must be compatible with the material being sprayed and its concentration. Equipment must be as prescribed by an industrial hygienist or safety expert, and be NIOSH approved.
Explosion Hazard - Incompatible Materials 	Halogenated hydrocarbon solvents - for example; methylene chloride and 1, 1, 1 - Trichloroethylene are not chemically compatible with the aluminum that might be used in many system components. The chemical reaction caused by these solvents reacting with aluminum can become violent and lead to an equipment explosion.	Guns with stainless steel internal passageways may be used with these solvents. However, aluminum is widely used in other spray application equipment - such as material pumps, regulators, valves and cups. Check all equipment items before use and make sure they can also be used safely with these solvents. Read the label or data sheet for the material you intend to spray. If in doubt as to whether or not a coating or cleaning material is compatible, contact your material supplier.
General Safety	Improper operation or maintenance of equipment.	Operators should be given adequate training in the safe use & maintenance of the equipment (in accordance with the requirements of NFPA-33, Chapter 15). Users must comply with all local and national codes of practice and insurance company requirements governing ventilation, fire precautions, operation, maintenance and housekeeping. These are OSHA Sections 1910.94 and 1910.107 and NFPA-33.
Cumulative Trauma Disorders ("CTD's") CTD's, or musculo-skeletal disorders, involve damage to the hands, wrist, elbows, shoulders, neck & back. Carpal tunnel syndrome & tendinitis (such as tennis elbow or rotator cuff syndrome) are examples of CTD's.	Use of hand tools may cause cumulative trauma disorders ("CTD's"). CTD's when using hand tools, tend to affect the upper extremities. Factors which may increase the risk of developing a CTD include: <ol style="list-style-type: none"> 1. High frequency of the activity. 2. Excessive force, such as gripping, pinching, or pressing with the hands and fingers. 3. Extreme or awkward finger, wrist, or arm positions. 4. Excessive duration of the activity. 5. Tool vibration. 6. Repeated pressure on a body part. 7. Working in cold temperatures. CTD's can also be caused by such activities as sewing, golf, tennis, bowling, to name a few.	Pain, tingling, or numbness in the shoulder, forearm, wrist, hands or fingers, especially during the night, may be early symptoms of a CTD. Do not ignore them. Should you experience any such symptoms, see a physician immediately. Other early symptoms may include vague discomfort in the hand, loss of manual dexterity, and nonspecific pain in the arm. Ignoring early symptoms and continued repetitive use of the arm, wrist and hand can lead to serious disability. Risk is reduced by avoiding or lessening factors 1-7.

CHART 1

Air Cap Sizes Order From Chart 2	NOZZLE COMBINATIONS								
	Fluid Tip and Needle Size Order From Chart 3								
	AC	D	E	EE	EX	FF	FX	FW	GX
Tip Orifice in./mm	.110 2.8	.080 2.2	.070 1.8	.070 1.8	.070 1.8	.055 1.4	.042 1.1	.063 1.6	.034 .9
24			P			P	P		
30			P		S	S	S	S	
58					S	P	P		P
62HD	P								
64HD		P							
67HD				P					
69HD		P							
80					S	S	S	S	
704			P			P	P		
765			P			P	P		
777			P			P			
797			P			P			
9000					S	S		S	S

P = Pressure Feed Combination
S = Suction Feed Combinations

CHART 3

FLUID TIPS AND NEEDLES		
Tip Orifice Size In. / (mm)	Ref. No. 4 Fluid Tip	Ref. No. 33 Fluid Needle
303 GR. S.S. TIPS AND 303 GR. S.S. NEEDLES		
.110 (2.8)	AV-2115-AC	JGA-402-C
.086 (2.2)	AV-2115-D	JGA-402-DEX
.070 (1.8)	AV-2115-E	JGA-402-E
.070 (1.8)	AV-2115-EX	JGA-402-DEX
.055 (1.4)	AV-2115-FF	JGA-402-FF
.042 (1.1)	AV-2115-FX	JGA-402-FX
.063 (1.6)	AV-2115-FW	JGA-402-FF
.034 (.9)	AV-2115-GX	---
OPTIONAL 300 GR. S.S. W/ U.H.M.W. POLYETHYLENE NEEDLE SEAT		
.086 (2.2)	AV-4915-D	---
.070 (1.8)	AV-4915-E	---
.055 (1.4)	AV-4915-FF	---
.042 (1.1)	AV-4915-FX	---
.028 (.8)	AV-4915-G	---
OPTIONAL CARBOLOY TIPS AND NEEDLES		
.086 (2.2)	AV-1415-D	JGA-409-D
.070 (1.8)	AV-1415-EE	JGA-409-DEEE
.055 (1.4)	AV-1415-FF	JGA-409-FF

CHART 2

AIR CAPS		
No. on Cap Order →	Ref. No. (1) Air Cap With Ring	Ref. No. (3) Air Cap Less Ring*
24		AV-40-24
30	MB-4039-30	
58	AV-439-58	
62HD	MB-4039-62HD	
64HD	MB-4039-64HD	
67HD	MB-4039-67HD	
69HD	MB-4039-69HD	
80	MB-4039-80	
704		AV-1239-704
765		AV-1239-765
777		31767-777
797		AV-1239-797
9000	AV-440-9000	

*MBC-368 Retaining Ring (sold separately) is required to mount Air Cap to Gun.

PARTS LIST

Ref. No.	Replacement Part No.	Description	Individual Parts Required
1	See Chart 2	Air Cap w/ Retaining Ring	1
2	MBC-368	Retaining Ring	1
3	See Chart 2	Air Cap Less Retaining Ring	1
4	See Chart 3	Fluid Tip	1
*5	GTI-33-K5	Seal Kit (Kit of 5)	1
6	GTI-425	Baffle Assembly	1
7	MSV-3-K10	Fluid Inlet Gasket (Kit of 10) PTFE (blue)	1
8	---	Lock Nut	1
9	---	Fluid Inlet Adapter	1
10	JGA-4044	Fluid Inlet and Nut Kit	1
*11	JGS-72-K10	Gasket Kit (Kit of 10) (PTFE)	2
*12	MBD-12-K25	Spring Kit (Kit of 25)	1
*13	JGS-431-K25	Air Valve Kit (Kit of 25)	1
*14	JGS-26-K25	U Cup Seal Kit (Kit of 25)	1
*15	JGA-15-K25	Washer Kit (Kit of 25)	1
*16	JGA-14-K25	Snap Ring Kit (Kit of 25)	1
17	JGS-449-1	Air Valve Assembly	1
*18	JGV-463-K3	Packing Kit (Kit of 3)	1
19	34411-122-K10	Packing Nut Kit (Kit of 10)	1
*20	---	Screw	1
21	JGS-478	Stud and Screw Kit (Kit includes 3 studs and 5 screws)	1
22	JGS-477-1	Trigger, Stud and Screw Kit (Kit includes 1 each)	1
23	JGA-132	Plug	1
24	P-MB-51	Nipple	1
25	JGA-497-1	Fan Adjustment Assembly	1
*26	---	Retaining Ring	1
*27	SSG-8069-K25	O-Ring (Viton) (Kit of 25)	1
28	JGS-16	Adjusting Screw	1
*29	---	Spring Pad (Included with # 30 and 32)	1
*30	MBD-19-K10	Spring Kit (Kit of 10)	1
31	---	Bushing	1
32	JGA-4041	Bushing, Spring Pad and Knob Kit	1
33	See Chart 3	Fluid Needle	1
34	---	Gun Body	1

* A quantity of necessary parts is included in Major Repair Kit ■KK-4987-2 for complete gun repair and should be kept on hand for service convenience.

Suffixes - K10 designates kits of multiple parts. (Example) JGS-72-K10 is a kit of 10 gaskets.

■ Government NSN No. 4940-01-046-9919 = KK-4987-2.

GTI-33 Baffle Seal Replacement (5)

1. Remove fluid tip (4).
2. Remove baffle (6).
3. Remove seal (5) from baffle.
4. Assemble seal to baffle with **angled side up** as shown at right.
5. Install baffle on gun.
6. Install fluid tip (4) and tighten to 12-15 ft-lbs.

NOTE

The seal should be a tight fit on the baffle. If it is a loose fit on the baffle, assure that it is assembled with the angled side up.



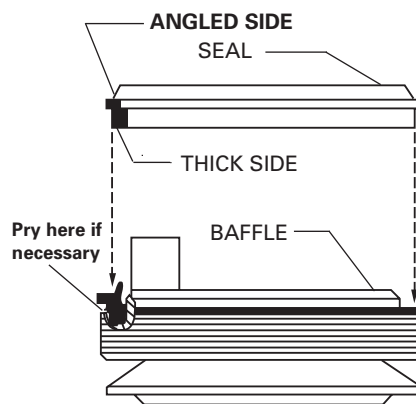

NOTE

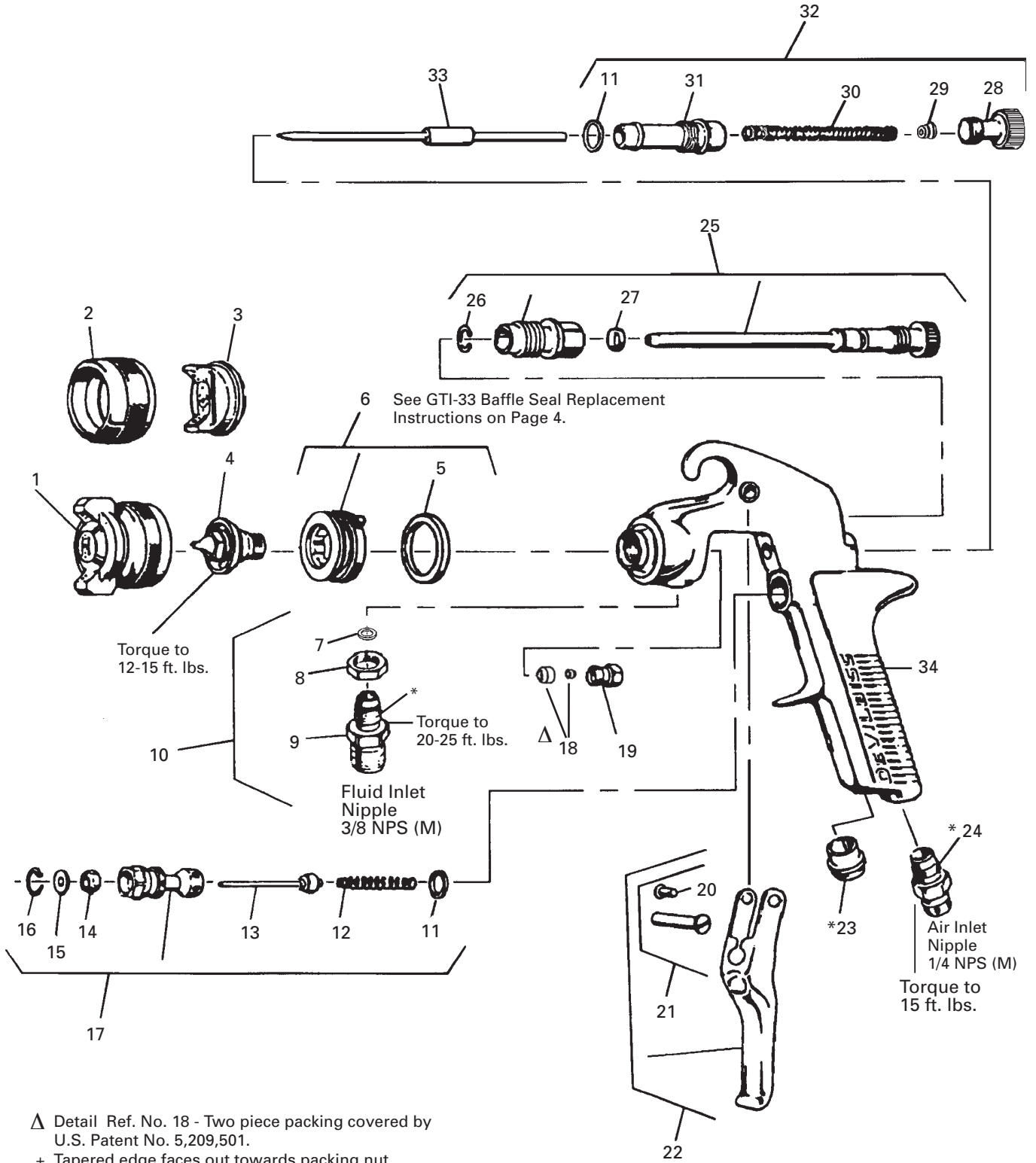
The seal is designed to be a tight fit on the baffle. The seal should be able to be removed using your fingers. If you are unable to remove the seal using your fingers, insert a small screwdriver between the outer lip and the back of the baffle and pry the seal off.





TROUBLESHOOTING











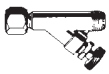

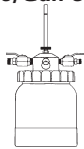
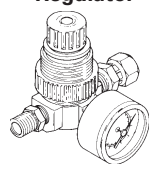

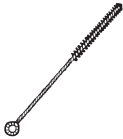
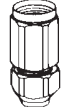
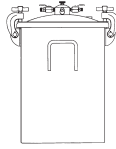
CONDITION	CAUSE	CORRECTION
Heavy top or bottom pattern 	Horn holes plugged. Obstruction on top or bottom of fluid tip. Cap and/or tip seat dirty.	Clean. Ream with non-metallic point. Clean. Clean.
Heavy right or left side pattern 	Left or right side horn holes plugged. Dirt on left or right side of fluid tip. Remedies for the top-heavy, bottom-heavy, right-heavy and left-heavy patterns: 1) Determine if the obstruction is on the air cap or the fluid tip. Do this by making a test spray pattern. Then, rotate the cap one-half turn and spray another pattern. If the defect is inverted, obstruction is on the air cap. Clean the air cap as previously instructed. 2) If the defect is not inverted, it is on the fluid tip. Check for a fine burr on the edge of the fluid tip. Remove with #600 wet or dry sand paper. 3) Check for dried paint just inside the opening. Remove paint by washing with solvent.	Clean. Ream with non-metallic point. Clean.
Heavy center pattern 	Fluid pressure too high for atomization air (pressure feed). Material flow exceeds air cap's capacity. Atomizing pressure too low. Material too thick.	Balance air and fluid pressure. Increase spray pattern width with spreader adjustment valve. Thin or lower fluid flow. Spreader adjustment valve set too low. Adjust. Increase pressure. Thin to proper consistency.
Split spray pattern 	Atomization air pressure too high. Fluid pressure too low (pressure feed only). Spreader adjusting valve set too high.	Reduce at transformer or gun. Increase fluid pressure (increases gun handling speed). Adjust.
Jerky or fluttering spray 	*Loose or damaged fluid tip/seat. Material level too low. Container tipped too far. Obstruction in fluid passage. Loose or broken fluid tube or fluid inlet nipple. Dry or loose fluid needle packing nut.	Tighten or replace. Refill. Hold more upright. Backflush with solvent. Tighten or replace. Lubricate or tighten.
Unable to get round spray	Spreader adjustment screw not seating properly. Air cap retaining ring loose.	Clean or replace. Tighten.
Will not spray	No air pressure at gun. Internal mix or pressure feed air cap and tip used with suction feed. Fluid pressure too low with internal mix cap and pressure tank. Fluid needle adjusting screw not open enough. Fluid too heavy for suction feed.	Check air supply and air lines. Change to proper suction feed air cap and tip. Increase fluid pressure at tank. Open fluid needle adjusting screw. Thin material or change to pressure feed.
Starved spray pattern	Inadequate material flow. Low atomization air pressure (suction feed).	Back fluid adjusting screw out to first thread or increase fluid pressure at tank. Increase air pressure and rebalance gun.
Excessive overspray	Too much atomization air pressure Gun too far from work surface. Improper stroking (arcing, gun motion too fast).	Reduce pressure. Adjust to proper distance. Move at moderate pace, parallel to work surface.
Excessive fog	Too much, or too fast-drying thinner. Too much atomization air pressure.	Remix properly. Reduce pressure.
Dry Spray	Air pressure too high. Gun tip too far from work surface. Gun motion too fast. Gun out of adjustment.	Reduce air pressure. Adjust to proper distance. Slow down. Adjust.
Fluid leaking from packing nut	Packing nut loose. Packing worn or dry.	Tighten, do not bind needle. Replace or lubricate.
Fluid leaking or dripping from front of pressure feed gun	Packing nut too tight. Dry packing. Fluid tip or needle worn or damaged. Foreign matter in tip. Fluid needle spring broken. Wrong size needle or tip.	Adjust Lubricate. Replace tip and needle with lapped sets. Clean. Replace. Replace.

*Most common problem.

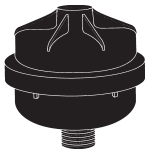
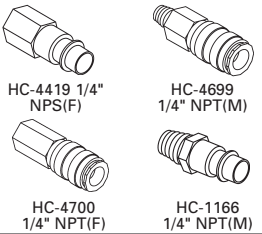
TROUBLESHOOTING (continued)

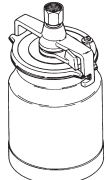
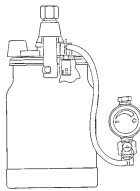
CONDITION	CAUSE	CORRECTION
Runs and sags	Too much material flow. Material too thin. Gun tilted on an angle, or gun motion too slow.	Adjust gun or reduce fluid pressure. Mix properly or apply light coats. Hold gun at right angle to work and adapt to proper gun technique.
Thin, sandy coarse finish drying before it flows out	Gun too far from surface. Too much air pressure. Improper thinner being used.	Check distance. Normally approximately 8". Reduce air pressure and check spray pattern. Follow paint manufacturer's mixing instructions.
Thick, dimpled finish "orange peel".	Gun too close to surface. Too much material coarsely atomized. Air pressure too low. Improper thinner being used. Material not properly mixed. Surface rough, oily, dirty.	Check distance. Normally approximately 8". Increase air pressure or reduce fluid pressure. Increase air pressure or reduce fluid pressure. Follow paint manufacturer's mixing instructions. Follow paint manufacturer's mixing instructions. Properly clean and prepare surface.

ACCESSORIES

<p>P-H-5516 Air Adjusting Valve</p>  <p>Enables user to control and reduce air usage at the gun. Ideal for low pressure spraying.</p>	<p>HAV-500 or HAV-501 Adjusting Valve (HAV-501 SHOWN)</p>  <p>HAV-500 does not have pressure gage. Use to control air usage at gun.</p>	<p>HD-503 SolventSaver™ Hose/Gun Cleaner</p>  <p>2 Qt Hose/Gun Cleaner used to clean the inside of hose, fluid passageways of gun & other paint equipment.</p>	<p>HARG-510 Air Regulator</p>  <p>Use to maintain nearly constant outlet pressure despite changes in inlet pressure and downstream flow.</p>	<p>JGA-4035-K5 Optional 3 Piece Packings</p>  <p>This 3 piece packing can be used in place of Ref. (18) JGV-463, 2 piece packing.</p>	<p>JGA-52-K10 Leather Packings</p>  <p>Used when abrasive materials are sprayed (i.e. porcelain enamel). Use (2) JGA-52 packings in place of JGV-463 packing.</p>
<p>42884-214-K5 3/8" 42884-215-K10 5/8" Cleaning Brushes</p>  <p>These brushes are helpful in cleaning threads and recesses of gun body.</p>	<p>VS-531 Low Pressure Strainers</p>  <p>The VS-531 Low Pressure Fluid Strainer provides a final filter for trapping foreign particles in the paint supply.</p>	<p>83GZ-5200 SolventSaver™ Hose/Gun Cleaner</p>  <p>2 Gallon galvanized tank used to clean the inside of hose and material passages of the gun.</p>	<p>GTI-415 Air Adjusting Valve</p>  <p>Installs into gun to enable user to control and reduce air usage at the gun. Replaces JGA-132 plug.</p>	<p>Spray Gun Lube SSL-10 (2 oz. bottle)</p>  <p>Compatible with all paint materials: contains no silicone or petroleum distillates to contaminate paint. MSDS sheet available upon request.</p>	<p>MSA-4-K10 Fluid Needle Spring (replaces MBD-19)</p>  <p>Provides reduced spring force (4 lbs. verses 6 lbs.) for easier trigger pull.</p>
<p>JGA-156-K10 Spring Clip</p>  <p>Joins any single piece DeVilbiss air cap MBC-368 or MSA-1 retaining ring. Helps prevent parts loss and provides easier assembly.</p>	<p>HAF-507 Whirlwind™ In-Line Air Filter</p>  <p>Removes water, oil, and debris from the air line.</p>	<p>Quick Disconnect Approved for HVLP Guns (Air) High Flow Ball and Ring Type</p>  <p>HC-4419 1/4" NPS(F) HC-4699 1/4" NPT(M) HC-4700 1/4" NPT(F) HC-1166 1/4" NPT(M)</p>	<p>KB-555 (Aluminum) & KB-545-SS (S/S) 2 qt. Pressure Feed Cup With Regulator</p>  <p>Provides greater degree of control over cup fluid pressure.</p>	<p>JGA-191-K2 Heavy Duty Spring (for zinc rich materials)</p> 	
<p>TGC-545 (Aluminum) TLC-555 (Non-stick Lined) TSC-595 S.S. 2 Qt. Drip-Free Suction Cup</p>  <p>Cup has a unique, two position valve which permits selection of either a drip-free or conventional open vent mode.</p>		<p>TLC-576 Aluminum Cup (Non-stick Lined) & TSC-591 Stainless Steel Cup</p>  <p>1 Qt. pressure feed cups. 3/8" NPS (F), cam lock lid. Requires KK-4980 air regulator kit.</p>		<p>29-3100 Scrubs® Hand Cleaner Towels</p>  <p>Scrubs® are a pre-moistened hand cleaner towel for painters. No water is needed.</p>	<p>Millennium 3000 Twin Cartridge Paint Spray Respirator</p> 
<p>JGA-444 Fluid Tube</p> <p>This tube combines the fluid and air hoses at gun handle preventing dragging hoses over work, twisting line and improving overall gun handling.</p>		<p>WR-103 Wrench</p> <p>Contains all necessary tip, hose and nut sizes used on or with gun.</p> 			<p>NIOSH-Certified, for respiratory protection in atmospheres not immediately dangerous to life.</p>

WARRANTY POLICY

DeVilbiss products are covered by Finishing Brands one year materials and workmanship limited warranty. The use of any parts or accessories, from a source other than Finishing Brands, will void all warranties. For specific warranty information please contact the closest Finishing Brands location listed below.

Finishing Brands reserves the right to modify equipment specifications without prior notice. DeVilbiss, Ransburg, BGK, and Binks are registered trademarks of Finishing Brands. ©2014 Finishing Brands. All rights reserved.

DEVILBISS

DeVilbiss is part of Finishing Brands, a global leader in innovative spray finishing technologies. For technical assistance or to locate an authorized distributor, contact one of our international sales and customer support locations below.

USA/Canada

www.devilbiss.com
info@finishingbrands.com
Tel: 1-800-992-4657
Fax: 1-888-246-5732

Mexico

www.finishingbrands.com.mx
sales@finishingbrands.com.mx
Tel: 011 52 55 5321 2300
Fax: 011 52 55 5310 4790

Brazil

www.devilbiss.com.br
sales@devilbiss.com.br
Tel: +55 11 5641 2776
Fax: 55 11 5641 1256

United Kingdom

www.finishingbrands.eu
info@finishingbrands.eu
Tel: +44 (0)1202 571 111
Fax: +44 (0)1202 573 488

France

www.finishingbrands.eu
info@finishingbrands.eu
Tel: +33(0)475 75 27 00
Fax: +33(0)475 75 27 59

Germany

www.finishingbrands.eu
info@finishingbrands.eu
Tel: +49 (0) 6074 403 1
Fax: +49 (0) 6074 403 281

China

www.finishingbrands.com.cn
mkt@finishingbrands.com.cn
Tel: +8621-3373 0108
Fax: +8621-3373 0308

Japan

www.ransburg.co.jp
binks-devilbiss@ransburg.co.jp
Tel: 081 45 785 6421
Fax: 081 45 785 6517

Australia

www.finishingbrands.com.au
sales@finishingbrands.com.au
Tel: +61 (0) 2 8525 7555
Fax: +61 (0) 2 8525 7500

DEVILBISS

Ransburg

BGK

BINKS

Finishing Brands