

ProControl™ 1KS

3A1080H
EN

Automatic system for fluid management of single component coatings. Includes flow control, flushing, and color change. For professional use only.

Approved for use in explosive atmospheres (except the EasyKey).



Important Safety Instructions

Read all warnings and instructions in this manual. Save these instructions.

See pages 4-5 for model information, including maximum working pressure. Equipment approval labels are on page 3. Some components shown are not included with all systems.

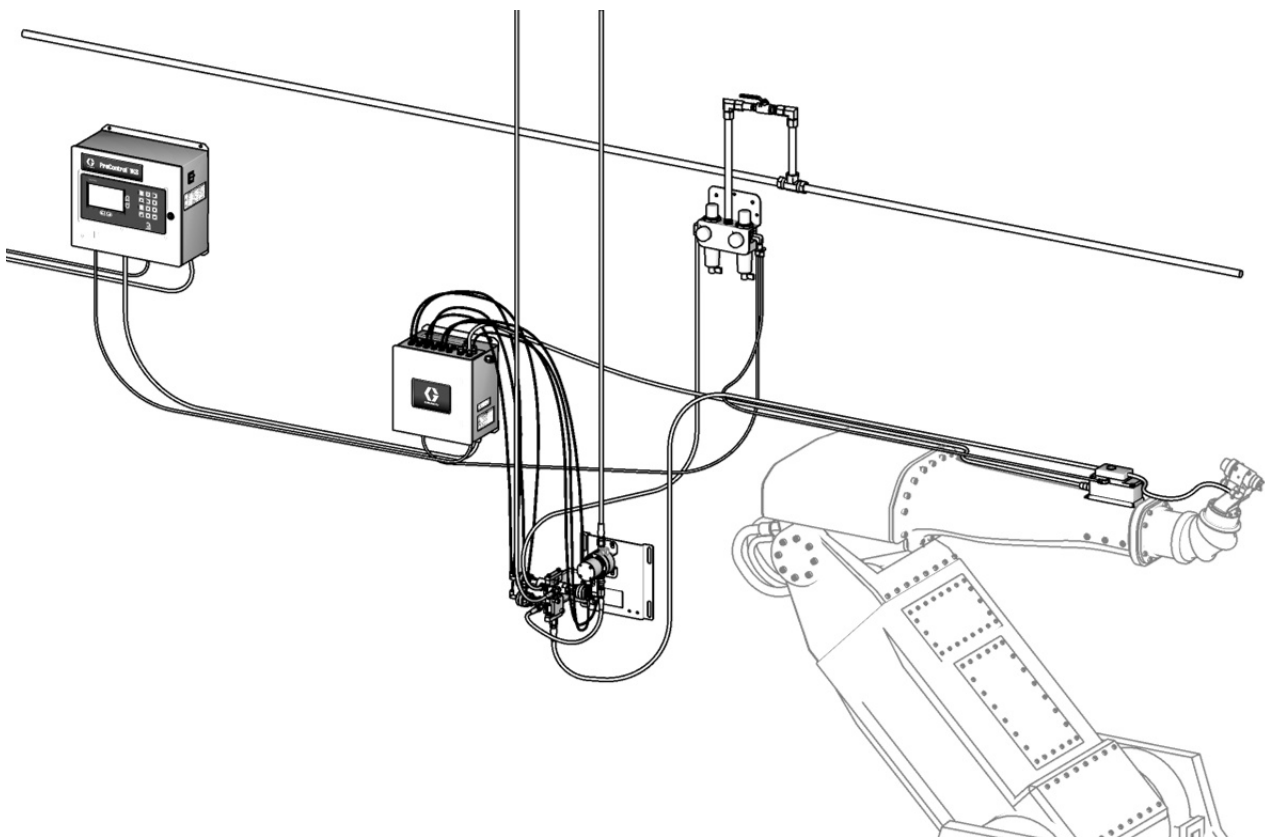

T116328a



Contents

Related Manuals	3	Modbus and I/O Data	66
Equipment Approvals	3	Start Mix Process	66
System Configuration and Part Numbers	4	Stop Mix Process	66
Models	4	Color Change Process	66
Standard Features	5	Purge Process	66
Accessories	5	67
Warnings	6	Typical PLC Interaction with ProControl 1KS	69
Important Two-Component Material Information	8	Integrated Flow Control	78
Isocyanate Conditions	8	Flow Control Description	78
Material Self-ignition	8	Flow Control Components	78
Keep Components A and B Separate	8	Fluid and Air Pressure Requirements	79
Moisture Sensitivity of Isocyanates	8	Flow Control Operation	79
Changing Materials	8	Flow Control Operating Process Example	81
Glossary of Terms	9	Flow Control Setup	83
Overview	12	Flow Control Startup	83
Usage	12	One-Point Learning	84
Component Identification and Definition	12	Flow Control Calibration	85
Wall Mount System Components	14	Pressure Flow Control Mode	88
EasyKey Display and Keypad	16	Flow Control Troubleshooting	89
Display	16	System Operation	91
Keypad	16	Operation Modes	91
AC Power Switch	18	Recipe (Color) Change	91
I/S Power	18	Solvent Push	91
Audible Alarm	18	Mix Manifold Valve Settings	91
Graco Web Interface Port	18	Start Up	92
Ethernet Connection	18	Shutdown	94
Run Mode Screens	19	Pressure Relief Procedure	94
Splash Screen	19	Purging	98
Status Screen	21	Solvent Push Feature	101
Manual Override Screen	22	Meter Calibration	102
Totals Screen	23	Color Change	104
Reset Total Screen	23	Color Change Procedures	104
Reset Solvent Screen	23	Color Change Sequences	104
Alarms Screen	24	Alarms and Warnings	118
Level Control Screen	24	System Alarms	118
Setup Mode	25	System Warnings	118
Password Screen	26	Alarm Troubleshooting	119
Set Up Home Screen	26	Schematic Diagrams	130
System Configuration Screens	28	System Pneumatic Schematic	130
Option Screens	32	System Electrical Schematic	131
Advanced Setup Screens	34	EasyKey Electrical Schematic	133
Recipe Setup Screens	40	Meter Performance Data (G3000 on A and B)	134
Recipe 0 Screens	45	Meter Performance Data (G3000 on A, Coriolis on B)	135
Calibration Screen	47	Technical Data	137
ProControl Integration Specifics	49	Graco Standard Warranty	138
System Setup for Automatic Operation	49	Graco Information	138
Status Verification of Automatic Operation	50		
Discrete I/O vs Network Communications	50		
Discrete I/O	51		
Automation Flow Charts	55		

Related Manuals

Component Manuals in English

Manual	Description
3A1163	ProControl 1KS Installation
3A1164	ProControl 1KS Repair-Parts
312782	Dispense Valve
312783	Color Change Valve Stacks
312787	Color Change Module Kit
312784	Gun Flush Box Kits
310745	Gun Air Shutoff Kit
312786	Dump Valve and Third Purge Valve Kits
312785	Network Communication Kits
308778	G3000/G3000HR/G250/G250HR Flow Meter
313599	Coriolis Flow Meter
313212	Gun Flush Box Integration Kit
313290	Floor Stand Kit
313542	Beacon Kit
313386	Basic Web Interface/Advanced Web Interface
406800	15V825 Discrete I/O Board Kit

Equipment Approvals

Equipment approvals appear on the following labels which are attached to the Fluid Station Control Box and EasyKey™. See FIG. 1 on page 4 for label locations.

EasyKey and Fluid Station Control Box Label

ATEX Certificate is listed here

ProControl 1KS Electronic Proportioner

Intrinsically Safe (IS) System. Install per IS Control Drawing No. 289833. EasyKey Interface IS Associated Apparatus for use in non hazardous location, with IS Connection to Smart Fluid Plate IS Apparatus for use in: Class I, Division 1, Group D T3 C Hazardous Locations

Read Instruction Manual Warning: Substitution of components may impair intrinsic safety.

Part No. Series Serial

.7	7	100
MPa	bar	PSI

MAX AIR WPR

1.31	13.1	190
MPa	bar	PSI

MAX FLUID WPR

MAX TEMP 50°C (122°F)

CE 2575

FM US APPROVED Intrinsic safe equipment for Class I, Div 1, Group D, T3 Ta = -20°C to 50°C

Ex ia IIA T3

FM08ATEX0074

GRACO INC. P.O. Box 1441 Minneapolis, MN 55440 U.S.A.

Fluid Station Label

ProControl FLUID PANEL

Part No. Series Serial

.7	7	100
MPa	bar	PSI

MAX AIR WPR

CE 2575

FM US APPROVED Intrinsic safe equipment for Class I, Div 1, Group D, T3 Ta = -20°C to 50°C Install per 289833

Ex ia IIA T3

FM08ATEX0073

GRACO INC. P.O. Box 1441 Minneapolis, MN 55440 U.S.A.

293765b

ATEX Certificate is listed here

EasyKey Label

ProControl 1KS POWER REQUIREMENTS

Part No. Series No. Mfg. Yr.

277869		
--------	--	--

VOLTS 85-250 ~

AMPS 2 AMPS MAX

50/60 Hz

Um: 250 V

CE 2575

FM US APPROVED Intrinsic safe connections for Class I, Div 1, Group D Ta = -20°C to 50°C Install per 289833

Ex ia IIA

FM08ATEX0072

GRACO INC. P.O. Box 1441 Minneapolis, MN 55440 U.S.A.

293762b

ATEX Certificate is listed here

System Configuration and Part Numbers

Models

The part number for your equipment is printed on the equipment identification labels. See FIG. 1 for location of the identification labels.

Part No.	Series	Description	Meter			Flow Control	
			None	G3000	Coriolis	No	Yes
262380	A	ProControl 1KS	✓			✓	
262381	A	ProControl 1KS		✓		✓	
262382	A	ProControl 1KS		✓			✓
262383	A	ProControl 1KS			✓		✓

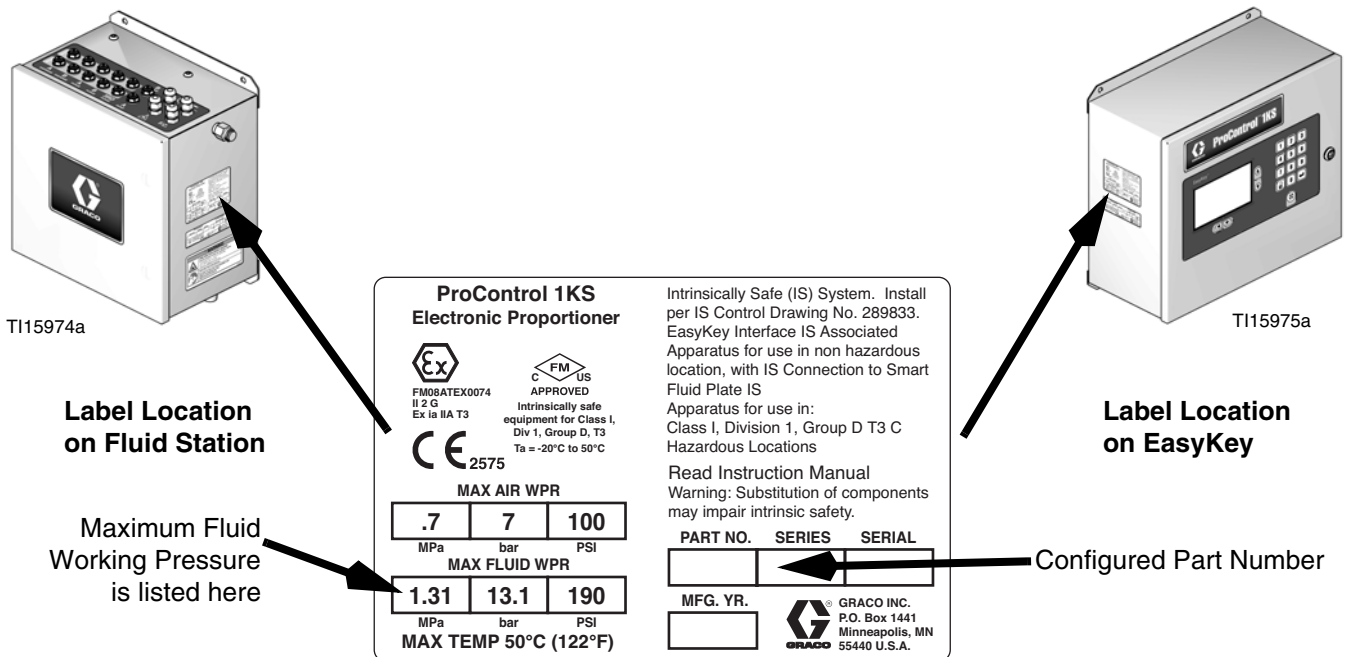

FIG. 1: Identification Label, ProControl 1KS Systems

Hazardous Location Approval

Models using a G3000, G3000HR, or intrinsically safe Coriolis meter are approved for installation in a Hazardous Location - Class I, Div I, Group D, T3 or Zone I Group IIA T3.

Maximum Working Pressure

Maximum working pressure rating is dependent on the fluid component options selected. **The pressure rating is based on the rating of the lowest rated fluid component.** Refer to the component pressure ratings below.
Example: Model 262383 has a maximum working pressure of 190 psi (1.31 MPa, 13.1 bar).

Check the identification label on the EasyKey or fluid station for the system maximum working pressure. See FIG. 1.

ProControl Fluid Components Maximum Working Pressure

Base System (no meter, no color/catalyst change option, and no flow control [option])	4000 psi (27.58 MPa, 275.8 bar)
G3000 Meter Option	4000 psi (27.58 MPa, 275.8 bar)
Coriolis Meter Option	2300 psi (15.86 MPa, 158.6 bar)
Color Change Option	300 psi (2.07 MPa, 20.6 bar)
Flow Control Option	190 psi (1.31 MPa 13.1 bar)

Flow Meter Fluid Flow Rate Range

G3000	75-3800 cc/min. (0.02-1.0 gal./min.)
G3000HR	38-1900 cc/min. (0.01-0.50 gal./min.)
Coriolis Meter	20-3800 cc/min. (0.005-1.00 gal./min.)
S3000 Solvent Meter (accessory)	38-1900 cc/min. (0.01-0.50 gal./min.)

Standard Features

Feature
EasyKey with LCD
RS 485 Network Cable, 50 ft (15.25 m)
Fiber Optic and Power Cables, 50 ft (15.25 m)
Fluid Station Control Box
Discrete I/O Board
A Side Dump Valve, if color valve(s) selected
Flow Control with 15 ft (4.57 m) Cable (if selected)
Basic Web Interface





Accessories





Accessory
15V536 Solvent Flow Switch Kit
15V213 Power Cable, 100 ft (30.5 m)
15G710 Fiber Optic Cable, 100 ft (30.5 m)
15G614 Flow Control Extension Cable, 40 ft (12.2 m)
15W034 Strobe Light Alarm Indicator Kit
15V331 Gateway Ethernet Communication Kit
15V963 Gateway DeviceNet Communication Kit
15V964 Gateway Profibus Communication Kit
15V337 Advanced Web Interface

NOTE: This is not a complete list of available accessories and kits. Refer to the Graco website for more information about accessories available for use with this product.

Warnings





The following warnings are for the setup, use, grounding, maintenance, and repair of this equipment. The exclamation point symbol alerts you to a general warning and the hazard symbols refer to procedure-specific risks. When these symbols appear in the body of this manual, refer back to these Warnings. Product-specific hazard symbols and warnings not covered in this section may appear throughout the body of this manual where applicable.

 WARNING	
	<p>FIRE AND EXPLOSION HAZARD</p> <p>Flammable fumes, such as solvent and paint fumes, in work area can ignite or explode. To help prevent fire and explosion:</p> <ul style="list-style-type: none"> • Use equipment only in well ventilated area. • Eliminate all ignition sources; such as pilot lights, cigarettes, portable electric lamps, and plastic drop cloths (potential static arc). • Keep work area free of debris, including solvent, rags and gasoline. • Do not plug or unplug power cords, or turn power or light switches on or off when flammable fumes are present. • Ground all equipment in the work area. See Grounding instructions in your system installation manual. • Use only grounded hoses. • Hold gun firmly to side of grounded pail when triggering into pail. • If there is static sparking or you feel a shock, stop operation immediately. Do not use equipment until you identify and correct the problem. • Keep a working fire extinguisher in the work area.
	<p>ELECTRIC SHOCK HAZARD</p> <p>This equipment must be grounded. Improper grounding, setup, or usage of the system can cause electric shock.</p> <ul style="list-style-type: none"> • Turn off and disconnect power at main switch before disconnecting any cables and before servicing equipment. • Connect only to grounded power source. • All electrical wiring must be done by a qualified electrician and comply with all local codes and regulations.
	<p>INTRINSIC SAFETY</p> <p>Intrinsically safe equipment that is installed improperly or connected to non-intrinsically safe equipment will create a hazardous condition and can cause fire, explosion, or electric shock. Follow local regulations and the following safety requirements.</p> <ul style="list-style-type: none"> • Only models with a G3000, G250, G3000HR, G250HR, or intrinsically safe Coriolis meter are approved for installation in a Hazardous Location - Class I, Div I, Group D, T3 or Zone I Group IIA T3. • Do not install equipment approved only for a non-hazardous location in a hazardous area. See the ID label for the intrinsic safety rating of your model. • Do not substitute or modify system components as this may impair intrinsic safety.

 WARNING	
	<p>SKIN INJECTION HAZARD</p> <p>High-pressure fluid from gun, hose leaks, or ruptured components will pierce skin. This may look like just a cut, but it is a serious injury that can result in amputation. Get immediate surgical treatment.</p> <ul style="list-style-type: none"> • Tighten all fluid connections before operating the equipment. • Do not point gun at anyone or at any part of the body. • Do not put your hand over the spray tip. • Do not stop or deflect leaks with your hand, body, glove, or rag. • Follow Pressure Relief Procedure in this manual, when you stop spraying and before cleaning, checking, or servicing equipment.
	<p>EQUIPMENT MISUSE HAZARD</p> <p>Misuse can cause death or serious injury.</p> <ul style="list-style-type: none"> • Do not operate the unit when fatigued or under the influence of drugs or alcohol. • Do not exceed the maximum working pressure or temperature rating of the lowest rated system component. See Technical Data in all equipment manuals. • Use fluids and solvents that are compatible with equipment wetted parts. See Technical Data in all equipment manuals. Read fluid and solvent manufacturer's warnings. For complete information about your material, request MSDS forms from distributor or retailer. • Check equipment daily. Repair or replace worn or damaged parts immediately with genuine manufacturer's replacement parts only. • Do not alter or modify equipment. • Use equipment only for its intended purpose. Call your distributor for information. • Route hoses and cables away from traffic areas, sharp edges, moving parts, and hot surfaces. • Do not kink or over bend hoses or use hoses to pull equipment. • Keep children and animals away from work area. • Comply with all applicable safety regulations.
	<p>TOXIC FLUID OR FUMES HAZARD</p> <p>Toxic fluids or fumes can cause serious injury or death if splashed in the eyes or on skin, inhaled, or swallowed.</p> <ul style="list-style-type: none"> • Read MSDS's to know the specific hazards of the fluids you are using. • Store hazardous fluid in approved containers, and dispose of it according to applicable guidelines. • Always wear chemically impermeable gloves when spraying or cleaning equipment.
	<p>PERSONAL PROTECTIVE EQUIPMENT</p> <p>You must wear appropriate protective equipment when operating, servicing, or when in the operating area of the equipment to help protect you from serious injury, including eye injury, inhalation of toxic fumes, burns, and hearing loss. This equipment includes but is not limited to:</p> <ul style="list-style-type: none"> • Protective eyewear • Clothing and respirator as recommended by the fluid and solvent manufacturer • Gloves • Hearing protection

Important Two-Component Material Information

Isocyanate Conditions

						
--	---	---	---	---	--	--



Spraying or dispensing materials containing isocyanates creates potentially harmful mists, vapors, and atomized particulates.

Read material manufacturer's warnings and material MSDS to know specific hazards and precautions related to isocyanates.

Prevent inhalation of isocyanate mists, vapors, and atomized particulates by providing sufficient ventilation in the work area. If sufficient ventilation is not available, a supplied-air respirator is required for everyone in the work area.



To prevent contact with isocyanates, appropriate personal protective equipment, including chemically impermeable gloves, boots, aprons, and goggles, is also required for everyone in the work area.

Material Self-ignition

						
--	---	--	--	--	--	--

Some materials may become self-igniting if applied too thickly. Read material manufacturer's warnings and material MSDS.

Keep Components A and B Separate

						
--	---	---	--	--	--	--

Cross-contamination can result in cured material in fluid lines which could cause serious injury or damage equipment. To prevent cross-contamination of the equipment's wetted parts, **never** interchange component A (isocyanate) and component B (resin) parts.

Moisture Sensitivity of Isocyanates

Isocyanates (ISO) are catalysts used in two component coatings. ISO will react with moisture (such as humidity) to form small, hard, abrasive crystals, which become suspended in the fluid. Eventually a film will form on the surface and the ISO will begin to gel, increasing in viscosity. If used, this partially cured ISO will reduce performance and the life of all wetted parts.

NOTE: The amount of film formation and rate of crystallization varies depending on the blend of ISO, the humidity, and the temperature.

To prevent exposing ISO to moisture:

- Always use a sealed container with a desiccant dryer in the vent, or a nitrogen atmosphere. **Never** store ISO in an open container.
- Use moisture-proof hoses specifically designed for ISO, such as those supplied with your system.
- Never use reclaimed solvents, which may contain moisture. Always keep solvent containers closed when not in use.
- Never use solvent on one side if it has been contaminated from the other side.
- Always lubricate threaded parts with ISO pump oil or grease when reassembling.

Changing Materials

- When changing materials, flush the equipment multiple times to ensure it is thoroughly clean.
- Always clean the fluid inlet strainers after flushing.
- Check with your material manufacturer for chemical compatibility.

Glossary of Terms

Advanced Web Interface (AWI) - This allows remote ProMix backup and restore, configuration, logging, and software update options.

Air Chop - the process of mixing air and solvent together during the flush cycle to help clean the lines and reduce solvent usage.

Air Chop Time- duration of each activation of the air purge valve during a chop sequence. User settable from 0.0-99.9 seconds.

Analog - relating to, or being a device in which data are represented by continuously variable, measurable, physical quantities, such as length, width, voltage, or pressure.

B Purge After Chop - Optional 2-second B solvent valve activation after the Chop sequence. This is used to separate the chop material and the Final Purge material to prevent unwanted mixing.

Basic Web Interface (BWI) - This allows remote ProMix backup and restore, logging, and software update options.

Bootloader - The utility program that handles initial system startup re-programming of the main ProMix application.

Chop Time- refers to the total length of the chop sequence during a purge. User settable from 0-999 seconds.

Closed Loop Flow Control - refers to the process when the flow rate is adjusted automatically to maintain a constant flow.

Color/Catalyst Purge - refers to the time required to flush the lines from the color or catalyst change module to the mix manifold during a color or catalyst change.

Color/Catalyst Fill - refers to the time required to fill the lines from the color or catalyst change module to the mix manifold.

Command Holdoff - The amount of time that flow rate learning is not allowed after the set point is changed to allow the flow rate to stabilize.

Coriolis Meter - a non-intrusive flow meter often used in low flow applications or with light viscosity, shear sensitive, or acid catalyzed materials. This meter uses vibration to measure flow.

Custom Language - A method to load a translation file into the ProMix to display languages other than those built into the system. Only Unicode characters through codespace 0x00FF are supported.

Digital Input and Output - a description of data which is transmitted as a sequence of discrete symbols, most commonly this means binary data represented using electronic or electromagnetic signals.

Discrete I/O - refers to data that constitutes a separate entity and has direct communication to another control.

Dose Size - the amount of resin (A) and catalyst (B) that is dispensed into an integrator.

Dose Time Alarm - the amount of time that is allowed for a dose to occur before an alarm occurs. More than 30 pulses from the flow meter of the active dose valve are needed while the Gun Trigger is on to prevent the alarm.

Dynamic Dosing - Component A dispenses constantly. Component B dispenses intermittently in the necessary volume to attain the mix ratio.

Ethernet - a method for directly connecting a computer to a network or equipment in the same physical location.

ExtSP - External Set Point selection for PLC input of the flow rate set point while operating in Flow Control Override mode.

Fiber Optic Communication - the use of light to transmit communication signals. Blue is the transmitter, and black is the receiver. This must be cross-connected between the EasyKey and the Fluid Panel for communication to work. The Fiber Optic cable has a blue band to indicate the proper connection.

Final Purge Source- source of the media used in the final purge cycle. User settable to air purge valve, solvent purge valve, or 3rd purge valve.

Final Purge Time- duration of the final purge cycle. User settable from 0-999 seconds.

First Purge Source- source of the media used in the first purge cycle. User settable to air purge valve, solvent purge valve, or 3rd purge valve

First Purge Time- duration of the first purge cycle. User settable from 0-999 seconds.

Flow Control Resolution - a settable value that allows the flow control system to maximize its performance. The value is based on maximum desired flow rates.

Flow Rate Analog Signal - the type of communication signal that can be used on the ProControl module.

Flow Rate Tolerance - the settable percent of acceptable variance that the system will allow before a flow rate warning occurs.

Flow Set Point - a predefined flow rate target.

Flush Volume Check - system monitors flush volume. E-11 Alarm occurs if minimum volume is not achieved. Minimum flush volume is user settable (0-999 cc).

Global - indicates that values on the screen apply to all recipes, 1 through 60.

Grand Total - a non-resettable value that shows the total amount of material dispensed through the system.

GT-Off Drive Time - The amount of time to regulate the fluid pressure based on the flow rate set point after the gun trigger is closed.

GT-Off Target Rise - The additional time to regulate the fluid pressure based on the flow rate set point after the gun trigger is closed.

Gun Trigger Holdoff - The amount of time that flow rate learning is not allowed after the gun trigger is opened to allow the flow rate to stabilize.

Gun Trigger Input Signal - used to manage ratio assurance dose times and flow control processes.

Intrinsically Safe (IS) - refers to the ability to locate certain components in a hazardous location.

Idle - if the gun is not triggered for 2 minutes the system enters Idle mode. Trigger the gun to resume operation.

Job Total - a resettable value that shows the amount of material dispensed through the system for one job. A job is complete when a color change or complete system flush occurs.

K-factor - a value that refers to the amount of material that passes through a meter. The assigned value refers to an amount of material per pulse.

Kd - refers to the amount the fluid flow system attempts to not overshoot the target set point.

Ki - refers to the degree fluid flow over shoots its set point.

Kp - refers to the speed in which the fluid flow reaches its set point.

Learn Strength - How much and how quickly to apply the difference in the flow rate set point compared to the measured flow rate when updating the flow control data table.

Manual Mode - when the proportioning or flow control system is controlling the inputs without any input from an outside control.

Minimum Material Fill Volume - system monitors material fill volume. E-21 Alarm occurs if minimum volume is not achieved. Minimum material fill volume is user settable (0-9999 cc).

Mix - when cross-linking of the resin (A) and catalyst (B) occurs.

Mix Fill Push - An option for the Autodump selection to automatically clear the Potlife alarm if the gun is in the Gun Flush Box by running new mixed material through the gun.

Mix Input Signal- refers to system mode status where system begins a dose sequence each time the mix signal is made "High".

Mixed Material Fill Time - the amount of time that is required to load mixed material from the dose valves to the applicator/gun.

Modbus/TCP - a type of communication protocol used to communicate Digital I/O signals over an ethernet.

Network Station - a means to identify a particular individual proportioning or flow control system.

One-Point Learning - Flow Control table calibration method using learned points above a specified flow rate to interpolate the table at low flow rates with short gun trigger times.

Overdose (A, B, C) Alarm - when either the resin (A), or catalyst (B), or reducer (C) component dispenses too much material and the system cannot compensate for the additional material.

Potlife Time - the amount of time before a material becomes unsprayable.

Potlife Volume - the amount of material that is required to move through the mix manifold, hose and applicator before the potlife timer is reset.

Purge - when all mixed material is flushed from the system.

Purge Drive - The voltage drive during the Purge sequence, maximum of 3300 mV. The response curve of the V/P regulator is not linear, so it may be necessary to test the response using Manual Override mode.

Purge Time - the amount of time required to flush all mixed material from the system.

Purge Volume Alarm - E-11 Alarm occurs if minimum flush volume is not achieved.

Ratio Tolerance - the settable percent of acceptable variance that the system will allow before a ratio alarm occurs.

Sequential Color Change - the process when a color change is initiated and the system automatically flushes the old color and loads a new color.

Sequential Dosing - Components A and B dispense sequentially in the necessary volumes to attain the mix ratio.

Solvent/3rd Purge Valve Chop Time- duration of each activation of the solvent or 3rd purge valve during a chop sequence. User settable from 0.0-99.9 seconds.

Solvent Fill - the time required to fill the mixed material line with solvent.

Solvent Push - enables the user to save some mixed material by pushing it out to the gun with solvent. Requires an accessory solvent meter.

Standby - refers to the status of the system.

System Idle - This warning occurs if the ProControl is set to Mix, and 2 minutes have elapsed since the system received a flow meter pulse.

Third Purge Valve - refers to the use of three purge valves used to flush some waterborne materials. The valves are used to flush with water, air and solvent.

V/P - refers to the voltage to pressure device in the flow control module.

Valve Holdoff Maximum - The maximum amount of time that flow rate learning is not allowed after a dose valve cycles. The system may internally use a time less than is based on the stability of the fluid meter pulse stream.

Overview

Usage

The Graco ProControl 1KS is an electronic flow control and color change system, for use with most solvent and waterborne epoxy, polyurethane, and acid-catalyzed paints. It is not for use with “quick-setting” paints (those with a potlife of less than 15 minutes).

- Has user selectable ratio assurance and can maintain up to +/-1% accuracy, depending on materials and operating conditions.
- Models are available to operate air spray or air-assisted systems with a capacity of up to 3800 cc/min.
- Color change options are available for low pressure (300 psi [2.1 MPa, 21 bar]) air spray and high pressure (3000 psi [21 MPa, 210 bar]) systems with up to 30 color change valves and up to 4 catalyst change valves.

NOTE: Optional accessories are available for in field installation to achieve 30 colors.

Component Identification and Definition

See Table 1, and FIG. 2 for the wall mount system components.

Table 1: Component Descriptions

Component	Description
EasyKey (EK)	Used to set up, display, operate, and monitor the system. The EasyKey accepts 85-250 VAC, 50/60 Hz line power and converts that power to acceptable low voltage and optical signals used by other system components.
Fluid Station Control Box (ST)	Includes air control solenoids. Its control board manages all fluid functions.
Fluid Manifold (FM)	Includes wall mounting bracket and mountings for the fluid meter and the following valves: <ul style="list-style-type: none"> • Pneumatically Operated Dose Valve for component A • Purge Valves for solvent and air purge
Flow Meters (MA, MS)	Four optional flow meters are available from Graco: <ul style="list-style-type: none"> • G3000 is a general purpose gear meter typically used in flow ranges of 75-3800 cc/min. (0.02–1.0 gal/min.), pressures up to 4000 psi (28 MPa, 276 bar), and viscosities of 20–3000 centipoise. The K-factor is approximately 0.119 cc/pulse. • G3000HR is a high resolution version of the G3000 meter. It is typically used in flow ranges of 38–1900 cc/min. (0.01–0.5 gal/min.), pressures up to 4000 psi (28 MPa, 276 bar). and viscosities of 20–3000 centipoise. The K-factor is approximately 0.061 cc/pulse. • S3000 is a gear meter used for solvents in flow ranges of 38-1900 cc/min. (0.01–0.50 gal/min.), pressures up to 3000 psi (21 MPa, 210 bar), and viscosities of 20–50 centipoise. The K-factor is approximately 0.021 cc/pulse. • Coriolis is a specialty meter capable of a wide range of flow rates and viscosities. This meter is available with 1/8 in. or 3/8 in. diameter fluid passages. For detailed information on the Coriolis meter, see manual 313599. The K-factor is user-settable; at lower flow rates use a lower K-factor. <ul style="list-style-type: none"> → 1/8 in. fluid passages: set K-factor to .020 or .061. → 3/8 in. fluid passages: set K-factor to .061 or 0.119.

Table 1: Component Descriptions (Continued)

Component	Description
Color Change Valves (ACV) and Color Change Module (CCM)	An optional component. It is available as a color change valve stack for either low or high pressure with up to 30 color change valves. Each stack includes one additional valve for solvent to clean the fluid line between color changes.
Dual Fiber Optic Cable (FO)	Used to communicate between the EasyKey and Fluid Station Control Box.
Fluid Station Control Box Power Supply Cable (PS)	Used to provide power to the Fluid Station Control Box.
Flow Control Regulator Assembly (FC)	Includes an air operated fluid pressure regulator, fluid pressure sensor, voltage to air pressure transducer and circuit board. The function of this unit is to receive the flow analog signal and drive (manage) the desired flow rate.
EasyKey (EK)	Used to set up, display, operate, and monitor the system. The EasyKey accepts 85-250 VAC, 50/60 Hz line power and converts that power to acceptable low voltage and optical signals used by other system components.
Fluid Station Control Box (ST)	Includes air control solenoids. Its control board manages all fluid functions.

Wall Mount System Components

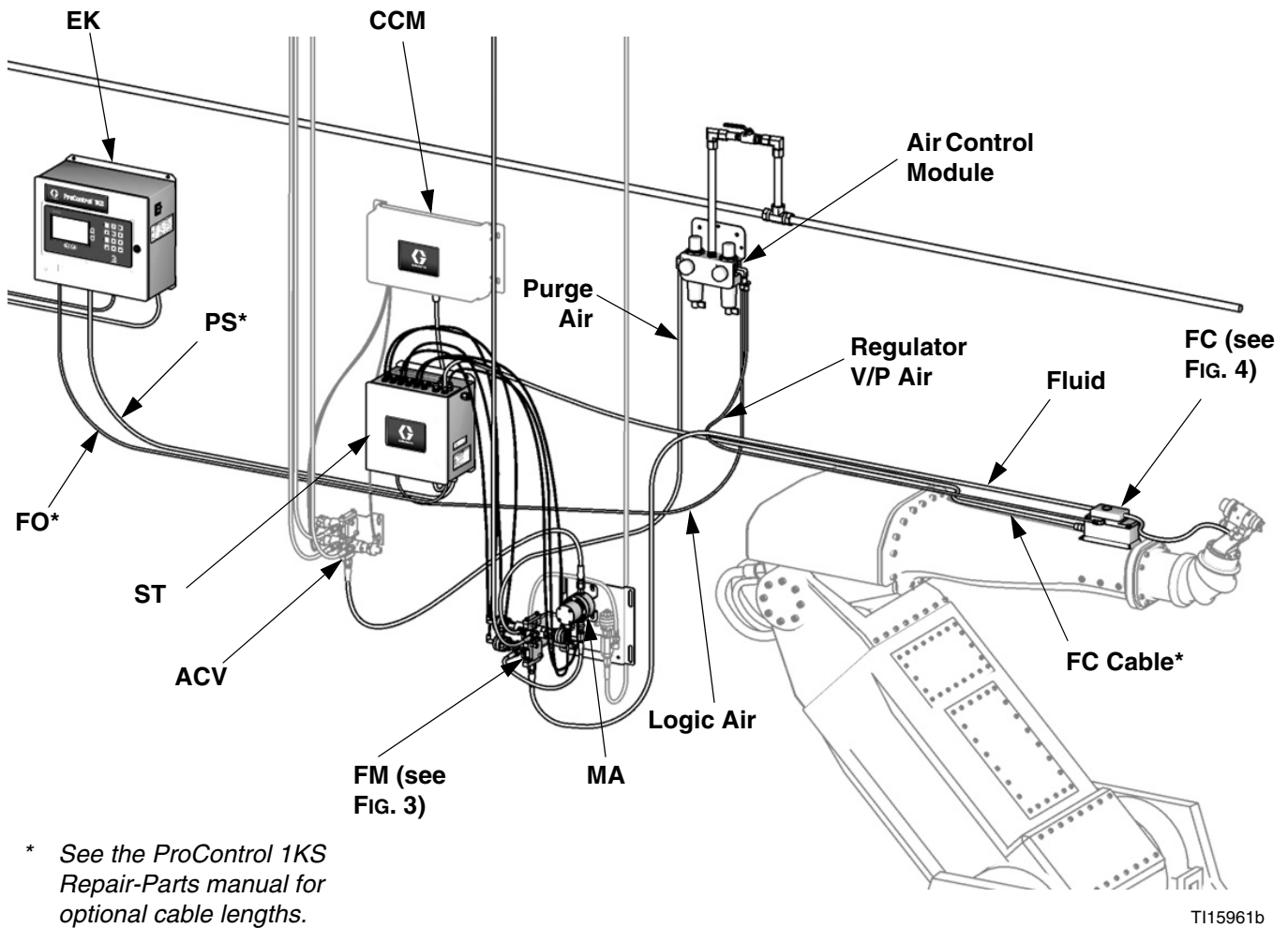
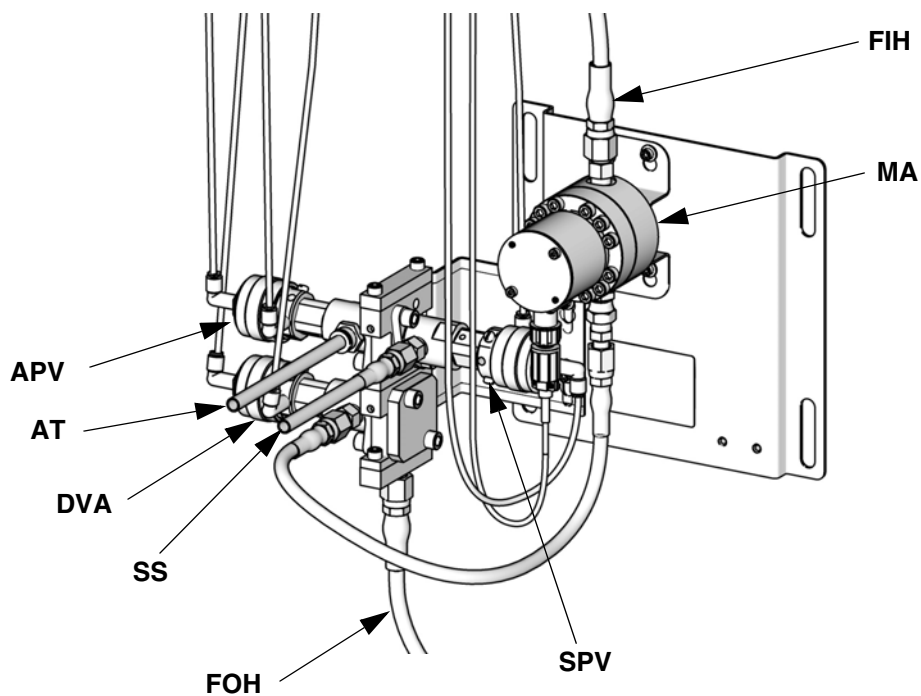

FIG. 2. ProControl 1KS System, shown with G3000 Meter, Color Change, and Flow Control



T115977a

FIG. 3. Fluid Manifold

Key:

- | | | | |
|-----|---|-----|---------------------------------|
| MA | Component A Meter | APV | Air Purge Valve |
| DVA | Component A Dose Valve | AT | Air Purge Valve Air Supply Tube |
| SPV | Solvent Purge Valve | FIH | Fluid Inlet Hose |
| SS | Solvent Purge Valve Solvent Supply Tube | FOH | Fluid Outlet Hose |

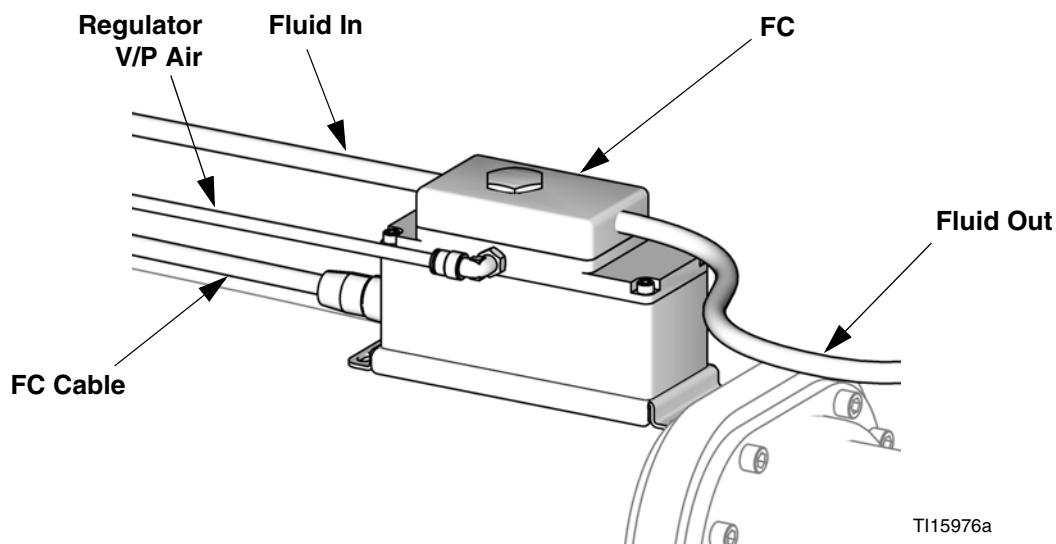

T115976a

FIG. 4. Flow Control Regulator

EasyKey Display and Keypad

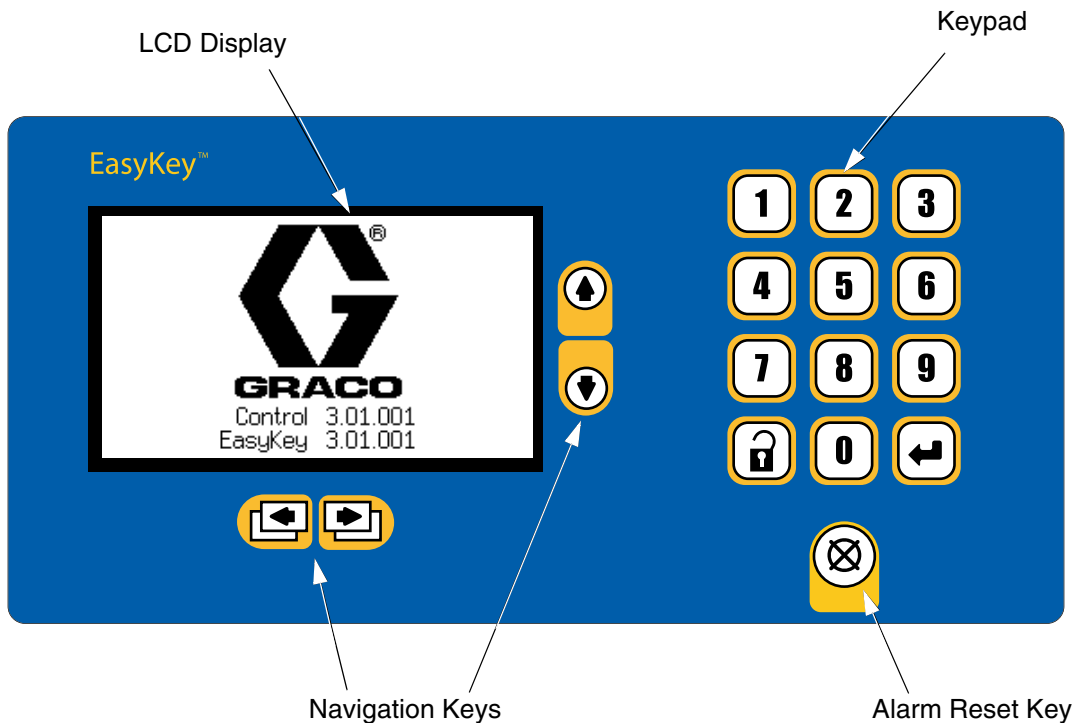

TI11630A

FIG. 5. EasyKey Display and Keypad

Display

Shows graphical and text information related to setup and spray operations. Back light will turn off after 10 minutes without any key press. Press any key to turn back on.

NOTE: Pressing a key to turn on the display back light will also perform the function of that key. If you are unsure whether that key will impact your current operation, use the setup or navigation keys to turn on the display back light.

Keypad

Used to input numerical data, enter setup screens, scroll through screens, and select setup values.

In addition to the numbered keys on the EasyKey keypad, which are used to enter values in setup, there are keys to navigate within a screen and between screens, and to save entered values. See Table 2.

Table 2: EasyKey Keypad Functions (see FIG. 5)

Key	Function
	<i>Setup:</i> press to enter or exit Setup mode.
	<i>Enter:</i> if cursor is in menu box, press Enter key to view menu. Press Enter to save a value either keyed in from the numerical keypad or selected from a menu.
	<i>Up Arrow:</i> move to previous field or menu item, or to previous screen within a group.
	<i>Down Arrow:</i> move to next field or menu item, or to next screen within a group.
	<i>Left Arrow:</i> move to previous screen group.
	<i>Right Arrow:</i> move to next screen group.
	<i>Alarm Reset:</i> resets alarms. If the display becomes unresponsive, pressing this key 4 times in succession will re-initialize the display.

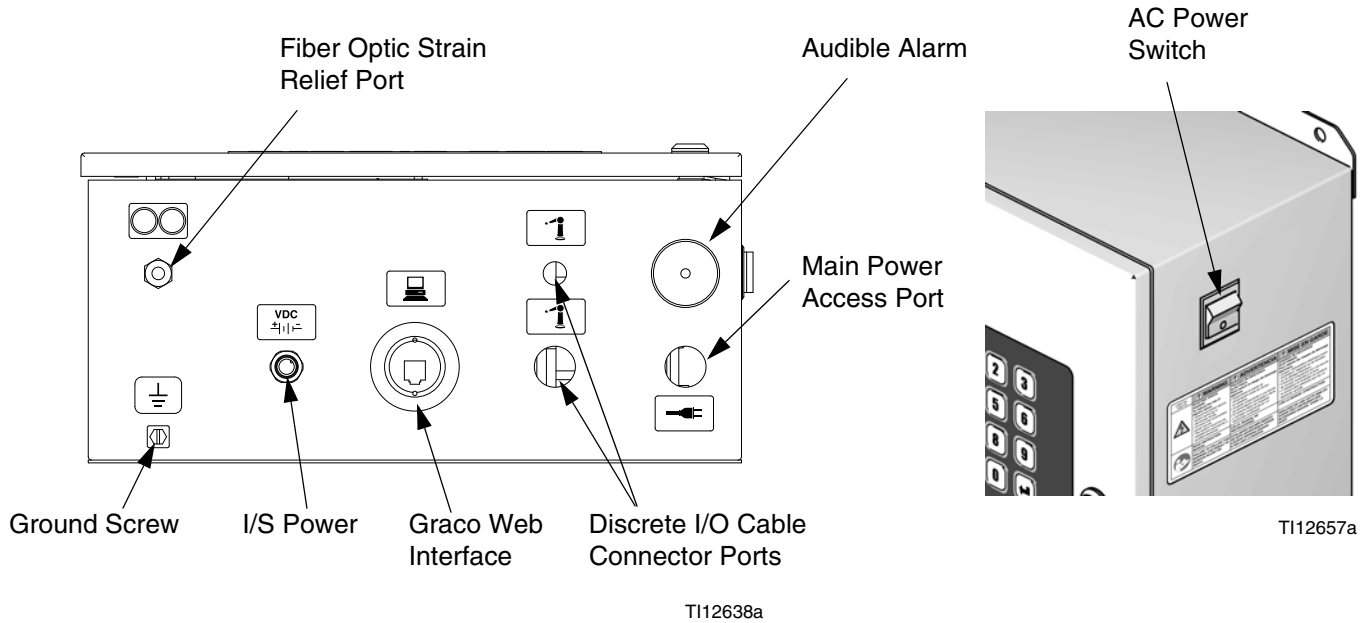

FIG. 6. EasyKey Connections and AC Power Switch

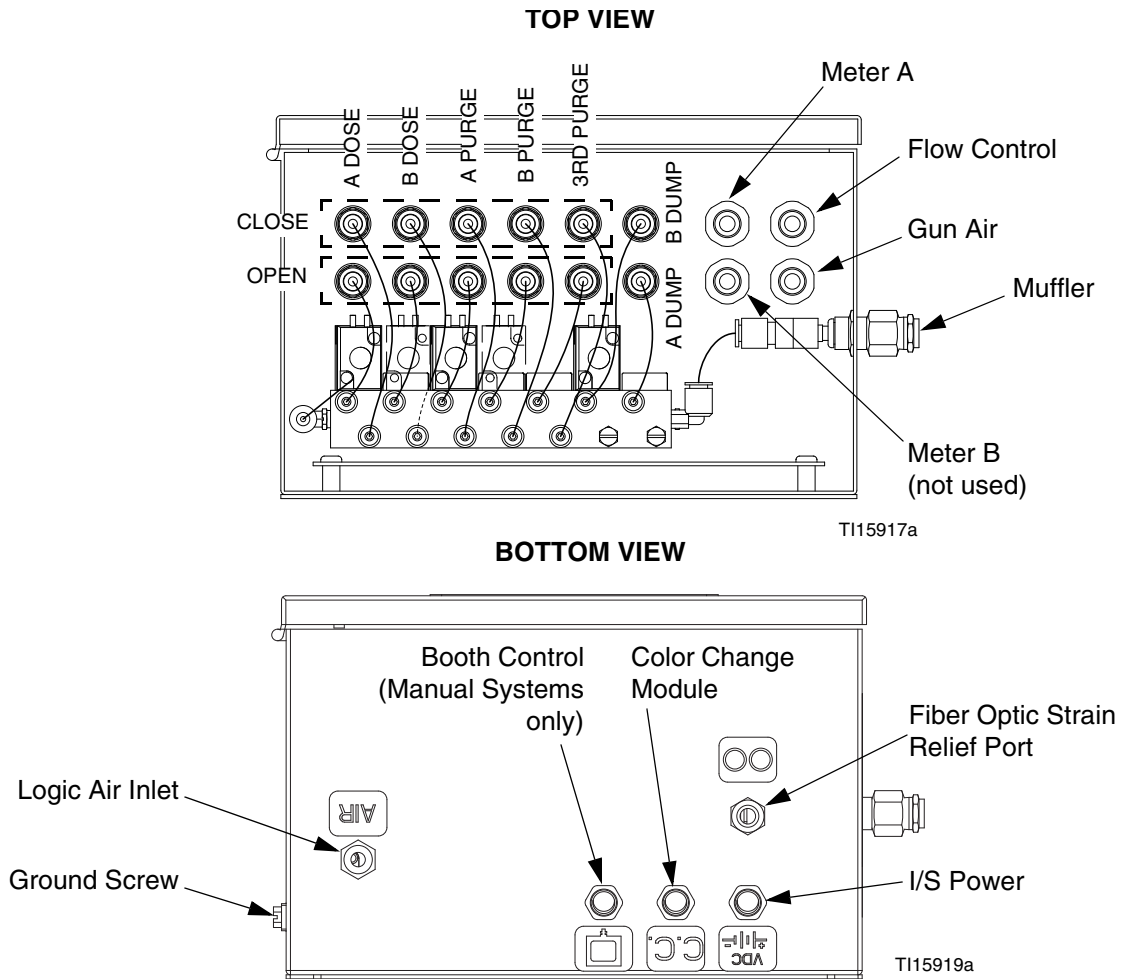

FIG. 7. Fluid Station Control Box Connections

AC Power Switch

Turns system AC power on or off.

I/S Power

Power circuit to Fluid Station.

Audible Alarm

Alerts the user when an alarm occurs. Available settings for selecting which alarms will cause an audible alarm are explained in **Configure Screen 1**, page 29.

Clear the audible alarm by pressing the Alarm Reset



Even after the Alarm Reset key is pressed, the Potlife Exceeded alarm message will remain displayed until a sufficient amount of mixed material has been dispensed to ensure that the expired material has been ejected.

Graco Web Interface Port

Used to communicate with the ProControl from a PC to:

- Upgrade software
- View software version
- Download
 - Job and alarm logs
 - Material usage report
 - Setup values (can also upload)
- Clear job, alarm, and material usage reports
- Upload a custom language to view on screen
- Restore factory defaults
- Restore setup password

See manual 313386 for more information.

NOTE: If using the Graco Gateway in your system, disconnect its cable from the EasyKey before updating the ProControl software.

Ethernet Connection

You can access data on an office or industrial network through the internet with the proper configuration. See manual 313386 for more information.

Run Mode Screens

NOTE: See FIG. 10 for a map of the Run screens. Detailed screen descriptions follow.

Splash Screen

At power up, the Graco logo and software revision will display for approximately 5 seconds, followed by the **Status Screen** (see page 21).



FIG. 8. Splash Screen

The Splash screen will also momentarily display “Establishing Communication.” If this display remains for more than one minute, check that the fluid station circuit board is powered up (LED is on) and that the fiber optic cable is properly connected (see Installation manual).

NOTE: If the software version of the fluid plate does not match the version of the EasyKey, the EasyKey will update the fluid plate, and the fluid plate programming screen will appear until the update is completed.

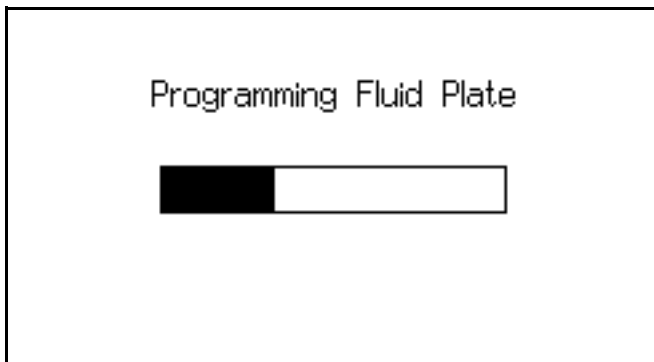
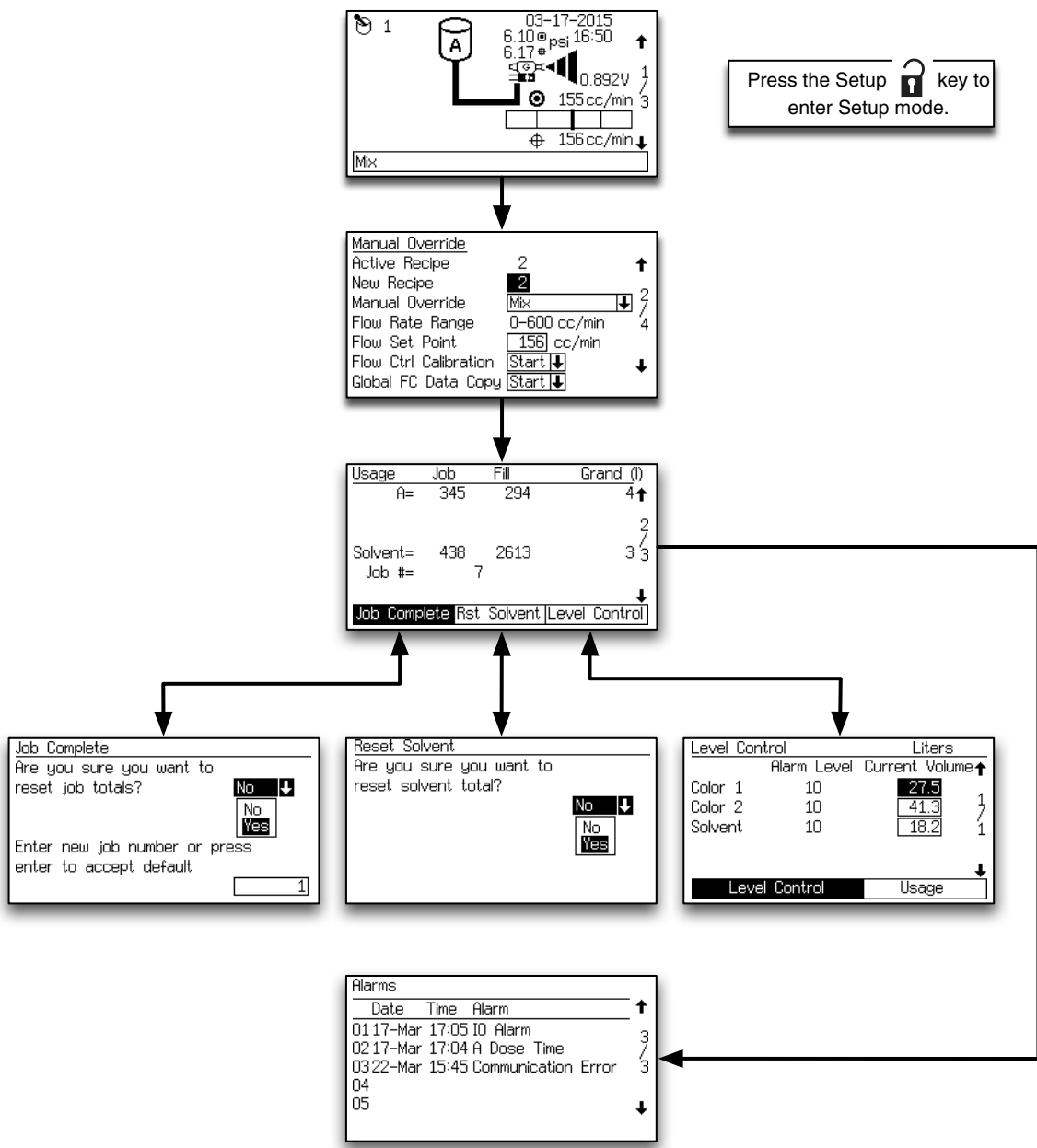





FIG. 9. Fluid Plate Programming Screen



TI12802a

FIG. 10. Run Screens Map

Status Screen

- Use the Up  or Down  keys to scroll through the Run screens.
- Press the Setup  key to enter the Setup screens from the Status screen.
- The other keys have no function in this Status screen.

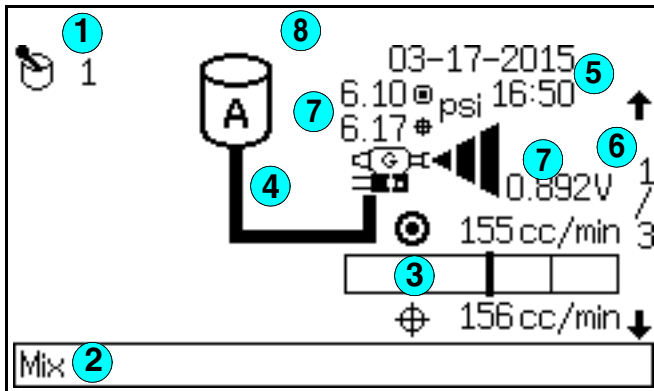

FIG. 11. Status Screen

Key to FIG. 11:

- ① **Active Recipe:** shows the active recipe.
NOTE: At power up the system defaults to Recipe 61, which is not a valid recipe number.
- ② **Status Bar:** shows current alarm or operation mode (standby, mix, purge, recipe change, or the current alarm).
NOTE: If the auto key board is removed from the EasyKey display board, the Status Bar will read "Auto key not found." This indicates that the automatic mode is not operable.
- ③ **Target Flow Rate and Current Flow Rate:** in cc/min.
- ④ **Animation:** when the gun is triggered, the gun appears to spray and the component A or B hose lights up, showing which component dose valve is open.

- ⑤ **Current Date and Time**
- ⑥ **Screen Number and Scroll Arrows:** displays the current screen number and the total number of screens in a group. The Up and Down arrows on the right edge of the screen indicate the scroll feature. The total number of screens in some groups may vary depending on system configuration selections.
- ⑦ **Current Flow Control Data:** fluid output pressure and voltage of analog signal used for driving the fluid regulator V/P.

The fluid target pressure is shown if Flow Control in **Configure Screen 5** on page 30 is set to "On: Setup".

- ⑧ **Lock Symbol:** indicates that Setup screens are password protected. See page 26.

Manual Override Screen

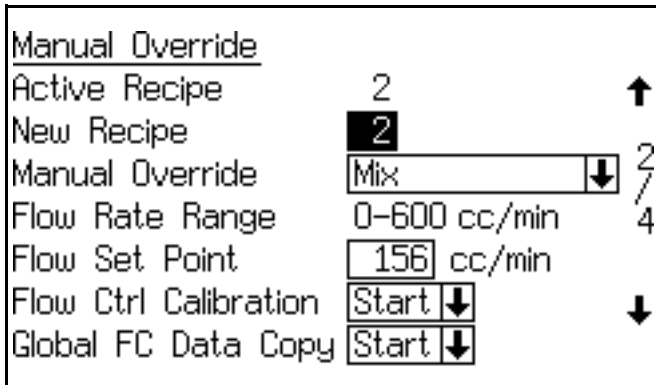



FIG. 12. Manual Override Screen

This screen will appear if Manual Override is set to "On" in **Advanced Setup Screen 1** (page 35). It shows the active recipe, new/go to recipe, and manual override mode.

If Flow Control is set to "On" in **Configure Screen 5** on page 30, this screen will also display Flow Rate Range, Flow Set Point, Flow Control Calibration (Start/Abort), and Global Flow Control Data Copy (Start/Abort).

Manual Override Menu

This field allows you to set the operating mode from the EasyKey. Press the Enter  key to view the menu, then select the desired operating mode (Standby, Mix, Purge, or Recipe Change). See FIG. 13.

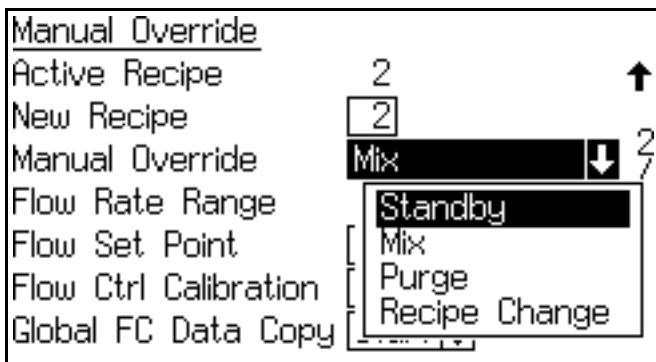

FIG. 13. Manual Override Menu

Flow Rate Range

This screen displays the flow rate range selected on **Advanced Setup Screen 5** (see page 37).

Flow Set Point

The Flow Set Point is user settable. If Flow Control Override is set to "Off" or "Pressure" in **Advanced Setup Screen 1** on page 35, the Flow Set Point will display as cc/min. Enter the desired flow set point within the range.

If Flow Control Override is set to "% Open," the Flow Set Point will display as % Open. This percentage relates to the flow control V/P ratio which translates to a fluid flow rate. Set the initial percentage at 35% and increase as necessary to reach the desired flow rate.

Flow Control Calibration

This field allows you to calibrate flow control for each recipe. The system must be in Mix mode and receiving a Gun Trigger signal. Press the Enter  key to view the menu, then select Start or Abort. See FIG. 14.

The flow rate will drop to 0, then incrementally increase until it reaches the maximum flow rate. To view the progress, go to the **Status Screen**, page 21. The system will populate the data for the current recipe. To copy this data to all recipes, see **Global Flow Control Data Copy**, page 23.

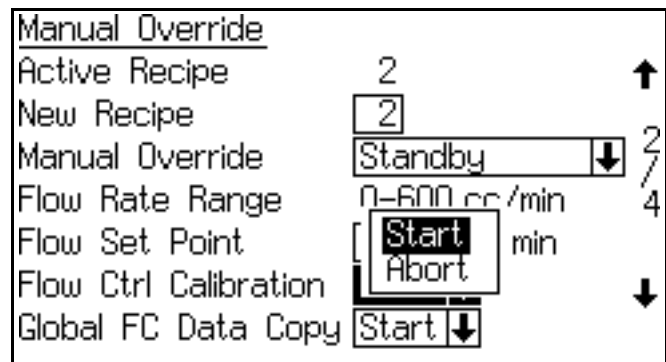



FIG. 14. Flow Control Calibration

Global Flow Control Data Copy

This field allows you to copy flow control data from the active recipe to all recipes. Press the Enter  key to view the menu, then select Start or Abort. See FIG. 15.

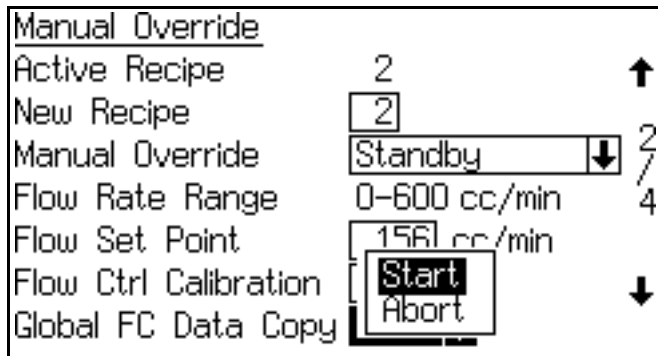

FIG. 15. Global FC Data Copy

Totals Screen

Usage	Job	Fill	Grand (l)
A=	345	294	4
Solvent=	438	2613	3
Job #=	7		

Job Complete Rst Solvent Level Control

FIG. 16. Totals Screen

This screen shows the job totals, fill totals, grand totals, and job number. Use the tabs to reset job totals (Job Complete), reset solvent totals (Rst Solvent), or go to **Level Control Screen**, page 24.

The job totals generally refer to material dispensed while in Mix mode. This is likely atomized and sprayed material with the gun trigger "On".

The fill totals generally refer to material dispensed while in Mix-fill mode after a color change or a purge operation. This is likely not sprayed or atomized, and is dispensed to a purge container.

Solvent Totals and the Rst Solvent tab only appear if "Meter" is selected under Solvent Monitor in **Configure Screen 5** on page 30.

NOTE: Grand totals are not resettable.

Reset Total Screen

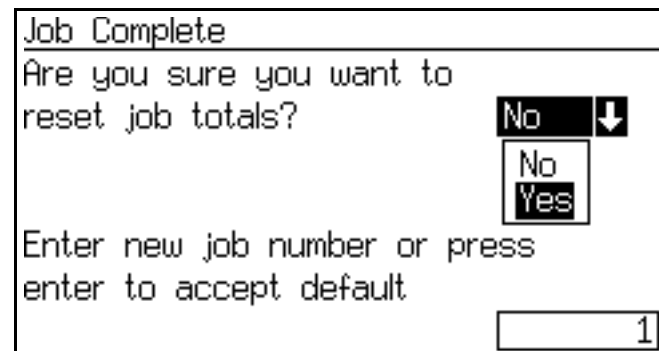

FIG. 17. Reset Total Screen

If job is reset, job number will increment by one for default.

Reset Solvent Screen

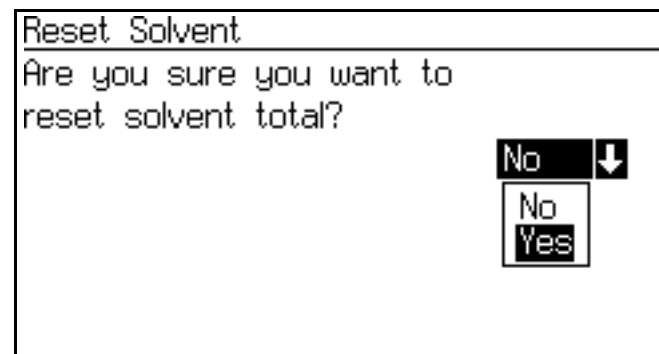

FIG. 18. Reset Solvent Total Screen

The screen will ask if you want to reset solvent total. Select Yes or No.

Alarms Screen

Alarms			
Date	Time	Alarm	↑
01 17-Mar	17:05	IO Alarm	3
02 17-Mar	17:04	A Dose Time	/
03 22-Mar	15:45	Communication Error	3
04			
05			↓

FIG. 19. Alarms Screen

Two screens show the last 10 alarms. Use the Up ↑ or Down ↓ keys to scroll between the two screens.

See Table 17 on page 118 for a list of alarm codes.

Level Control Screen

Level Control		Liters		
	Alarm Level	Current Volume		↑
Color 1	10	27.5		1
Color 2	10	41.3		/
Solvent	10	18.2		1

Level Control Usage

FIG. 20. Level Control Screen

This screen shows the current volume for each fluid. Adjust the current volumes on this screen, or use the tab to go to Usage (**Totals Screen**, page 23). The Alarm Level values may be adjusted using the advanced web interface.

See FIG. 21. If the tank volume reaches the low-level threshold, the EasyKey screen will display the Tank Level Low alarm and prompt the user to do one of the following:

1. Refill tank volume to clear the alarm.
2. Resume mixing by selecting “Spray 25% of Remainder.” If this selection is chosen, a second alarm will occur after 25% of the remaining volume is mixed. Refill tank volume to clear the alarm.

Warning: Tank Level Low Alarm	
Color 1	
	10.0 Liters Alarm Level
	10.0 Liters Current Volume
1.	Refill Tank Volume
2.	Spray 25% of Remainder
Selection	0
Tank A Low	

FIG. 21. Tank Level Low Screen (Tank A Shown)

Setup Mode

Press the Setup  key to enter Setup mode.

NOTE: See FIG. 22 for a map of the Setup screens. Detailed screen descriptions follow.

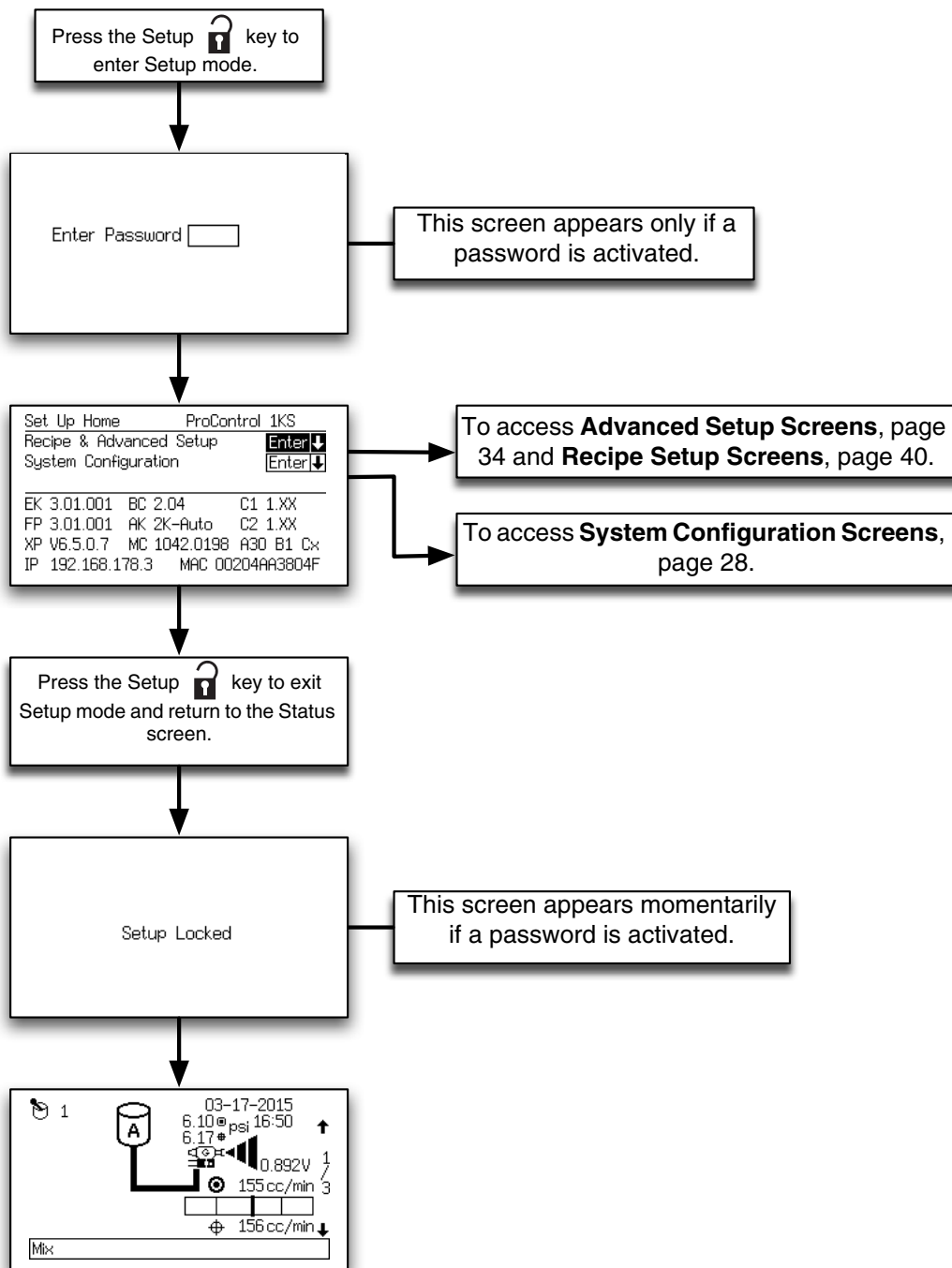

T112784a

FIG. 22. Setup Screens Map

Password Screen

If a password has been activated (see **Configure Screen 1**, page 29), the Password screen will appear. You must enter the password to access the **Set Up Home Screen**. Entering the wrong password returns the display to the **Status Screen**.

NOTE: If you forget the password, you can reset the password (to 0), using the ProControl Web Interface (see manual 313386).

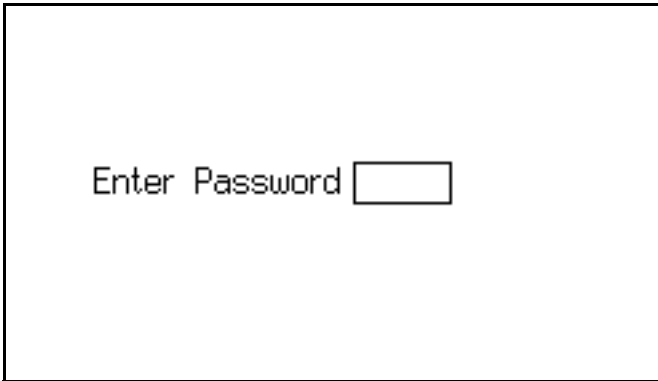

FIG. 23. Password Screen

NOTE: If a password is activated, **Setup Locked** displays momentarily after exiting Setup mode and returning to the **Status Screen**. A lock  symbol appears on the **Status Screen**.



FIG. 24. Setup Locked Screen

Set Up Home Screen

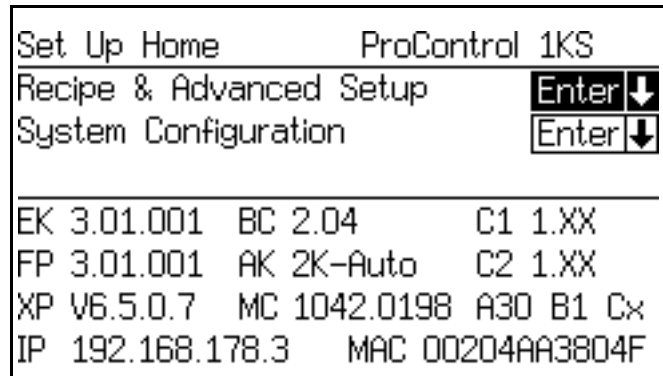



FIG. 25. Set Up Home Screen

This screen displays when you enter Setup mode. From it you can go to **Recipe and Advanced Setup Screens** (pages 34-44) or **System Configuration Screens** (pages 28-33). Press the Enter  key to go to the selected screen set.

The screen also displays software versions and internet addresses of various components. The values shown in FIG. 25 are only examples and may vary on your screen. See Table 3 for further information.

Table 3: Component Software Versions

Component	Display (may vary from examples shown)	Description	
EK (EasyKey)	3.01.001	EasyKey software version.	
FP (Fluid Plate)	3.01.001	Fluid Plate software version.	
BC (Booth Control)	.-.	Booth Control not installed, not detected, or not operational.	
	1.XX	Booth Control software version 1.00 or 1.01.	
	2.XX	Booth Control software version 2.XX.	
C1/C2 (Color Change Modules 1 and 2)	.-.	Color Change Module 1/2 not installed, not detected, or not operational.	
	1.XX	Color Change Module software version 1.00 or 1.01.	
	2.XX	Color Change Module software version 2.XX.	
AK (Autokey)	No Key	No AutoKey installed or detected. System operates in 2K Manual Mode only	
	2K-Auto	2K AutoKey detected. System can operate in 2K Manual, Semi-automatic, or Automatic Mode.	
	3K-Auto	3K AutoKey detected. System can operate in 3K Manual, Semi-automatic, or Automatic Mode.	
XP (XPORT)	V6.6.0.2	Example of XPORT network module software version. Other versions are acceptable.	
MC (Micro Controller)	1042.0198	Example of fluid plate micro controller version. Other versions are acceptable.	
Axx By Cz	A30 B4 C4	Color Change board valve configuration. This shows the number of valves available for each of the components. This is set by the configuration switches on the color change boards connected to the system.	
		Code	Description
		-	Component not available with this machine configuration.
		x	Component not used with this machine configuration.
		1	Component available but no change stack.
4-30	Component available with change stack. Number of valves flushed with a solvent valve.		
IP (Internet Address)	192.168.178.3	Example of the address EasyKey is set to for basic and advanced web interface reporting.	
MAC (MAC address)	00204AAD1810	Example of internet MAC address. Each EasyKey will have a different value in this format.	

System Configuration Screens

NOTE: See FIG. 26 for a map of the **System Configuration Screens**. Detailed screen descriptions follow.

NOTE: Each screen displays the current screen number and the total number of screens in the group.

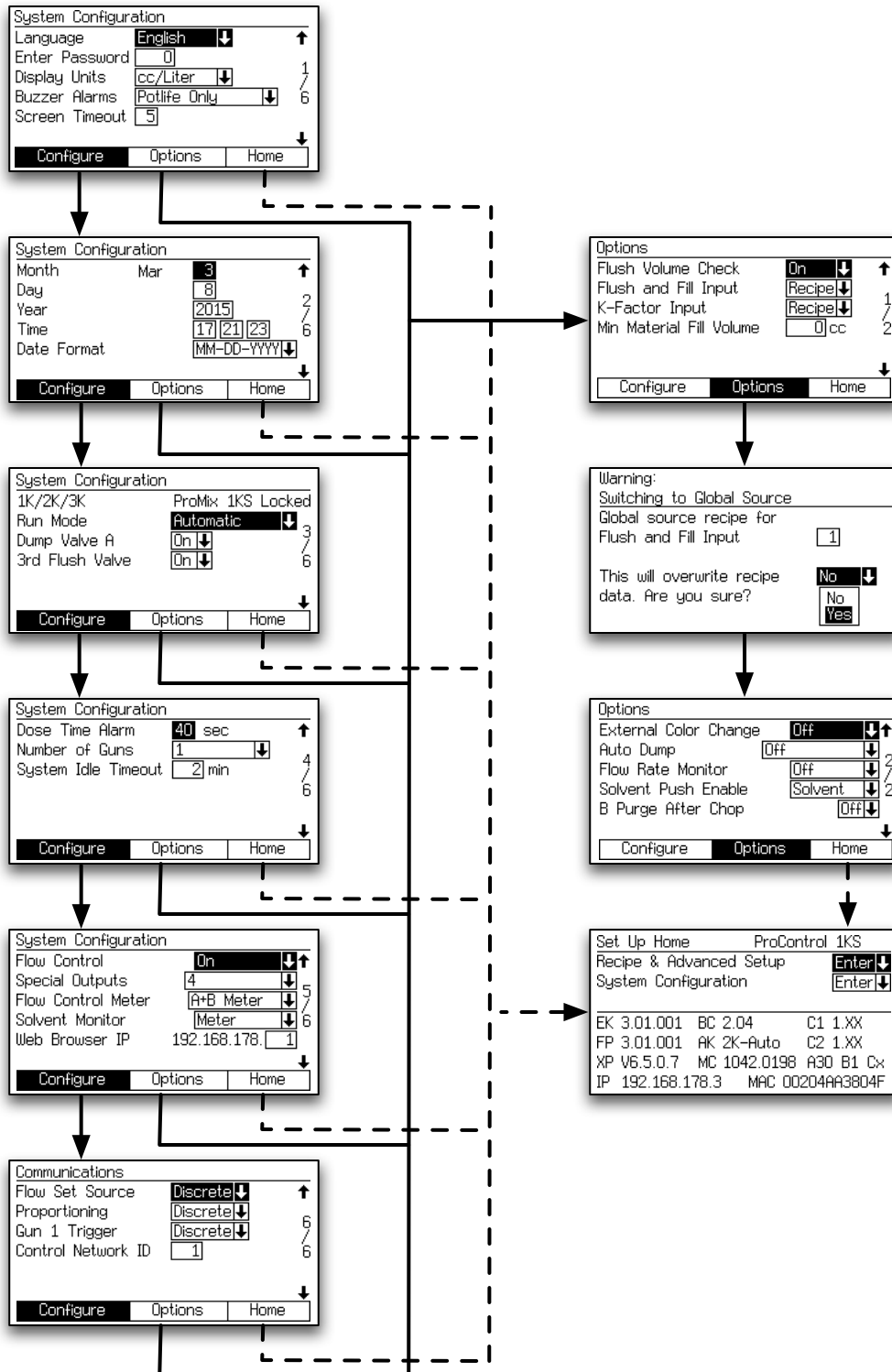

TI12804a

FIG. 26. System Configuration and Option Screens Map

Configure Screen 1

System Configuration	
Language	English ↓ ↑
Enter Password	0
Display Units	cc/Liter ↓ / 1
Buzzer Alarms	Potlife Only ↓ 6
Screen Timeout	5
↓	
Configure	Options Home

FIG. 27. Configure Screen 1

Language

Defines the language of the screen text. Select English (default), Spanish, French, German, Italian, Dutch, Japanese (Kanji), Korean, Chinese (Simplified), and Custom.

NOTE: Refer to document 313386 for instructions on using the Custom Language feature to modify the screens to support undefined languages.

Password

The password is only used to enter Setup mode. The default is 0, which means no password is required to enter Setup. If a password is desired, enter a number from 1 to 9999.

NOTE: Be sure to write down the password and keep it in a secure location.

Display Units

Select the desired display units:

- cc/liter (default)
- cc/gallon

Buzzer Alarms

As the default, the alarm buzzer is set to “Potlife Only” and will sound only for the Potlife Alarm (E-2).

Set to “All Alarms” to have the buzzer sound for any alarm.

Set to “All Except Potlife” to have the buzzer sound for any alarm except a Potlife Alarm (E2). This option is not recommended unless another active method of handling the Potlife Alarm is implemented.

Screen Timeout

Select the desired screen timeout in minutes (0-99). 5 is the default.

Configure Screen 2

System Configuration	
Month	Mar 3 ↑
Day	8 2
Year	2015 7
Time	17 21 23 6
Date Format	MM-DD-YYYY ↓
↓	
Configure	Options Home

FIG. 28. Configure Screen 2

Month

Enter current month.

Day

Enter current day.

Year

Enter current year (four digits).

Time

Enter current time in hours (24 hour clock), minutes, and seconds. Seconds are not adjustable.

Date Format

Select MM-DD-YYYY, DD-MM-YYYY, or YYYY-MM-DD.

Configure Screen 3

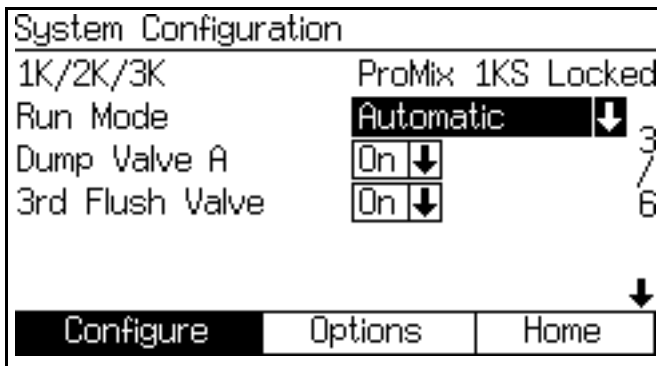

FIG. 29. Configure Screen 3

1K/2K/3K

Set this value to indicate the system performance level designation. Selecting a value other than the installed system level will result in restricted functionality.

Run Mode

NOTE: If an Autokey is installed, additional selections of Semi-Automatic and Automatic are available.

Select the Run mode application from the pulldown menu: Automatic, Semi-Automatic (uses a manual spray gun), or Manual.

Dump Valve A

This field only appears if the color change option is detected from the cc board. Select "On" if an optional Dump Valve A is installed and desired to be used.

3rd Flush Valve

Off is default. If optional 3rd flush valve is used, set to On.

Configure Screen 4

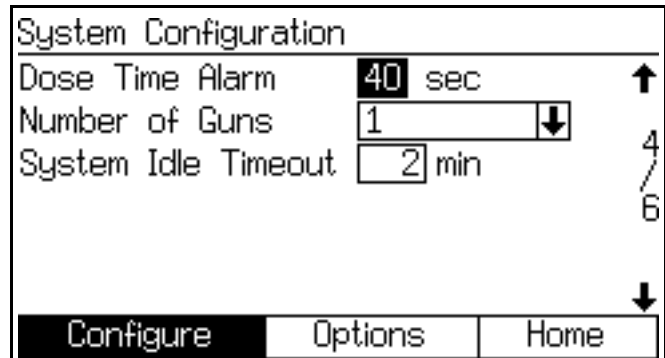

FIG. 30. Configure Screen 4

Dose Time Alarm

Enter the dose time (1 to 99 seconds). This is the amount of time allowed for a dose to occur before a dose time alarm occurs.

Configure Screen 5

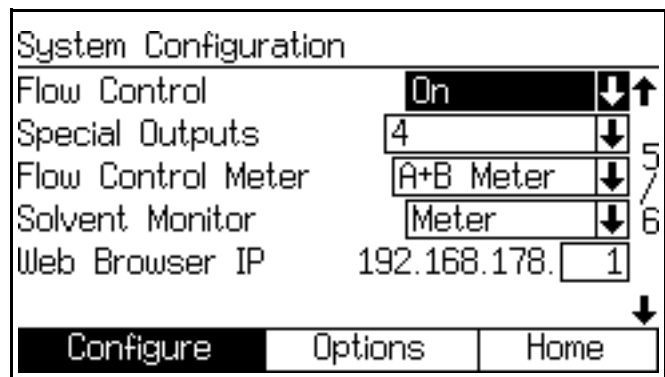

FIG. 31. Configure Screen 5

Flow Control

This field only appears if Run Mode is set to "Automatic" in **Configure Screen 3**, page 30. Select "On", "Off", or "On: Setup".

If set to "On" **Advanced Setup Screen 5**, page 37 and **Advanced Setup Screen 6**, page 38 are added.

If set to "On: Setup" **Advanced Setup Screen 5**, page 37 and **Advanced Setup Screen 6**, page 38, and **Advanced Setup Screen 7**, page 38 are added.

Special Outputs

Select special outputs (0-4, or 3 + GFB on #4). A selection of “0” will disable use of the Special Outputs. If the “3 + GFB on #4” selection is chosen, the other 3 special outputs (1-3) can be used for user-defined functions and the special output #4 settings will duplicate those settings established for the Gun Flush Box.

Each output has two different start times and durations defined on the Recipe Setup screen (Flush and Fill Input is set to “Recipe” in **Option Screen 1**, page 32), or on the Advanced Setup screen (Flush and Fill Input is set to “Global” in **Option Screen 1**, page 32).

NOTE: At system power up, the Special Outputs may activate for up to 1/4 second.

Solvent Monitor

Select solvent monitor (Off, Flow Switch, or Meter).

Web Browser IP

The default web browser IP address prefix is 192.168.178.__ Assign a unique number for each EasyKey in your system (1-99) and enter it here.

Configure Screen 6

Communications		
Flow Set Source	Discrete ↓	↑
Proportioning	Discrete ↓	6
Gun 1 Trigger	Discrete ↓	6
Control Network ID	1	6

Configure Options Home

FIG. 32. Configure Screen 6 (Automatic mode shown)

Flow Set Source

This field only appears if Run Mode is set to “Automatic” in **Configure Screen 3**, page 30 and Flow Control is set to “On” in **Configure Screen 5**, page 30. Select “Discrete” or “Network.”

Proportioning

Select “Discrete” or “Network.”

Gun 1 Trigger

Select “Discrete”, “Network”, or “AFS 1” if Run Mode is set to “Automatic” or “Semi-automatic” in **Configure Screen 3**, page 30.

Gun 2 Trigger

Displays AFS if Number of Guns is set to “2” in **Configure Screen 4**, page 30.

Control Network ID

Used for the Graco Gateway network system. See Graco Gateway manual 312785 for further information

Option Screens

NOTE: See FIG. 26 on page 28 for a map of the **Option Screens**. Detailed screen descriptions follow.

NOTE: Each screen displays the current screen number and the total number of screens in the group.

Option Screen 1

Options			
Flush Volume Check	On	↓	↑
Flush and Fill Input	Recipe	↓	1
K-Factor Input	Recipe	↓	7
Min Material Fill Volume	0	cc	2

Configure Options Home

FIG. 33. Option Screen 1

Flush Volume Check

This field only appears if Solvent Monitor is set to "Meter" in **Configure Screen 5**, page 30.

If set to "On", Minimum Flush Volume will appear in **Recipe Setup Screen 2**, page 41.

Flush and Fill Input

If set to "Global", Color/Catalyst Purge and Color/Catalyst Fill are added to **Advanced Setup Screen 1**, page 35. **Advanced Setup Screen 2 and 3** are added. See pages 36-39.

If set to "Recipe", Color/Catalyst Purge and Color/Catalyst Fill are added to **Recipe Setup Screen 2**, page 41. **Recipe Setup Screen 3, 4, and 7** are added. See pages 42-44.

K-factor Input

Global mode is useful when the material properties, flush and fill characteristics, or K-factors are the same for all materials used by the system.

If set to "Global," **Advanced Setup Screen 4**, page 37 is added.

If set to "Recipe," **Recipe Setup Screen 5**, page 43, is added.

Minimum Material Fill Volume

Enter 0-9999 cc.

Verification Screen

Warning:
Switching to Global Source

Global source recipe for
Flush and Fill Input

This will overwrite recipe
data. Are you sure?

FIG. 34. Verification Screen

Verification

This screen appears if Flush and Fill Input or K-factor Input are changed from "Recipe" to "Global" in **Option Screen 1**.

Option Screen 2

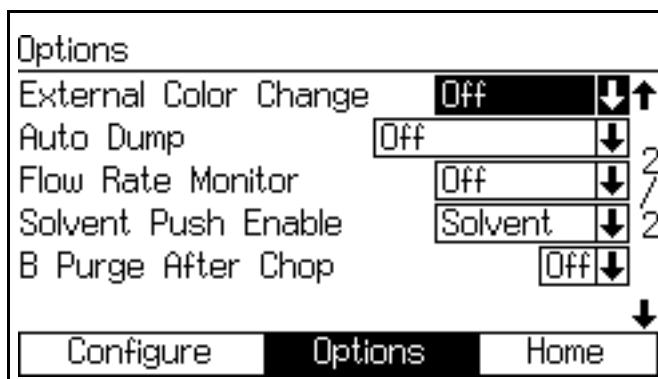

FIG. 35. Option Screen 2

External Color Change

If set to “Off”, Color/Catalyst Purge Time and Color/Catalyst Fill Time appear in **Advanced Setup Screen 1**, page 35 or **Recipe Setup Screen 2**, page 41 (depending on whether Flush and Fill Inputs are set to “Global” or “Recipe”).

If set to “On”, these fields are removed from the screens.

Auto Dump

If the auto dump feature is being used, set to “On”. Once the auto dump is enabled, the gun flush box is enabled and the potlife alarm is active for 2 minutes, the system will automatically flush out the old material.

This feature is only available in Semi-automatic mode when a Gun Flush Box is installed.

Flow Rate Monitor

This field only appears if Flow Control is set to “Off” in **Configure Screen 5**, page 30.

If set to “On,” **Recipe Setup Screen 6** on page 43 is added, enabling setting of high and low flow limits.

If set to “Off,” flow rate monitoring is disabled and **Recipe Setup Screen 6** on page 43 will not appear.

Solvent Push Enable

NOTE: See **Solvent Push Feature** on page 101 for more information.

To enable the Solvent Push feature, select “Solvent” or “3rd Valve” (available if 3rd Flush Valve in **Configure Screen 3**, page 30, is set to “On”).

To disable the Solvent Push feature, set to “Off.”

B Purge After Chop

NOTE: This is used to isolate the Chop cycle from the Final Purge cycle with solvent to prevent reaction issues with some types of materials.

Optional 2-second burst (2 s B) operation of the B Purge valve on the integrator after the Chop cycle.

See **Color Change Sequences**, page 104 for color change charts and timing information.

Advanced Setup Screens

NOTE: See FIG. 36 for a map of the **Advanced Setup Screens**. Detailed screen descriptions follow.

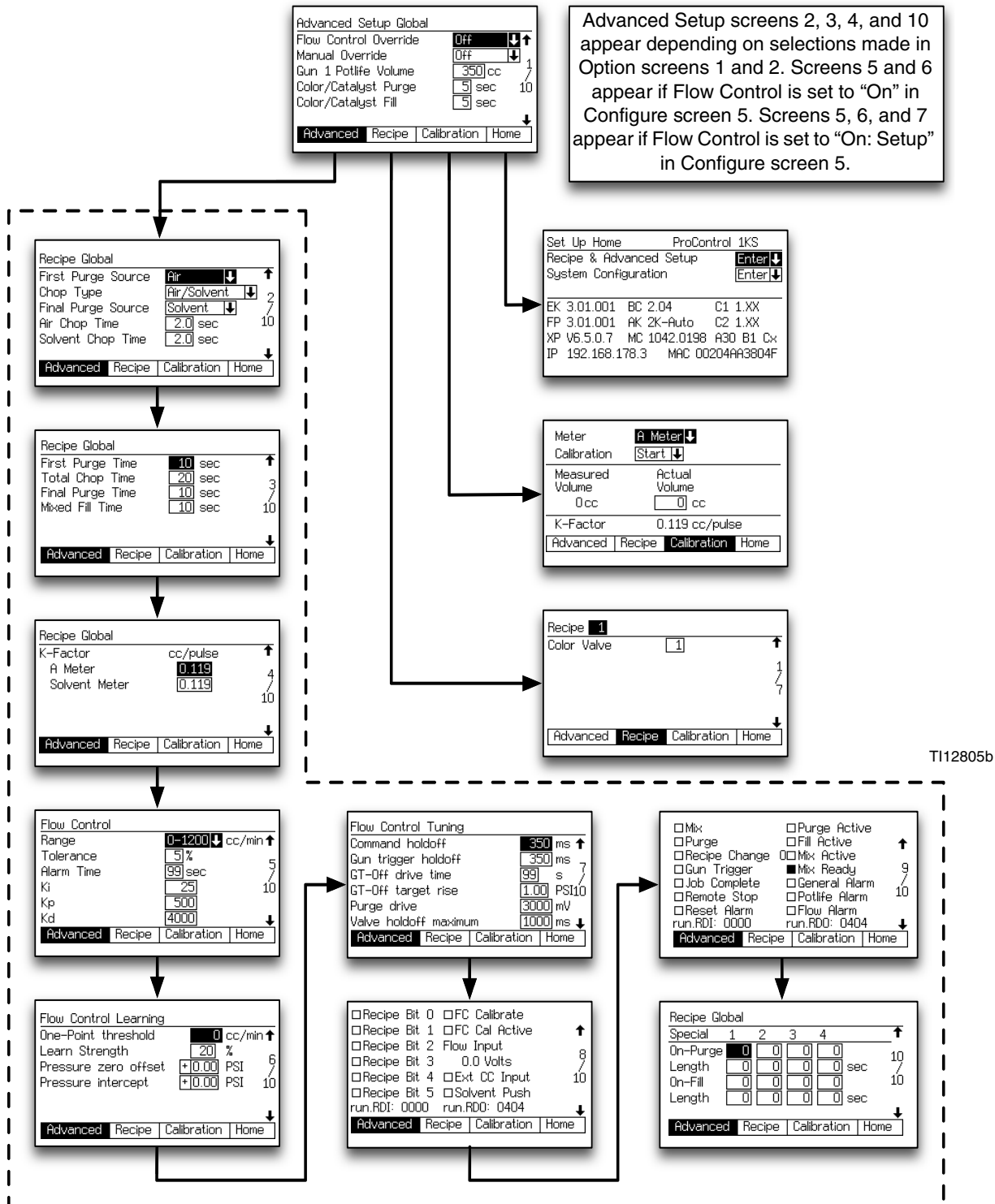

FIG. 36. Advanced Setup Screens Map

NOTE: Each screen displays the current screen number and the total number of screens in the group. The total number of screens in a group and the fields displayed on each screen may vary depending on selections made in the **System Configuration Screens** and **Option Screens**. The title at the top of the Advanced Setup screens will display “Global” when Flush and Fill on **Option Screen 1**, page 32 is set to “Global”.

Advanced Setup Screen 1

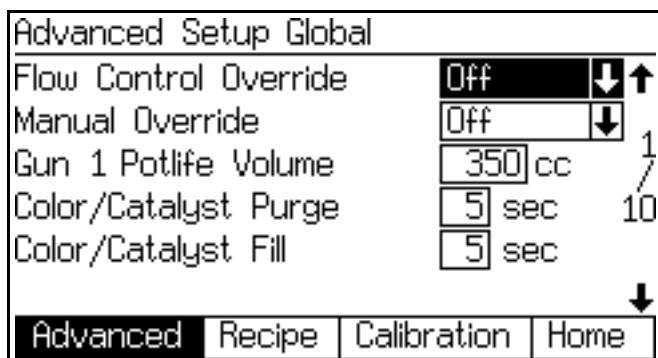

FIG. 37. Advanced Setup Screen 1

Flow Control Override

This field only appears if Flow Control is set to “On” in **Configure Screen 5** on page 30. The selections made will affect the display in **Manual Override Screen** on page 22. Choose the desired selection as defined below:

Selection	Description
Off	Normal operation
% Open	Flow control regulator is opened to a desired percentage.
Pressure	Flow control regulator is opened to a calibrated pressure.
ExtSP	External Setpoint. The regulator output voltage is set to a percentage of full scale. The range is 0 to 10000 which correlates to 0 to 100.00%. The register used for this is setup.Reg-ManualPercent, at address 40120.

Manual Override

This field only appears if Run Mode is set to “Automatic” or “Semi-automatic” in **Configure Screen 3**, page 30. Set to “On: EK” to override all outside control using the Manual Override “Flow Set Point” control to set the flow rate. Set it to “On: EXT” to use the Flow Set Source on **Configure Screen 6**, page 31 to determine if the flow rate is set from the Discrete or the Network input. If selected, the **Manual Override Screen** (page 22) will be added, and the Flow Control Override field appears (see above).

Gun 1/Gun2 Potlife Volume

Enter the potlife volume (1 to 1999 cc) for each gun. This is the amount of material required to move through the mix manifold, hose and applicator/gun before the potlife timer is reset.

Use the following information to determine approximate pot life volume (PLV) in cc:

Hose ID (inches)	Volume (cc/foot)*
3/16	5.43
1/4	9.648
3/8	21.71

Integrator manifold and mixer volume = 75 cc
Spray Gun Volume = 20 cc

$(\text{Hose Volume} * \text{x Feet of Hose}) + 75 + 20 = \text{PLV}$

Color/Catalyst Purge

NOTE: ProControl 1KS uses Color only.

This field only appears if the system includes a color change module and Flush and Fill Input is set to “Global” in **Option Screen 1**, page 32. Enter the purge time (0 to 99 seconds). It refers to the amount of time required to flush the lines from the color or catalyst module to the dose valve or dump valve.

Color/Catalyst Fill

NOTE: ProControl 1KS uses Color only.

This field only appears if the system includes a color change module and Flush and Fill Input is set to “Global” in **Option Screen 1**, page 32. Enter the fill time (0 to 99 seconds). It refers to the time required to fill the lines from the color or catalyst module to the dose valve or dump valve.

Advanced Setup Screen 2

Recipe Global							
First Purge Source	Air	↓	↑				
Chop Type	Air/Solvent	↓	2				
Final Purge Source	Solvent	↓	10				
Air Chop Time	2.0	sec					
Solvent Chop Time	2.0	sec					
<table border="1"> <tr> <td>Advanced</td> <td>Recipe</td> <td>Calibration</td> <td>Home</td> </tr> </table>				Advanced	Recipe	Calibration	Home
Advanced	Recipe	Calibration	Home				

FIG. 38. Advanced Setup Screen 2

This screen appears only if Flush and Fill Input is set to "Global" in **Option Screen 1**, page 32.

First Purge Source

Select "Air," "Solvent," or "3rd Flush Valve" (available only if 3rd Flush Valve is set to "On" in **Configure Screen 3** on page 30).

Chop Type

Select "Air/Solvent" or "Air/3rd Flush Valve" (available only if 3rd Flush Valve is set to "On" in **Configure Screen 3** on page 30). This refers to the process of mixing air and solvent (or air and 3rd flush fluid) together during the flush cycle, to help clean the lines and reduce solvent usage.

Final Purge Source

Select "Air," "Solvent," or "3rd Flush Valve" (available only if 3rd Flush Valve is set to "On" in **Configure Screen 3** on page 30).

Air Chop Time

Enter the air chop time (0.0 to 99.9 seconds).

Solvent Chop Time/3rd Flush Valve Chop Time

Enter the solvent or 3rd flush valve chop time (0.0 to 99.9 seconds).

Advanced Setup Screen 3

Recipe Global							
First Purge Time	10	sec	↑				
Total Chop Time	20	sec					
Final Purge Time	10	sec	3				
Mixed Fill Time	10	sec	10				
<table border="1"> <tr> <td>Advanced</td> <td>Recipe</td> <td>Calibration</td> <td>Home</td> </tr> </table>				Advanced	Recipe	Calibration	Home
Advanced	Recipe	Calibration	Home				

FIG. 39. Advanced Setup Screen 3

This screen appears only if Flush and Fill Input is set to "Global" in **Option Screen 1**, page 32.

If Number of Guns is set to "2" in **Configure Screen 4**, page 30, a Gun 2 column will appear in this screen.

First Purge Time

Enter the first purge time (0 to 999 seconds).

Total Chop Time

Enter the total chop time (0 to 999 seconds).

Final Purge Time

Enter the final purge time (0 to 999 seconds).

Mixed Material Fill Time

Enter the mixed material fill time (0 to 999 seconds). It refers to the amount of time that is required to load mixed material from the dose valves to the applicator/gun.

Advanced Setup Screen 4

Recipe Global		
K-Factor	cc/pulse	↑
A Meter	0.119	4
Solvent Meter	0.119	10
		↓
Advanced	Recipe	Calibration
		Home

FIG. 40. Advanced Setup Screen 4

This screen appears only if K-factor Input is set to "Global" in **Option Screen 1**, page 32.

K-factor A Meter

Enter the k-factor (cc/pulse) for flow meter A. This is the amount of material that passes through the flow meter per pulse (electrical pulse signal).

K-factor Solvent Meter

This field only appears if Solvent Monitor in **Configure Screen 5**, page 30, is set to "Meter." Enter the k-factor (cc/pulse) for the solvent flow meter.

Advanced Setup Screen 5

Flow Control		
Range	0-1200 ↓	cc/min ↑
Tolerance	5 %	
Alarm Time	99 sec	5
Ki	25	10
Kp	500	
Kd	4000	↓
Advanced	Recipe	Calibration
		Home

FIG. 41. Advanced Setup Screen 5 (Automatic Mode with Flow Control Only)

This screen appears only if Flow Control is set to either "On" or "On: Setup" in **Configure Screen 5**, page 30.

Range

Enter the flow rate range (0-300, 0-600, or 0-1200). This determines the flow control PID loop resolution.

Tolerance

Enter the flow rate tolerance (1 to 99%). This is the percentage of variance that the system will allow before a flow rate warning/alarm occurs.

Alarm Time

Enter the flow rate alarm time (1 to 99 seconds).

Ki

Enter the flow rate Ki (flow control PID loop integral value). Output drive amount based on the accumulation of error between the command and measured pressures scaled to the output transducer.

Kp

Enter the flow rate Kp (flow control PID loop proportional value). Output drive amount based on the instantaneous error between the command and measured pressures scaled to the output transducer.

Kd

Enter the flow rate Kd (flow control PID loop derivative value). Output drive amount based on the change of error between the command and measured pressures scaled to the output transducer.

Advanced Setup Screen 6

Flow Control Learning							
One-Point threshold	<input type="text" value="0"/>	cc/min	↑				
Learn Strength	<input type="text" value="20"/>	%					
Pressure zero offset	<input type="text" value="+0.00"/>	PSI	6				
Pressure intercept	<input type="text" value="+0.00"/>	PSI	10				
↓							
<table border="1" style="width: 100%; text-align: center;"> <tr> <td>Advanced</td> <td>Recipe</td> <td>Calibration</td> <td>Home</td> </tr> </table>				Advanced	Recipe	Calibration	Home
Advanced	Recipe	Calibration	Home				

FIG. 42. Advanced Setup Screen 6

This screen appears only if Flow Control is set to either “On” or “On: Setup” in **Configure Screen 5**, page 30.

One-Point threshold

Flow Control runs in Pressure mode for flow setpoints below this value. If the setpoint is at or above this value, a linear calibration is made from (0, 0) to the point.

Learn Strength

This controls how much of the flow error signal is applied when adjusting the Pressure-Flow curve. It will always target the same flow. Because the flow control drives to pressure, the reported flow rate may jump around. However, if the material is consistent and the pressure is constant, then the actual flow is correct.

Pressure zero offset

Zero-pressure calibration adjustment for pressure sensor. Used primarily for accurate flow rate calculation in Pressure mode. This is added to the pressure reading, so a negative value zeroes out a positive offset.

Pressure intercept

Pressure-axis intercept of Pressure-Flow curve to match the slope with the actual response.

Advanced Setup Screen 7

Flow Control Tuning							
Command holdoff	<input type="text" value="350"/>	ms	↑				
Gun trigger holdoff	<input type="text" value="350"/>	ms					
GT-Off drive time	<input type="text" value="99"/>	s	7				
GT-Off target rise	<input type="text" value="1.00"/>	PSI10					
Purge drive	<input type="text" value="3000"/>	mV					
Valve holdoff maximum	<input type="text" value="1000"/>	ms	↓				
↓							
<table border="1" style="width: 100%; text-align: center;"> <tr> <td>Advanced</td> <td>Recipe</td> <td>Calibration</td> <td>Home</td> </tr> </table>				Advanced	Recipe	Calibration	Home
Advanced	Recipe	Calibration	Home				

FIG. 43. Advanced Setup Screen 7

This screen appears only if Flow Control is set to “On” in **Configure Screen 5**, page 30.

Command holdoff

Learn blanking time after setpoint command change. Flow learning is turned off during this interval. May be reduced for systems that have less than around x2 from minimum to maximum pressure setpoints. May need to be increased for systems with wide pressure swings.

Gun trigger holdoff

Learn blanking time after gun trigger is opened. Flow learning is turned off during this interval. May be reduced for high-pressure systems. May need to be increased for low-pressure systems.

GT-Off drive time

Time to drive to pressure while the gun trigger is off.

GT-Off target rise

The additional pressure to control to based on flow rate setpoint when the gun is closed. This allows the system to be close to the pressure target when the gun is opened.

Purge drive

Output drive during the Purge sequence. Maximum of 3300 mV.

Valve holdoff maximum

The maximum learn blanking time after dose valve change. This is adjusted based on how much learning was needed per dose changeover up to this maximum value.

Advanced Setup Screen 8

<input type="checkbox"/> Recipe Bit 0	<input type="checkbox"/> FC Calibrate	↑ 8 / 10 ↓
<input type="checkbox"/> Recipe Bit 1	<input type="checkbox"/> FC Cal Active	
<input type="checkbox"/> Recipe Bit 2	Flow Input	
<input type="checkbox"/> Recipe Bit 3	0.0 Volts	
<input type="checkbox"/> Recipe Bit 4	<input type="checkbox"/> Ext CC Input	
<input type="checkbox"/> Recipe Bit 5	<input type="checkbox"/> Solvent Push	
run.RDI: 0000 run.RDO: 0404		
<div style="display: flex; justify-content: space-between; border: 1px solid black; padding: 2px;"> Advanced Recipe Calibration Home </div>		

FIG. 44. Advanced Setup Screen 8

This screen shows the status of digital inputs, digital outputs, and the Flow Control voltage input. If box is shaded the input is active. If not, input is off. See pages 52-54 for details on the inputs and outputs.

Advanced Setup Screen 9

<input type="checkbox"/> Mix	<input type="checkbox"/> Purge Active	↑ 9 / 10 ↓
<input type="checkbox"/> Purge	<input type="checkbox"/> Fill Active	
<input type="checkbox"/> Recipe Change	<input type="checkbox"/> Mix Active	
<input type="checkbox"/> Gun Trigger	<input checked="" type="checkbox"/> Mix Ready	
<input type="checkbox"/> Job Complete	<input type="checkbox"/> General Alarm	
<input type="checkbox"/> Remote Stop	<input type="checkbox"/> Potlife Alarm	
<input type="checkbox"/> Reset Alarm	<input type="checkbox"/> Flow Alarm	
run.RDI: 0000 run.RDO: 0404		
<div style="display: flex; justify-content: space-between; border: 1px solid black; padding: 2px;"> Advanced Recipe Calibration Home </div>		

FIG. 45. Advanced Setup Screen 9

This screen shows the status of digital inputs and digital outputs. If box is shaded the input is active. If not, input is off. See pages 52-54 for details on the inputs and outputs.

Advanced Setup Screen 10

Recipe Global					↑ 10 / 10 ↓
Special	1	2	3	4	
On-Purge	<input checked="" type="checkbox"/>	<input type="checkbox"/>	<input type="checkbox"/>	<input type="checkbox"/>	
Length	<input type="text" value="0"/>	<input type="text" value="0"/>	<input type="text" value="0"/>	<input type="text" value="0"/> sec	
On-Fill	<input type="checkbox"/>	<input type="checkbox"/>	<input type="checkbox"/>	<input type="checkbox"/>	
Length	<input type="text" value="0"/>	<input type="text" value="0"/>	<input type="text" value="0"/>	<input type="text" value="0"/> sec	
<div style="display: flex; justify-content: space-between; border: 1px solid black; padding: 2px;"> Advanced Recipe Calibration Home </div>					

FIG. 46. Advanced Setup Screen 10

This screen appears only if Flush and Fill Input is set to "Global" in **Option Screen 1**, page 32 and Special Outputs is set to 1, 2, 3, 4, or 3 + GFB on #4 in **Configure Screen 5**, page 30. The I/O board has four programmable outputs.

NOTE: If 3 + GFB on #4 is selected, this screen will only display columns for Special 1, 2, and 3. Column Special 4 is not displayed because this output has assumed the same settings as those assigned to the Gun Flush Box #1.

On-Purge

Delay time at the start of the purge cycle before the Special Output turns on.

Length

Duration for the Special Output to be active during the purge cycle.

On-Fill

Delay time at the start of the fill cycle before the Special Output turns on.

Length

Duration for the Special Output to be active during the fill cycle.

Recipe Setup Screens

NOTE: See FIG. 47 for a map of the Recipe screens. Detailed screen descriptions follow.

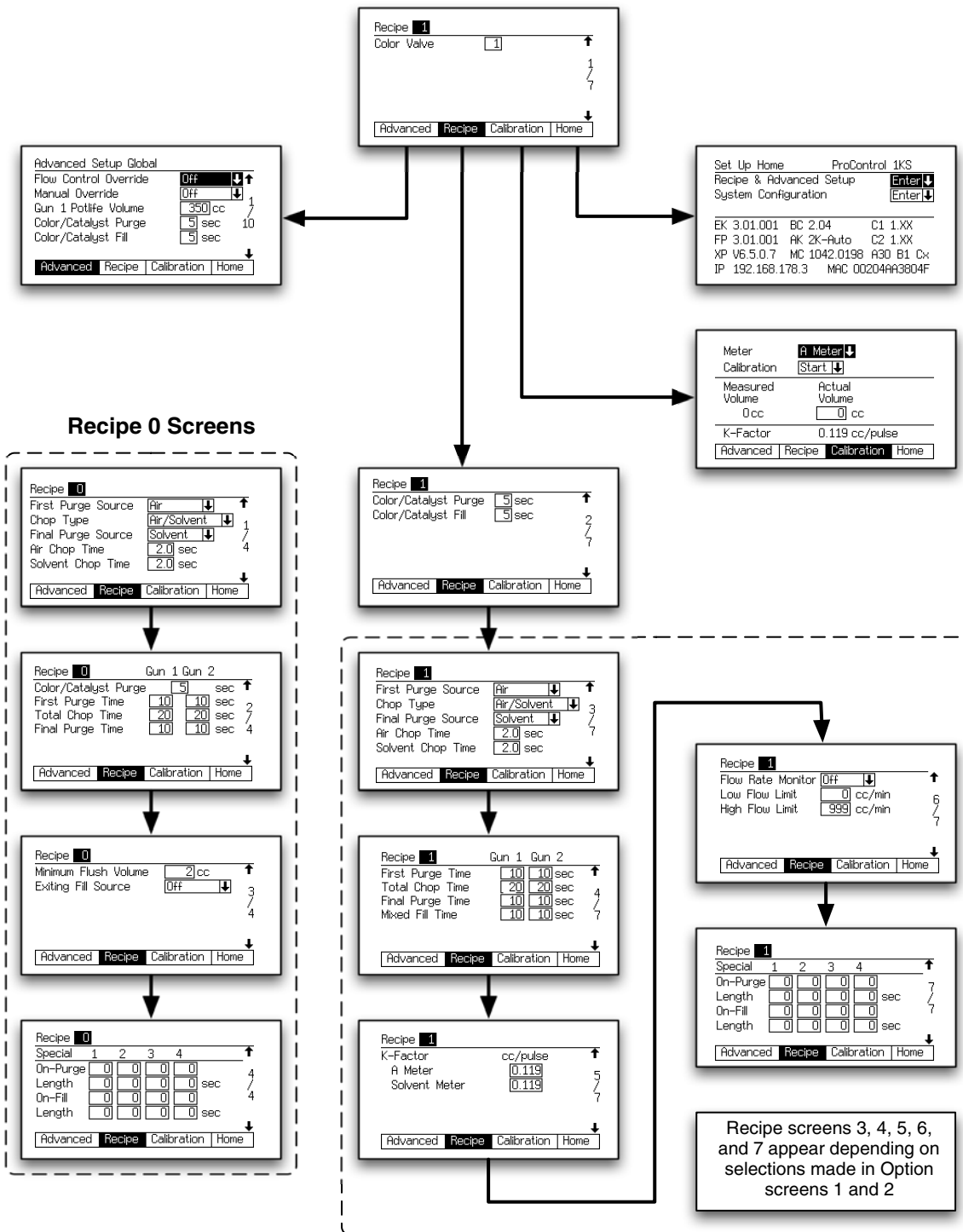

T112806a

FIG. 47: Recipe Screens Map

NOTE: Each screen displays the current screen number and the total number of screens in the group. The total number of screens in a group and the fields displayed on each screen may vary depending on selections made in the **System Configuration Screens** and **Option Screens**.

Recipe Setup Screen 1

FIG. 48. Recipe Setup Screen 1

Color Valve

This field only appears if the system includes a color change module. Enter the color valve number (1 to 30).

Recipe Setup Screen 2

FIG. 49. Recipe Setup Screen 2

Minimum Flush Volume

This field only appears if Flush Volume Check is set to "On" in **Option Screen 1** on page 32. Enter the minimum flush volume (0 to 9999 cc). Entering 0 disables this function.

Color/Catalyst Purge

NOTE: ProControl 1KS uses Color only.

This field only appears if the system includes a color change module and Flush and Fill Input is set to "Recipe" in **Option Screen 1**, page 32. Enter the purge time (0 to 99 seconds). It refers to the amount of time required to flush the lines from the color or catalyst module to the dose valve or dump valve.

Color/Catalyst Fill

NOTE: ProControl 1KS uses Color only.

This field only appears if the system includes a color change module and Flush and Fill Input is set to "Recipe" in **Option Screen 1**, page 32. Enter the fill time (0 to 99 seconds). It refers to the time required to fill the lines from the color or catalyst module to the dose valve or dump valve.

Recipe Setup Screen 3

Recipe 1		
First Purge Source	Air ↓	↑
Chop Type	Air/Solvent ↓	3
Final Purge Source	Solvent ↓	7
Air Chop Time	2.0 sec	
Solvent Chop Time	2.0 sec	
↓		
Advanced	Recipe	Calibration Home

FIG. 50. Recipe Setup Screen 3

This screen appears only if Flush and Fill Input is set to "Recipe" in **Option Screen 1**, page 32.

First Purge Source

Select "Air," "Solvent," or "3rd Flush Valve" (available only if 3rd Flush Valve is set to "On" in **Configure Screen 3** on page 30).

Chop Type

Select "Air/Solvent" or "Air/3rd Flush Valve" (available only if 3rd Flush Valve is set to "On" in **Configure Screen 3** on page 30). This refers to the process of mixing air and solvent (or air and 3rd flush fluid) together during the flush cycle, to help clean the lines and reduce solvent usage.

Final Purge Source

Select "Air," "Solvent," or "3rd Flush Valve" (available only if 3rd Flush Valve is set to "On" in **Configure Screen 3** on page 30).

Air Chop Time

Enter the air chop time (0.0 to 99.9 seconds).

Solvent Chop Time/3rd Flush Valve Chop Time

Enter the solvent or 3rd flush valve chop time (0.0 to 99.9 seconds).

Recipe Setup Screen 4

Recipe 1	Gun 1	Gun 2	
First Purge Time	10	10	sec ↑
Total Chop Time	20	20	sec 4
Final Purge Time	10	10	sec 7
Mixed Fill Time	10	10	sec 7
↓			
Advanced	Recipe	Calibration	Home

FIG. 51. Recipe Setup Screen 4

This screen appears only if Flush and Fill Input is set to "Recipe" in **Option Screen 1**, page 32.

In Automatic mode, only one gun is allowed. In Semi-automatic mode, two guns are allowed. If Number of Guns is set to "2" in **Configure Screen 4**, page 30, a Gun 2 column will appear in this screen.

First Purge Time

Enter the first purge time (0 to 999 seconds).

Total Chop Time

Enter the total chop time (0 to 999 seconds).

Final Purge Time

Enter the final purge time (0 to 999 seconds).

Mixed Material Fill Time

Enter the mixed material fill time (0 to 999 seconds). It refers to the amount of time that is required to load mixed material from the dose valves to the applicator/gun.

Recipe Setup Screen 5

Recipe 1		
K-Factor	cc/pulse	↑
A Meter	<input type="text" value="0.119"/>	5
Solvent Meter	<input type="text" value="0.119"/>	7
		↓
Advanced	Recipe	Calibration
		Home

FIG. 52. Recipe Setup Screen 5

This screen appears only if K-factor Input is set to “Recipe” in **Option Screen 1**, page 32.

K-factor A Meter

Enter the k-factor (cc/pulse) for flow meter A. This is the amount of material that passes through the flow meter per pulse (electrical pulse signal).

K-factor Solvent Meter

This field only appears if Solvent Monitor is set to “Meter” in **Configure Screen 5**, page 30. Enter the k-factor (cc/pulse) for the solvent flow meter.

Recipe Setup Screen 6

Recipe 1		
Flow Rate Monitor	<input type="text" value="Off"/>	↓
Low Flow Limit	<input type="text" value="0"/> cc/min	6
High Flow Limit	<input type="text" value="999"/> cc/min	7
		↓
Advanced	Recipe	Calibration
		Home

FIG. 53. Recipe Setup Screen 6

This screen appears only if Flow Rate Monitor is set to “On” in **Option Screen 2** on page 33.

Flow Rate Monitor

Select the desired flow rate monitoring (Off, Warning, or Alarm).

Low Flow Limit

Enter the low flow rate limit (1 to 3999 cc/min).

High Flow Limit

Enter the high flow rate limit (1 to 3999 cc/min).

Recipe Setup Screen 7

Recipe 1									
Special	1	2	3	4	↑				
On-Purge	<input type="text" value="0"/>	<input type="text" value="0"/>	<input type="text" value="0"/>	<input type="text" value="0"/>	7 / 7				
Length	<input type="text" value="0"/>	<input type="text" value="0"/>	<input type="text" value="0"/>	<input type="text" value="0"/>		sec			
On-Fill	<input type="text" value="0"/>	<input type="text" value="0"/>	<input type="text" value="0"/>	<input type="text" value="0"/>	↓				
Length	<input type="text" value="0"/>	<input type="text" value="0"/>	<input type="text" value="0"/>	<input type="text" value="0"/>		sec			
<table border="1"> <tr> <td>Advanced</td> <td>Recipe</td> <td>Calibration</td> <td>Home</td> </tr> </table>					Advanced	Recipe	Calibration	Home	
Advanced	Recipe	Calibration	Home						

FIG. 54. Recipe Screen 7

This screen appears only if Flush and Fill Input is set to “Recipe” in **Option Screen 1**, page 32 and Special Outputs is set to 1, 2, 3, or 4 in **Configure Screen 5**, page 30. The I/O board has four programmable outputs.

On-Purge

Delay time at the start of the purge cycle before the Special Output turns on.

Length

Duration for the Special Output to be active during the purge cycle.

On-Fill

Delay time at the start of the fill cycle before the Special Output turns on.

Length

Duration for the Special Output to be active during the fill cycle.

Recipe 0 Screens

NOTE: See FIG. 47 on page 40 for a map of the Recipe 0 screens. Detailed screen descriptions follow.

Recipe 0 is typically used in multiple color systems to purge out material lines without loading a new color

NOTE: Each screen displays the current screen number and the total number of screens in the group. The total number of screens in a group and the fields displayed on each screen may vary depending on selections made in the **System Configuration Screens** and **Option Screens**.

Recipe 0 Screen 1

Recipe 0		
First Purge Source	Air ↓	↑
Chop Type	Air/Solvent ↓	1
Final Purge Source	Solvent ↓	7
Air Chop Time	2.0 sec	4
Solvent Chop Time	2.0 sec	
↓		
Advanced	Recipe	Calibration Home

FIG. 55. Recipe 0 Screen 1

First Purge Source

Select “Air,” “Solvent,” or “3rd Flush Valve” (available only if 3rd Flush Valve is set to “On” in **Configure Screen 3** on page 30).

Chop Type

Select “Air/Solvent” or “Air/3rd Flush Valve” (available only if 3rd Flush Valve is set to “On” in **Configure Screen 3** on page 30). This refers to the process of mixing air and solvent (or air and 3rd flush fluid) together during the flush cycle, to help clean the lines and reduce solvent usage.

Final Purge Source

Select “Air,” “Solvent,” or “3rd Flush Valve” (available only if 3rd Flush Valve is set to “On” in **Configure Screen 3** on page 30).

Air Chop Time

Enter the air chop time (0.0 to 99.9 seconds).

Solvent Chop Time/3rd Flush Valve Chop Time

Enter the solvent or 3rd flush valve chop time (0.0 to 99.9 seconds).

Recipe 0 Screen 2

Recipe 0	Gun 1	Gun 2	
Color/Catalyst Purge	5	sec	↑
First Purge Time	10	10	sec 2
Total Chop Time	20	20	sec 7
Final Purge Time	10	10	sec 4
↓			
Advanced	Recipe	Calibration	Home

FIG. 56. Recipe 0 Screen 2

If Number of Guns is set to “2” in **Configure Screen 4**, page 30, a Gun 2 column will appear in this screen.

Color/Catalyst Purge Time

NOTE: ProControl 1KS uses Color only.

This field only appears if the system includes a color change module. It refers to the amount of time required to flush the lines from the color or catalyst module to the dose valve or dump valve. Enter the purge time (0 to 999 seconds).

First Purge Time

Enter the first purge time (0 to 999 seconds).

Total Chop Time

Enter the total chop time (0 to 999 seconds).

Final Purge Time

Enter the final purge time (0 to 999 seconds).

Recipe 0 Screen 3

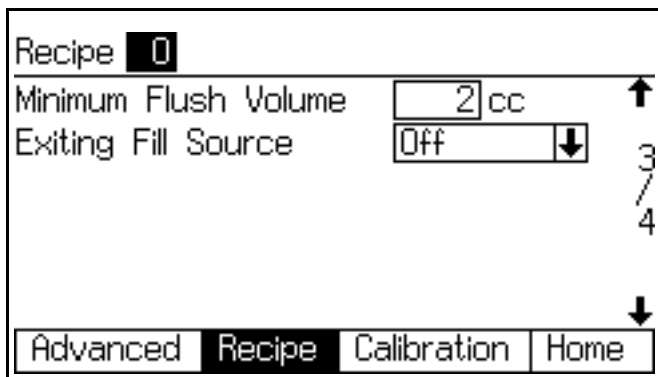

FIG. 57. Recipe 0 Screen 3

This screen only appears if Solvent Monitor is set to "Meter" in **Configure Screen 5**, page 30 and Flush Volume Check is set to "On" in **Option Screen 1**, page 32 or 3rd Flush Valve is set to "On" in **Configure Screen 3** on page 30.

Minimum Flush Volume

This field only appears if Flush Volume Check is set to "On" in **Option Screen 1** on page 32. Enter the minimum flush volume (0 to 9999 cc).

Exiting Fill Source

This field only appears if 3rd Flush Valve is set to "On" in **Configure Screen 3** on page 30. Select "Off," "Air," "Solvent," or "3rd Valve."

Exiting Fill Time

This field only appears if Exiting Fill Source is set to "Air," "Solvent," or "3rd Valve." Enter the time in seconds.

Recipe 0 Screen 4

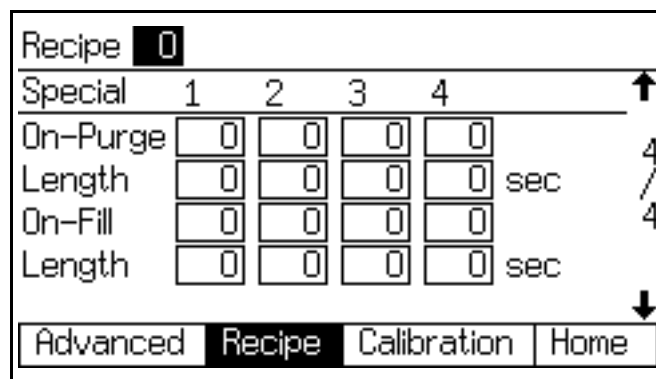

FIG. 58. Recipe 0 Screen 4

This screen appears only if Flush and Fill Input is set to "Recipe" in **Option Screen 1**, page 32 and Special Outputs is set to 1, 2, 3, or 4 in **Configure Screen 5**, page 30. The I/O board has four programmable outputs.

On-Purge

Delay time at the start of the purge cycle before the Special Output turns on.

Length

Duration for the Special Output to be active during the purge cycle.

On-Fill

Delay time at the start of the fill cycle before the Special Output turns on.

Length

Duration for the Special Output to be active during the fill cycle.

Calibration Screen

Meter	A Meter ↓
Calibration	Start ↓
Measured Volume	Actual Volume
0 cc	<input type="text" value="0"/> cc
K-Factor	0.119 cc/pulse
Advanced	Recipe
Calibration	Home

FIG. 59. Calibration Screen

Use this screen to calibrate a meter. Set to “A Meter” or “Solvent Meter” (available if Solvent Monitor in **Configure Screen 5**, page 30, is set to “Meter”).

- **Start** - start calibration
- **Abort** - stop calibration
- **Purge** - purge sampling valves after calibration

See **Meter Calibration**, page 102, for when and how to calibrate meter.

ProControl Integration Specifics

System Setup for Automatic Operation

Configuration of the options for ProControl 1KS Automatic operation is done through a few setup screens. Several utility screens are also available for debug and verification.

First, set the ProControl 1KS to Automatic mode:

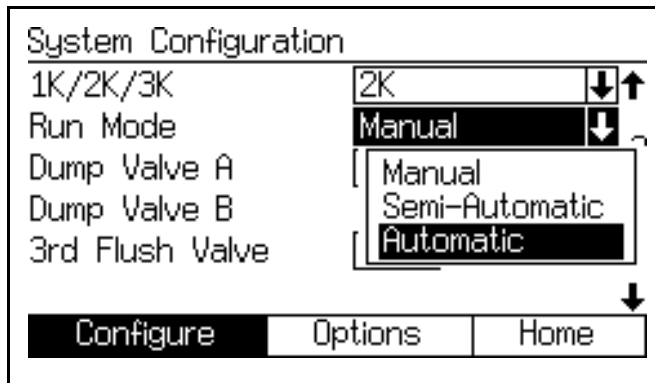

FIG. 60. Configure Screen 3

If Flow Control is used, then turn it on. There are two activation options: “On”, and “On: Setup”. The only difference is that “On: Setup” allows the display of the “Flow Control Tuning” screen.

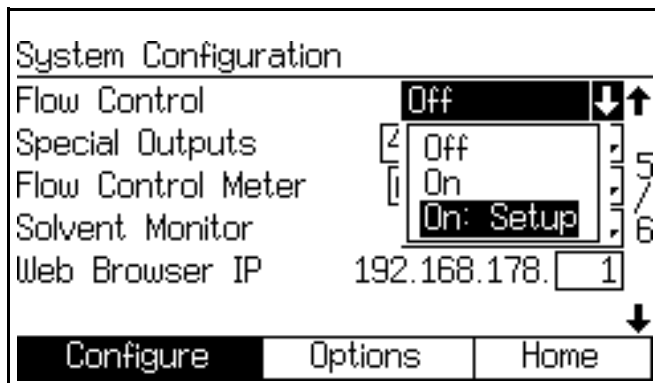

FIG. 61. Configure Screen 5

Several control interface options are available when using Automatic mode.

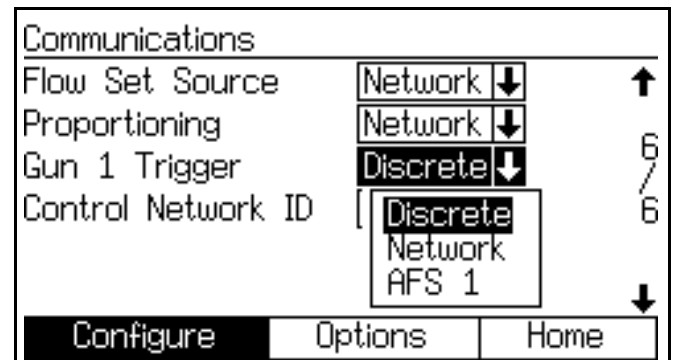

FIG. 62. Configure Screen 6

Flow Set Source

This appears only if Flow Control is turned on. Select “Discrete” or “Network”.

In Discrete mode control is driven through the analog voltage input. In Network mode control is driven through a Modbus register.

Proportioning

Select “Discrete” or “Network”.

In Discrete mode control is driven through the Discrete I/O board. In Network mode control is driven through a Modbus register.

NOTE: It is not possible to read back the active recipe number using the Discrete I/O interface.

Gun 1 Trigger

Select “Discrete”, “Network”, or “AFS 1”.

In Discrete mode the gun trigger control is read by an EasyKey digital input and sent to the Fluid Panel. In Network mode it is written to the EasyKey over the Modbus interface. In AFS 1 mode it is applied to the Fluid Panel in the Hazardous location.

NOTE: Discrete I/O is recommended. It is easy to connect in the normal location to the PLC. AFS 1 mode is used for special cases where the gun trigger timing is critical.

NOTE: Network gun trigger with Flow Control has a long time delay through the PLC to ProControl communications structure. This will negatively affect Flow Control operation.

Control Network ID

Select the Modbus address of the ProControl 1KS. The range is from 1 though 247.

Modbus communications for reading back information is available even when Discrete I/O control is enabled.

Status Verification of Automatic Operation

Several screens allow viewing of control interface status information.

Discrete I/O bits as used on the ProControl 1KS are available in **Advanced Setup Screen 8** and **Advanced Setup Screen 9** If control is through the Network interface the status data comes from those registers.

This data is updated live.

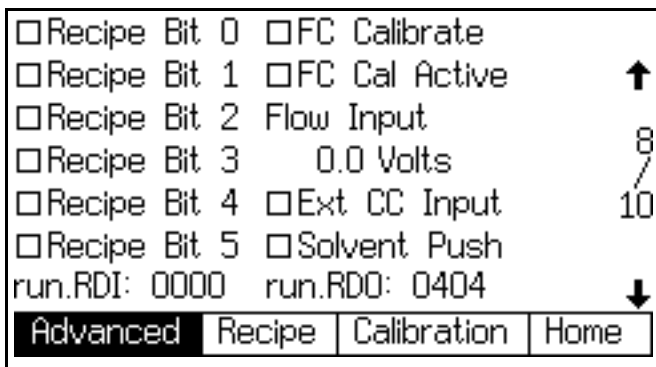

FIG. 63. Advanced Setup Screen 8

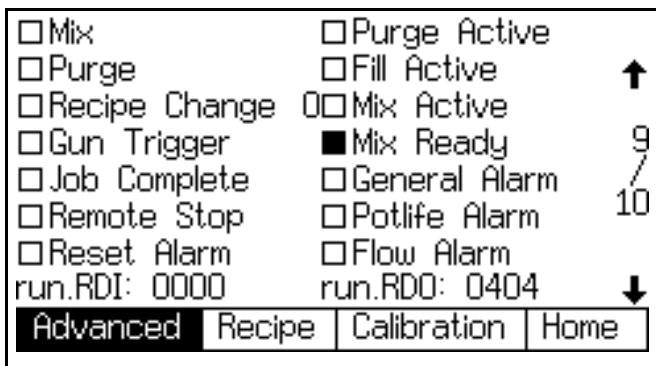

FIG. 64. Advanced Setup Screen 9

Discrete I/O vs Network Communications

The ProControl 1KS Automatic system does not use a Booth Control. Instead, it uses Discrete I/O or Network Communications to drive the system. Each method can be used exclusively, or both at the same time.

In Automatic mode, the following fields can be set to “Discrete” or “Network” (see **Configure Screen 6** on page 31):

- Flow Control
- Proportioning
- Gun 1 Trigger

NOTE: In Semi-automatic mode, only the Proportioning field is available.

NOTE: The Manual Override function enables you to operate the system before the automation (PLC) is available. Manual Override still requires some communication through Discrete I/O or Network Communications. Although Manual Override is not intended to be the main mode of control, it can be used if proper Gun Trigger Input is provided.

Discrete I/O

Discrete I/O requires a 24 Vdc power supply which must be supplied on site. The ProControl does not supply power for Discrete I/O.

See Table 4 on page 54, FIG. 73 on page 63, and Table 9 on page 64 for inputs and outputs. Understanding these inputs and outputs is necessary to properly integrate the ProControl 1KS to the automation.

Input and output connections are made at the Discrete I/O terminal strips (FIG. 66) and the discrete I/O board (FIG. 67) inside the EasyKey. Also see the **System Electrical Schematic** on page 131.

Review the Color Change Charts (FIG. 110-FIG. 119). A full understanding of the color change sequence is necessary to properly drive the inputs and monitor the outputs.

See **Advanced Setup Screen 9**, page 39. This screen shows the actual status of all inputs and outputs. It is important to ensure that each input from local automation (PLC) is received by the EasyKey and to verify that the ProControl 1KS is sending outputs to the automation.

The following paragraphs describe each discrete I/O function in detail.

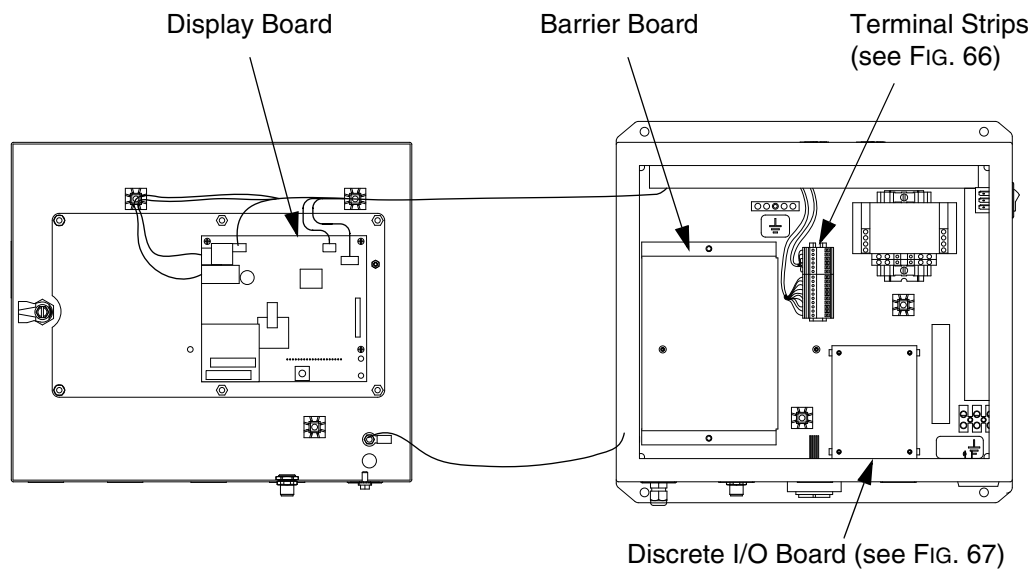

T112496a

FIG. 65: EasyKey Control Boards

Digital Inputs

See **Automation Flow Charts**, pages 55-59.

Mix Start: This is a *maintained* input. When High, the ProControl 1KS will attempt to enter Mix mode. This Mix Start input should not be attempted unless the Mix_Ready output is recognized. This ensures that there are no alarms and that the Mix Start input is appropriate.

This input stays High at all times when mixing on demand is required. When Low, the intent is to stop mixing material and perform a purge or recipe change.

Do not toggle this input to set the unit to Standby mode during short work stoppages. The ProControl 1KS will automatically go into Idle mode after 2 minutes of inactivity. When a Gun Trigger input is seen, the ProControl 1KS will automatically leave Idle mode and resume mixing material where it left off.

Purge Start: This is a *maintained* input. When recognized by the ProControl 1KS, the Purge Sequence will start, using the Purge Time from the active recipe. This will also include the Solvent Fill Time. Proper monitoring of the Purge/Color Change Output is required to ensure this function has begun. Once this output is removed, the system will immediately go to Standby mode.

Color Change Start: This is a *momentary* input, 100 msec minimum. When recognized by the ProControl 1KS, the Color Change sequence will begin, starting at the Color/Catalyst Dump.

NOTE: If the new recipe has the *same color* as the active recipe, then the Color/Catalyst Dump and Color/Catalyst Fill times are skipped and the Color Change Sequence starts with the Purge. Also, the recipe bit configuration for the Color Change must be loaded at least 100 msec before the Color Change Start input is turned on. The recipe bit configuration *must* remain on while the Color Change Start input is removed. Graco recommends the recipe bits stay active and do not change until a new color is required. The PLC should monitor the Purge/Color Change Output as well as the Fill Active Output to ensure the process happens as required. A complete color change without errors (resulting in a Mix Ready Output state) is a completed color change.

NOTE: This also applies if using the Modbus Registers (see the Modbus Map table in manual 312785).

Gun Trigger: When High, this input signals the ProControl 1KS that the gun is actually triggered. It should be sent every time the gun is triggered. This input provides timing for alarm functions and also drives the flow control functions. Without it, no flow control functions will start.

Job Complete: This is a *momentary* input, 100 msec minimum. When recognized by the ProControl 1KS, the Job totals are cleared and a time/date stamp is added for retrieval.

Remote Stop: Use this input when external equipment is used to stop the system. Clear any alarms before using this input. For more information about when this input is needed, contact your Graco distributor.

Alarm Reset: This is a *momentary* input, 100 msec minimum. When recognized by the ProControl 1KS it clears any active alarms and allows the automation to take the next step.

Common: This is not an input, but the ProControl 1KS expects to have the COM side of the 24 Vdc supply connected as shown in Table 9. This ensures proper operation of each input and output.

I/O Terminal Strip Detail

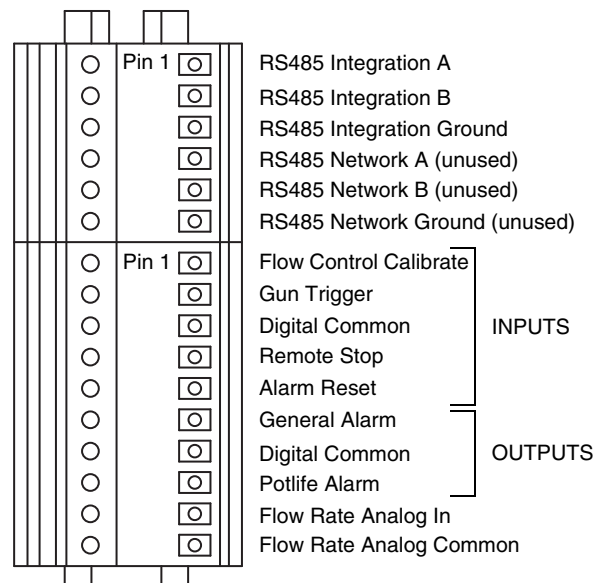

TI12958a

Fig. 66: EasyKey Terminal Strips

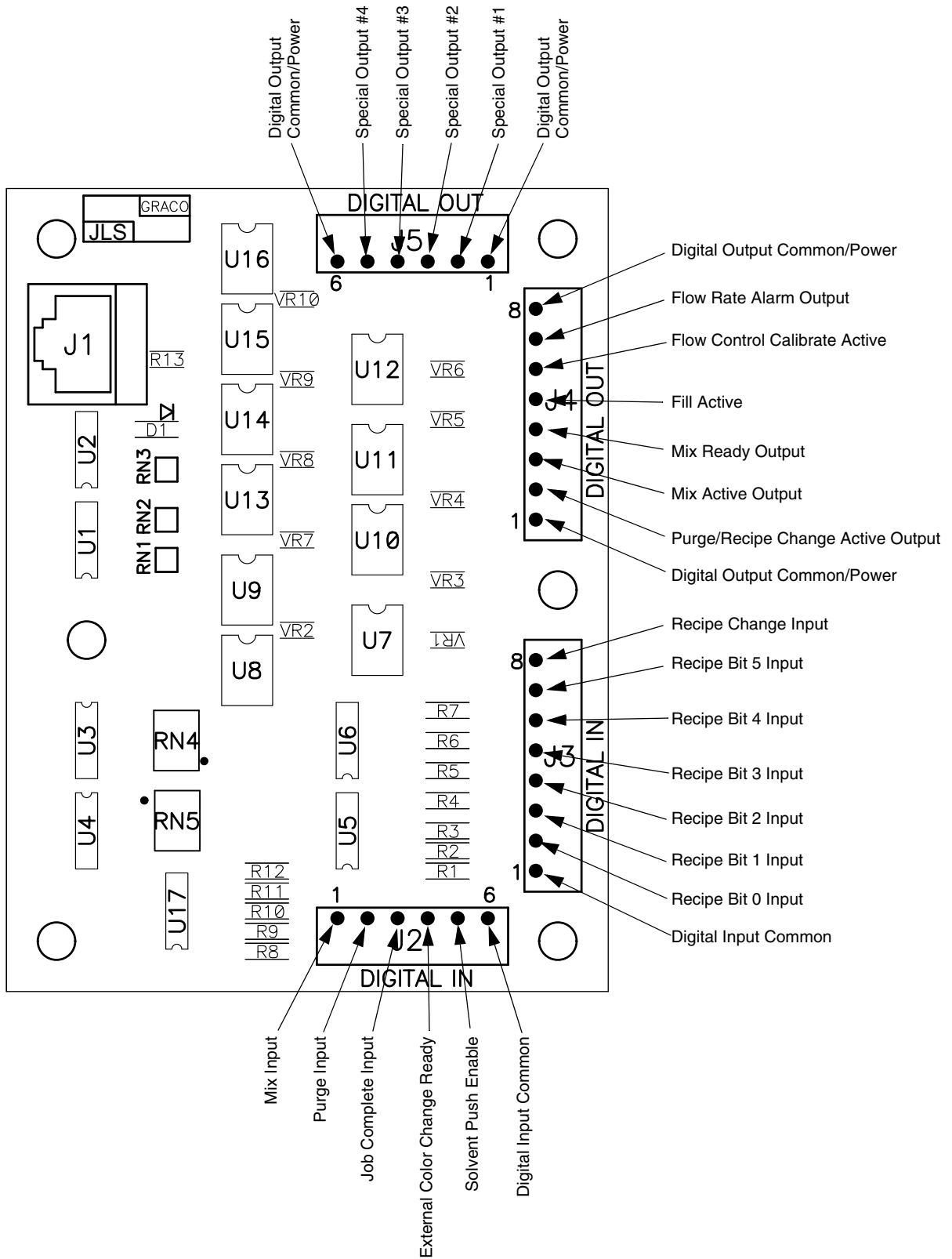

FIG. 67: 255766 Discrete I/O Board

Digital Outputs

See **Automation Flow Charts**, pages 55-59.

Purge_CC_Active: This output will remain High during the manual Purge or Color Change purge sequence. See the Color Change Charts (FIG. 110-FIG. 119) for further information.

Fill_Active: This output will remain High while the ProControl 1KS is in the Mixed Material Fill at the end of a typical color change sequence.

Mix_Active: This output will remain High while the ProControl 1KS is in Mix mode. There may be alarm outputs while this output is High; these are typically High/Low Flow Warnings. Always monitor this output and the alarm outputs to provide feedback of the actual status of the ProControl 1KS. (See the Modbus charts in the Graco Gateway manual 312785.)

Mix_Ready: This output will remain High while there are no alarms and the ProControl 1KS is ready to go to Mix mode.

General Alarm: This output will remain High when any alarm is active. See Table 17 on page 118 for a complete list of alarms.

NOTE: It is important to monitor this output along with Mix_Active to understand the alarm's true meaning.

Alarm_Potlife: This output will remain High along with the Alarm output when the potlife time has been reached for the active recipe. The Mix_Active output will drop Low, even if the Mix_Start input is High. This output will remain High until the potlife volume is dispensed or the ProControl 1KS completes a Purge or a Color Change. The Alarm Reset input will not stop this output but will silence the audible alarm on the EasyKey.

NOTE: The Alarm Reset  key will also reset the audible alarm.

To dispense the potlife volume, the ProControl 1KS Mix_Start input must be turned Off then back to High to spray material. At this point, Mix_Active, Alarm, and Alarm_Potlife outputs will be High until the potlife volume is sprayed.

Digital Out Supply: This is the supply for the digital outputs. It is the same supply for the digital inputs. (See **Common** under **Digital Inputs**, page 52.)

Analog Inputs

Flow Command: This is the positive side of the 0 – 10 Vdc signal. (See **Common** under **Digital Inputs**, page 52.) This input corresponds to the Flow Range setting in **Advanced Setup Screen 5**, page 37. *For example*, if the setting is 0 – 300 cc/min, the 0 Vdc analog input is 0 cc/min, therefore the 10 Vdc analog input is 300 cc/min.

Table 4: Sourcing/Sinking Inputs and Outputs

Inputs (Automation Sourcing)			
1	Flow Control Calibration	Black	+
2	Gun Trigger	White	+
3	Digital In Common	Red	-
4	Remote Stop	Green	+
5	Alarm Reset	Brown	+
Outputs (Automation Sourcing)			
6	Alarm Output	Blue	+
7	Digital Out Common	Orange	-
8	Pot Life	Yellow	+
Outputs (Automation Sinking)			
6	Alarm Output	Blue	-
7	+24 Volts	Orange	+
8	Pot Life	Yellow	-
Automation			
9	Flow Rate Analog In	Purple	+
10	Flow Rate Analog Common	Gray	-

Automation Flow Charts

Start Mix Mode Process

See FIG. 68, Table 5, and Table 6.

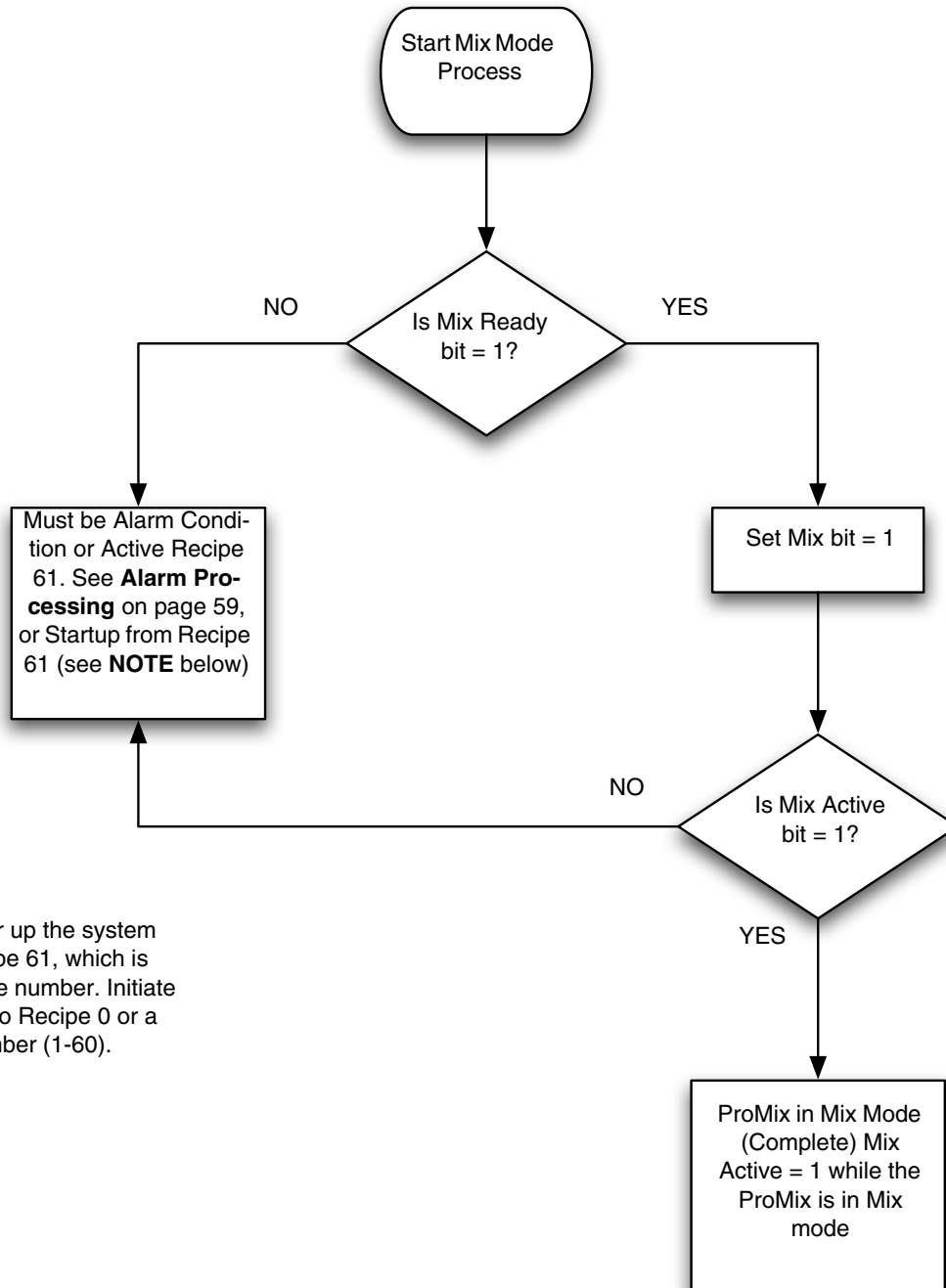

NOTE: At power up the system defaults to Recipe 61, which is not a valid recipe number. Initiate a color change to Recipe 0 or a valid recipe number (1-60).

FIG. 68. Start Mix Mode Process Flow Chart

Mixing Mode Process

See FIG. 69, Table 5, and Table 6.

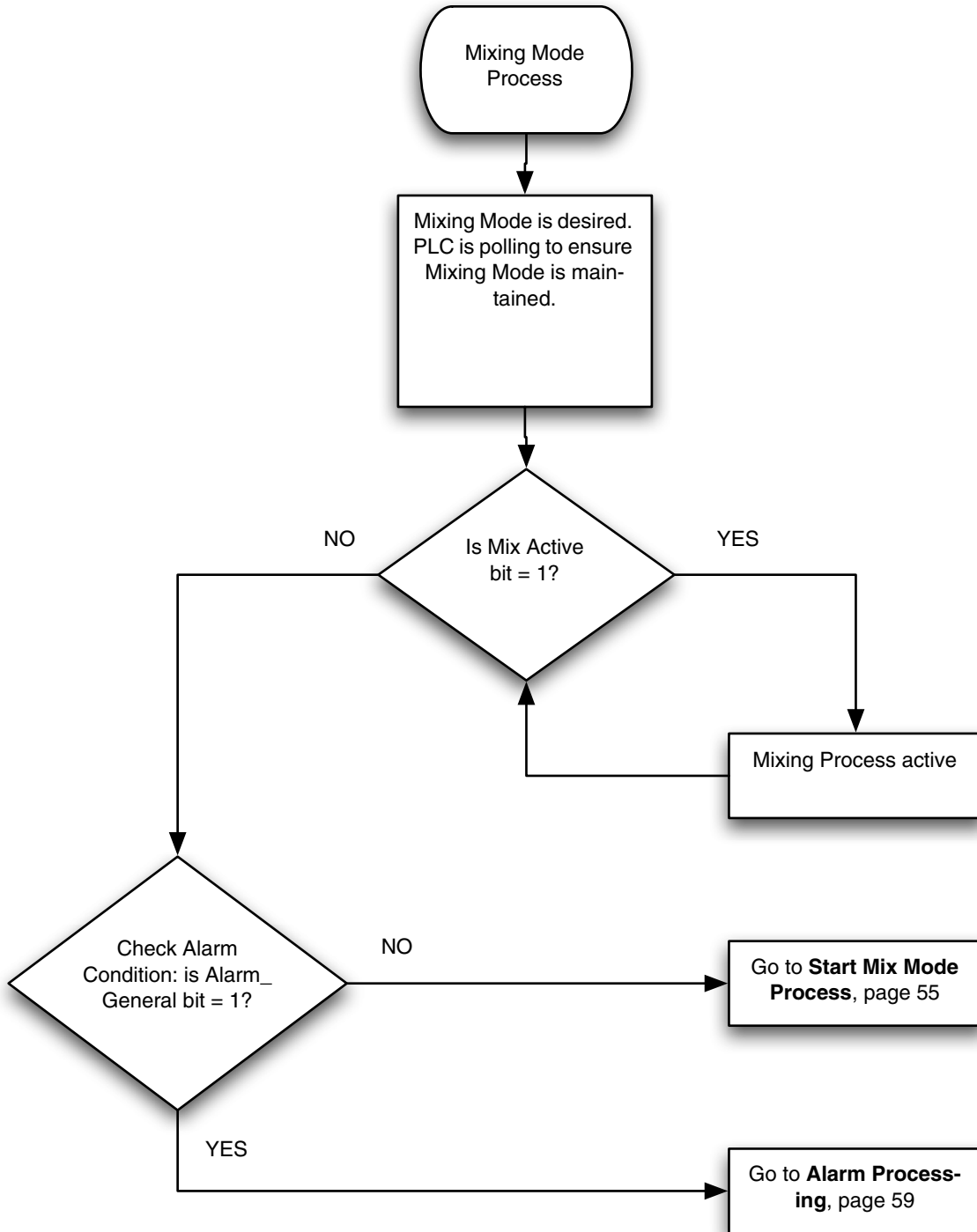
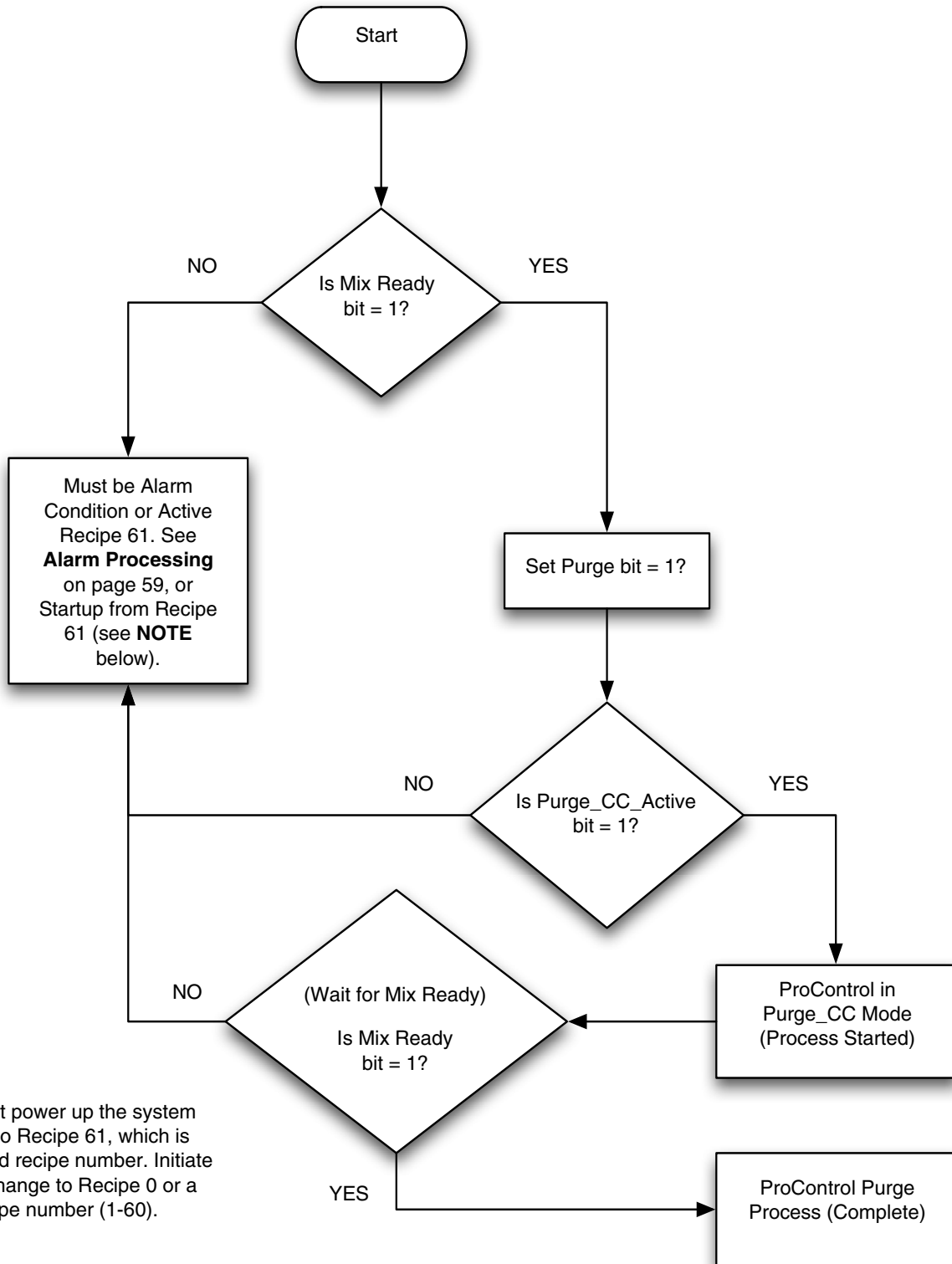

FIG. 69. Mixing Mode Process Flow Chart

Purge Mode Process

See FIG. 70, Table 5, and Table 6.



NOTE: At power up the system defaults to Recipe 61, which is not a valid recipe number. Initiate a color change to Recipe 0 or a valid recipe number (1-60).

FIG. 70. Purge Mode Process Flow Chart

Color Change Mode Process

See FIG. 71, Table 5, and Table 6.

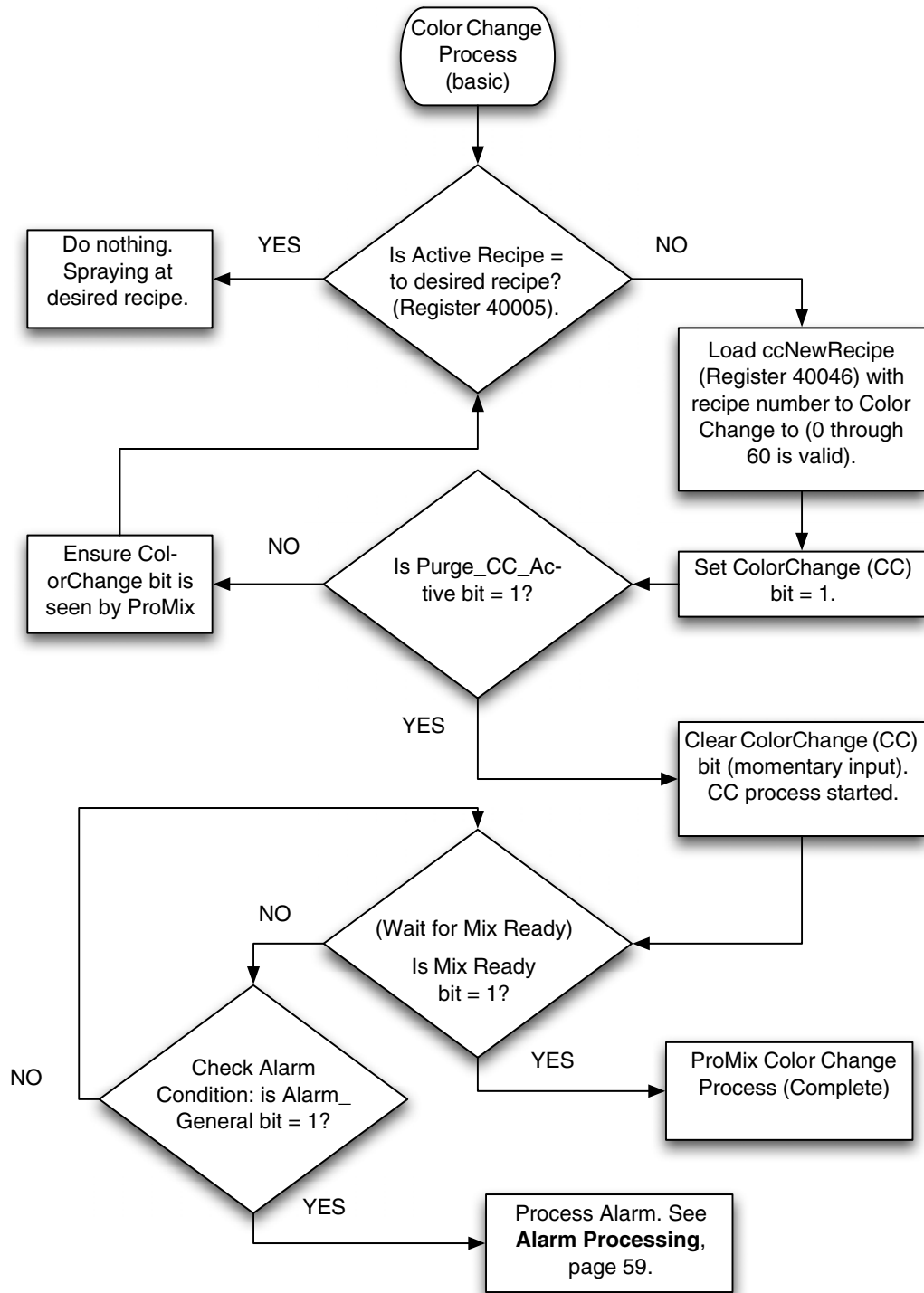

FIG. 71. Color Change Mode Process Flow Chart

Alarm Processing

See FIG. 72, Table 5, Table 6, and Table 7 and Table 8.

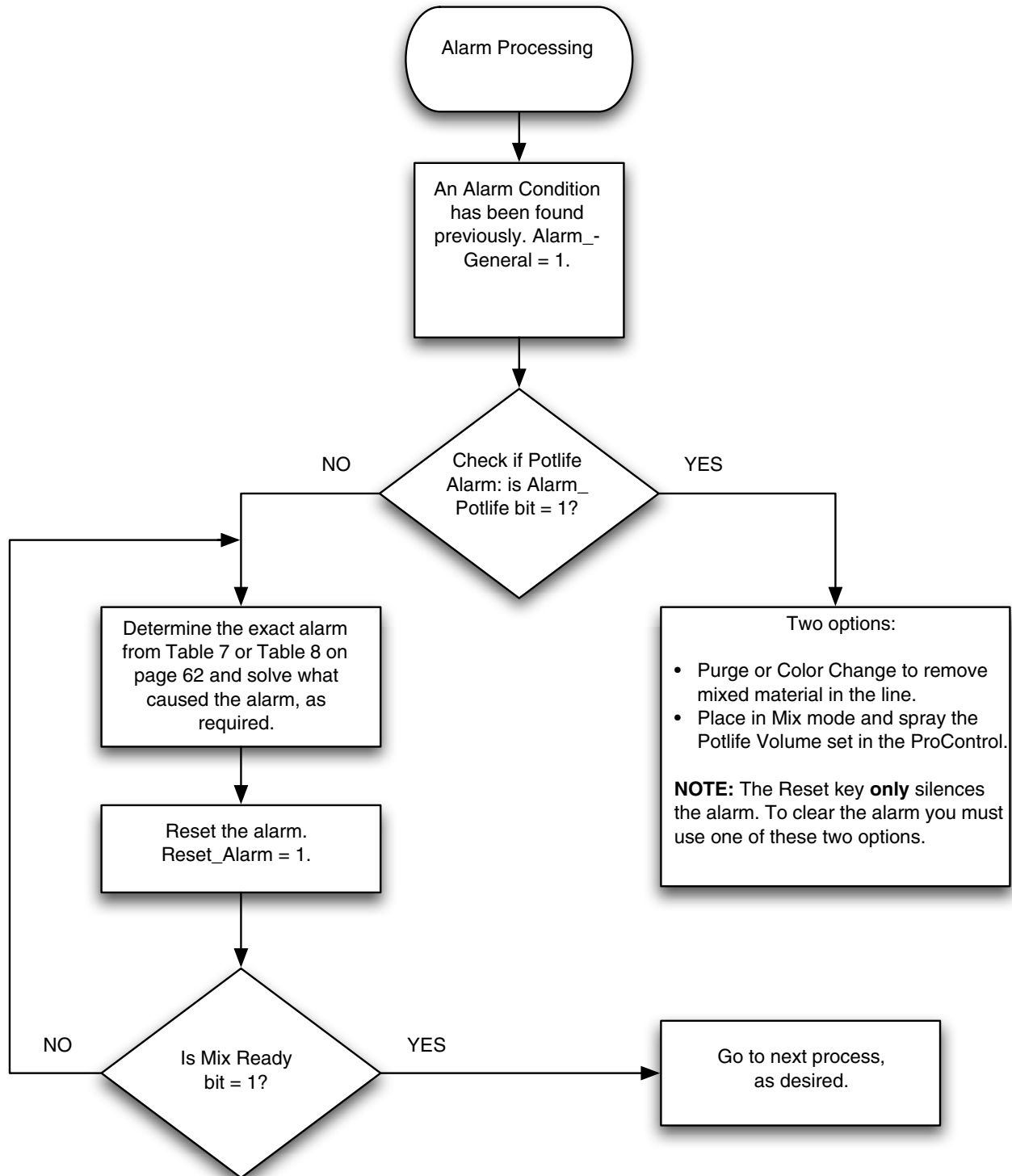

FIG. 72. Alarm Processing Flow Chart

Table 5: ProControl 1KS Digital Inputs (Modbus Register 40040)

Bit	Digital Input Binary	Name	Details
0:5	0 0 0 0 0 0 0 0 0 0 X X X X X X	Recipe	Binary bits for viewing discrete inputs only.
6	0 0 0 0 0 0 0 0 0 1 0 0 0 0 0 0	Color Change (CC)	Set bit to “1” to initiate Color Change (momentary)
7	0 0 0 0 0 0 0 0 1 0 0 0 0 0 0 0	Mix	Set bit initiate Mix mode (maintained)
8	0 0 0 0 0 0 0 1 0 0 0 0 0 0 0 0	Purge	Set bit to “1” to initiate Purge sequence (maintained)
9	0 0 0 0 0 0 1 0 0 0 0 0 0 0 0 0	Job_Complete	Set bit to “1” to initiate Job Complete input (momentary)
10	0 0 0 0 0 1 0 0 0 0 0 0 0 0 0 0	External CC Ready	Set bit to “1” to initiate External Color Change (momentary)
11	0 0 0 0 1 0 0 0 0 0 0 0 0 0 0 0	Solvent Push Enable	Set bit to “1” to initiate Solvent Push
12	0 0 0 1 0 0 0 0 0 0 0 0 0 0 0 0	FC_Calibrate	Set bit to “1” to initiate a Flow Control Calibrate input (momentary)
13	0 0 1 0 0 0 0 0 0 0 0 0 0 0 0 0	Gun_Trigger	Set bit to “1” to indicate the gun is actually triggered (maintain while gun is triggered, remove when gun is closed)
14	0 1 0 0 0 0 0 0 0 0 0 0 0 0 0 0	Reset_Alarm	Set bit to “1” to clear an active Alarm (momentary)
15	1 0 0 0 0 0 0 0 0 0 0 0 0 0 0 0	Remote Stop	Set bit to remotely stop unit (momentary)

NOTE: Shaded cells relate to the flow charts on pages 55-59.

Table 6: ProControl 1KS Digital Outputs (Modbus Register 40041)

Bit	Digital Output Binary	Name	Details
0	0 0 0 0 0 0 0 0 0 0 0 0 0 0 0 1	Purge_CC_Active	"1" indicates Purge or Color Change is in progress
1	0 0 0 0 0 0 0 0 0 0 0 0 0 0 1 0	Mix_Active	"1" indicates Mix is in progress
2	0 0 0 0 0 0 0 0 0 0 0 0 0 1 0 0	Mix_Ready	"1" indicates No Alarms and OK to Mix
3	0 0 0 0 0 0 0 0 0 0 0 0 1 0 0 0	CC_Fill_Active	"1" indicates the Fill portion of a Color Change is in progress
4	0 0 0 0 0 0 0 0 0 0 1 0 0 0 0 0	FCalActive	"1" indicates the Flow Control Calibrate routine is in progress
5	0 0 0 0 0 0 0 0 0 0 1 0 0 0 0 0	Flow_Rate_Alarm	"1" indicates the Flow Rate Alarm/Warning is active
6	0 0 0 0 0 0 0 0 0 1 0 0 0 0 0 0	Special_1	"1" indicates the Special_1 output is on (monitor only)
7	0 0 0 0 0 0 0 0 1 0 0 0 0 0 0 0	Special_2	"1" indicates the Special_2 output is on (monitor only)
8	0 0 0 0 0 0 0 1 0 0 0 0 0 0 0 0	Special_3	"1" indicates the Special_3 output is on (monitor only)
9	0 0 0 0 0 0 1 0 0 0 0 0 0 0 0 0	Special_4	"1" indicates the Special_4 output is on (monitor only)
10	0 0 0 0 0 1 0 0 0 0 0 0 0 0 0 0	GFB_1_Copy	"1" indicates the output for GFB 1 is on
11	0 0 0 0 1 0 0 0 0 0 0 0 0 0 0 0	GFB_2_Copy	"1" indicates the output for GFB 2 is on
12	0 0 0 1 0 0 0 0 0 0 0 0 0 0 0 0	Alarm_General	"1" indicates a General Alarm is in process. (If Mix_Active is still High, then a Warning only.) See the Modbus charts in the Graco Gateway manual 312785 for details on type.
13	0 0 1 0 0 0 0 0 0 0 0 0 0 0 0 0	Alarm_Potlife	"1" indicates a Potlife Alarm is in process.
14	0 1 0 0 0 0 0 0 0 0 0 0 0 0 0 0	AFS_1_Copy	"1" indicates the AFS 1 input to the Fluid Panel is on
15	1 0 0 0 0 0 0 0 0 0 0 0 0 0 0 0	AFS_2_Copy	"1" indicates the AFS 2 input to the Fluid Panel is on

NOTE: Shaded cells relate to the flow charts on pages 55-59.

Table 7: ProControl 1KS Low Word Active Alarms (Modbus Register 40010)

Code	Hex	Binary Code	Name
None	0000	0000 0000 0000 0000	No bits set / no active low-word alarm
E-1	0001	0000 0000 0000 0001	Communication Error Alarm
E-2	0002	0000 0000 0000 0010	Potlife Alarm
E-3	0004	0000 0000 0000 0100	Ratio High Alarm
E-4	0008	0000 0000 0000 1000	Ratio Low Alarm
E-5	0010	0000 0000 0001 0000	Overdose A/B Dose Too Short Alarm
E-6	0020	0000 0000 0010 0000	Overdose B/A Dose Too Short Alarm
E-7	0040	0000 0000 0100 0000	Dose Time A Alarm
E-8	0080	0000 0000 1000 0000	Dose Time B Alarm
E-9	0100	0000 0001 0000 0000	Not used
E-10	0200	0000 0010 0000 0000	Remote Stop Alarm
E-11	0400	0000 0100 0000 0000	Purge Volume Alarm
E-12	0800	0000 1000 0000 0000	CAN Network Communication Error
E-13	1000	0001 0000 0000 0000	High Flow Alarm
E-14	2000	0010 0000 0000 0000	Low Flow Alarm
E-15	4000	0100 0000 0000 0000	System Idle Warning
E-16	8000	1000 0000 0000 0000	Setup Change Warning

Table 8: ProControl 1KS High Word Active Alarms (Modbus Register 40010)

Code	Hex	Binary Code	Name
None	0000	0000 0000 0000 0000	No bits set / no active high-word alarm
E-17	0001	0000 0000 0000 0001	Power On Warning
E-18	0002	0000 0000 0000 0010	Defaults Loaded Warning
E-19	0004	0000 0000 0000 0100	I/O Alarm. See Alarm Troubleshooting , page 119
E-20	0008	0000 0000 0000 1000	Purge Initiate Alarm
E-21	0010	0000 0000 0001 0000	Material Fill Alarm
E-22	0020	0000 0000 0010 0000	Tank A Low Alarm
E-23	0040	0000 0000 0100 0000	Tank B Low Alarm
E-24	0080	0000 0000 1000 0000	Tank S Low Alarm
E-25	0100	0000 0001 0000 0000	Auto Dump Complete Alarm
E-26	0200	0000 0010 0000 0000	Color/Catalyst Purge Alarm
E-27	0400	0000 0100 0000 0000	Color/Catalyst Fill Alarm
E-28	0800	0000 1000 0000 0000	Material Advance Complete
E-29	1000	0001 0000 0000 0000	Tank C Low Alarm
E-30	2000	0010 0000 0000 0000	Overdose C Alarm
E-31	4000	0100 0000 0000 0000	Dose Time C Alarm
E-32	8000	1000 0000 0000 0000	Audible Buzzer Active

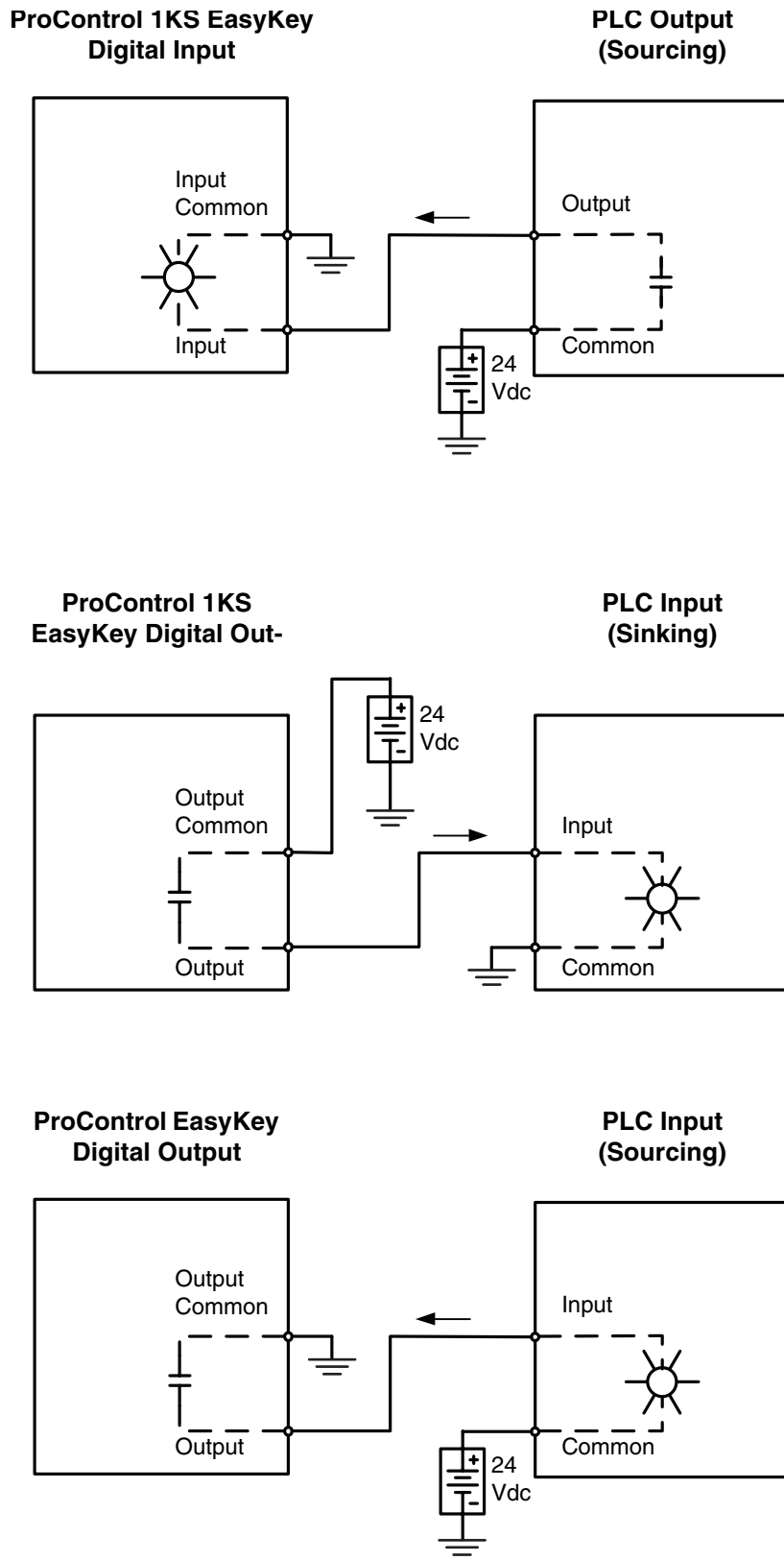

FIG. 73. Automation 24 Vdc Sourcing Input Diagram

Table 9: Discrete I/O Terminal Connections

Pin	Port	Name	Details (also see pages 60 and 61)
Digital Inputs to Remote I/O Board for Proportioning			
1	J2	Mix	Set Bit to Initiate Mix Mode (maintain)
2	J2	Purge	Set Bit to "1" to initiate Purge Sequence (maintained)
3	J2	Job_Complete	Set Bit to "1" to initiate Job Complete Input (momentary)
4	J2	External CC Ready	Set Bit to "1" to initiate External Color Change (maintained)
5	J2	Solvent Push Enable	Set Bit to "1" to initiate Solvent Push
6*	J2	Digital Input Common	Set Binary Bits for Recipe to Change To (hold until changing again)
Digital Inputs to Remote I/O Board for Color Change			
1*	J3	Digital Input Common	
2	J3	Recipe Bit 0	Set Binary Bits for Recipe to Change To (hold until changing again)
3	J3	Recipe Bit 1	Set Binary Bits for Recipe to Change To (hold until changing again)
4	J3	Recipe Bit 2	Set Binary Bits for Recipe to Change To (hold until changing again)
5	J3	Recipe Bit 3	Set Binary Bits for Recipe to Change To (hold until changing again)
6	J3	Recipe Bit 4	Set Binary Bits for Recipe to Change To (hold until changing again)
7	J3	Recipe Bit 5	Set Binary Bits for Recipe to Change To (hold until changing again)
8	J3	Color Change (CC)	Set Bit to "1" to initiate Color Change (momentary)
Digital Inputs to EasyKey 10-Pin Terminal Block for Gun Trigger and Alarm Processing			
1	J5	Flow Control Calibrate	Set Bit to "1" to initiate Flow Control Calibrate (momentary)
2	J5	Gun Trigger	Set Bit to "1" to indicate Gun is Triggered (fluid flow expected)
3†	J5	Digital Input Common	
4	J5	Remote Stop	Set Bit to "1" to initiate a Remote Stop (momentary)
5	J5	Reset_Alarm	Set Bit to "1" to Clear an Active Alarm (momentary)

* Digital inputs tied together on the I/O board (see FIG. 67).

† Digital inputs tied together on the EasyKey Display Board.

Multiple connection points for convenience.

Table 9: Discrete I/O Terminal Connections (Continued)

Pin	Port	Name	Details (also see pages 60 and 61)
Digital Outputs from Remote I/O Board for Proportioning			
1★	J4	Digital Output Common/Power	
2	J4	Purge CC Active	"1" Indicates Purge or Color Change is in progress
3	J4	Mix Active	"1" Indicates Mix is in progress
4	J4	Mix Ready	"1" Indicates No Alarms and OK to Mix
5	J4	CC Fill Active	"1" Indicates the Fill Portion of a Color Change is in progress
6	J4	FC Cal Active	"1" Indicates the Flow Control Calibrate routine is in progress
7	J4	Flow Rate	"1" Indicates the Flow Rate Alarm/Warning is active
8★	J4	Digital Output Common/Power	
Digital Outputs from Remote I/O Board for Special Outputs			
1★	J5	Digital Output Common/Power	
2	J5	Special_1	"1" Indicates the Special_1 Output is on
3	J5	Special_2	"1" Indicates the Special_2 Output is on
4	J5	Special_3	"1" Indicates the Special_3 Output is on
5	J5	Special_4	"1" Indicates the Special_4 Output is on
6★	J5	Digital Output Common/Power	
Digital Outputs from EasyKey 10-Pin Terminal Block for Alarm and Potlife Indication			
6	J5	General Alarm Output	"1" Indicates the General Alarm Output is on
7◆	J5	Digital Output Common/Power	
8	J5	Potlife Alarm	"1" Indicates the Potlife Alarm Output is on
Analog Input to EasyKey 10-Pin Terminal Block for Flow Rate Set Point			
9	J5	Flow Rate Analog In (0-10 VDC)	0 - 10VDC input for Flow Setpoint relative to flow range set in 2KS Flow Range Screen
10	J5	Flow Rate Common to Pin 9	Common side of Flow Setpoint from Terminal 9
Modbus Network Communications on EasyKey 6-Pin Terminal Block			
1	J10	RS485 Integration A	Communication to External PLC/Controller
2	J10	RS485 Integration B	
3	J10	RS485 Integration Shield/Ground	
4	J10	RS485 Network A	Not used
5	J10	RS485 Network B	
6	J10	RS485 Network Shield/Ground	

★ Digital outputs tied together on the I/O board (see FIG. 67).

◆ Digital outputs tied together on the EasyKey Display Board.

Multiple connection points for convenience.

Modbus and I/O Data

See Table 10 and Table 11 for Modbus register addresses and input/output data.

Reference the Discrete I/O listing of all the inputs and outputs (see page 67). Ensure these are fully understood. The same implementation used for Discrete I/O is used for the Network communication protocol.

For example: The Gun Trigger Input will now be a specific bit of Modbus Register 40040. Monitoring of Modbus Register 40041 for specific output status conditions will be required as explained in the Discrete I/O section of the ProControl 1KS Operation manual. The PLC will have to read the various bits, and in some cases (40040 and 40041 for example) must mask out the various bit positions to determine each of the separate input and output statuses. This requires experience and should not be done on the job site. A full understanding of the color change process as well as the required timing of various inputs and outputs is required.

NOTE: Analog input for flow control set point will now be a dedicated Modbus register. Register 40137 will require the specific flow rate (i.e. 125 cc/min). This is not a voltage reading but the actual flow target.

Start Mix Process

See FIG. 68, Table 5, and Table 6.

1. Verify that the Mix Ready bit (bit 2 of 40041) is on.
2. Turn on the Mix bit (bit 7 of 40040).
3. Verify that the Mix Active bit (bit 1 of 40041) is on, to ensure that the Mix request was received.

Stop Mix Process

See FIG. 69, Table 5, and Table 6.

1. Clear the Mix bit.
2. The Mix Active output should clear and Mix Ready should now be set.

NOTE: The ProControl 1KS will automatically go into Idle mode after 2 minutes of inactivity. A general alarm will be present and Mix Active will remain High. The Alarm bit (40010) will indicate the system Idle alarm. When a new Gun Trigger input is seen, the ProControl 1KS will resume mixing material where it left off. Do not

toggle the Mix bit; doing so restarts the Mix process from the beginning.

Color Change Process

See FIG. 71, Table 5, and Table 6.

1. Verify that Mix Ready is set. This ensures that there are no alarms and that the system is ready for the next command.
2. Load ccNewRecipe (Modbus 40046) with a recipe number to color change to.
3. Set color change (40040 bit 6).
4. Verify that Purge_CC_Active is seen (40041 bit 0).
5. Clear color change bit (momentary only).
6. **Do not** change the ccNewRecipe value until a new recipe change is requested.
7. The color change process will stop automatically as programmed. Monitor Purge_CC_Active bit for completion.

Purge Process

See FIG. 70, Table 5, and Table 6.

1. Verify that Mix Ready is set. This ensures that there are no alarms and that the system is ready for the next command.
2. Set purge (40040 bit 8).
3. Verify that Purge_CC_Active is seen (40041 bit 0).
4. When Purge_CC_Active bit clears, clear Purge_Start bit. Clearing this bit in the middle of a purge sequence will abort the purge sequence.

NOTE: It only requires three Modbus registers to provide full communications from the PLC to the ProControl 1KS. All other registers are on a need to view and monitor basis.

40040 Robot Digital In (Send/Edit Values in ProControl 1KS)
 40041 Robot Digital Out (READ ONLY - Active values)
 40046 Go To Recipe value for next ProControl 1KS recipe

Table 10: ProControl 1KS Modbus/TCP Variable Map

* Read/Write Status	EasyKey Modbus Register	Description	Size	Units	Low Limit	High Limit
Read Only	40003	Current flow rate	16 Bit	cc/min	0	5000
Read Only	40004	Actual ratio	16 Bit	none	0	9999
Read Only	40005	Active recipe	16 Bit	none	0	60
Read Only	40006	Potlife 1 remaining	16 Bit	sec	0	9999
Read/Write	40007	Job complete	16 Bit	none	0	0xFFFF
Read/Write	40008	Reset job total	16 Bit	none	0	9
Read Only	40009	Potlife 2 remaining	16 Bit	sec	0	9999
Read Only	40010	Active fault	32 Bit	none	0	0xFFFF FFFF
Read Only	40032	Control version	32 Bit	none	0	0xFFFF FFFF
Read/Write	40040	Robot digital input	16 Bit	none	0x0000	0xFFFF
Read Only	40041	Robot digital output	16 Bit	none	0x0000	0xFFFF
Read/Write	40046	CC New recipe	16 Bit	none	0	60
Read Only	40048	Current fluid pressure	16 Bit	1/100 psi	0	50000
Read Only	40049	V/P percent output	16 Bit	%	0	100
Read Only	**40056	Actual ratio reducer	16 Bit	none	0	9999
Read Only	40114	Flow control option	16 Bit	0=proportioning only 1=1K flow control (future) 2=2K flow control 3=pressure override 4=manual pct. override	0	4
Read/Write	40115	Flow setpoint data source	16 Bit	0=discrete 1=network	0	1
Read/Write	40120	Manual override pct. drive	16 Bit	%	0	100
Read/Write	40125	***FC range	16 Bit	0=0-300 cc/min 1=0-600 cc/min 2=0-1200 cc/min	0	2
Read/Write	40126	FC tolerance	16 Bit	%	0	99
Read/Write	40127	FC proportional gain Kp	16 Bit	default=400	0	9999
Read/Write	40128	FC integral gain Ki	16 Bit	default=40	0	9999
Read/Write	40129	FC alarm time	16 Bit	sec	0	99
Read/Write	40137	FC setpoint	16 Bit	cc/min	0	1200
Read/Write	40159	FC Learn Strength	16 Bit	%	0	100
Read/Write	40171	FC Learn Threshold	16 Bit	cc/min	0	1200
Read/Write	43123	FC override mode	16 Bit	0=off (normal) 1=% open 2=pressure mode	0	2
Read/Write	43141	FC enable	16 Bit	0=off 1=on	0	1

* This column represents the rule that must be implemented by automation. Writing to Read Only registers must be avoided.

**For ProMix 3KS Systems only.

***Flow Control

Table 11: ProControl 1KS Recipe Bits

Recipe Bits						Number	Recipe Bits						Number
5	4	3	2	1	0		5	4	3	2	1	0	
0	0	0	0	0	0	0	1	0	0	0	0	1	33
0	0	0	0	0	1	1	1	0	0	0	1	0	34
0	0	0	0	1	0	2	1	0	0	0	1	1	35
0	0	0	0	1	1	3	1	0	0	1	0	0	36
0	0	0	1	0	0	4	1	0	0	1	0	1	37
0	0	0	1	0	1	5	1	0	0	1	1	0	38
0	0	0	1	1	0	6	1	0	0	1	1	1	39
0	0	0	1	1	1	7	1	0	1	0	0	0	40
0	0	1	0	0	0	8	1	0	1	0	0	1	41
0	0	1	0	0	1	9	1	0	1	0	1	0	42
0	0	1	0	1	0	10	1	0	1	0	1	1	43
0	0	1	0	1	1	11	1	0	1	1	0	0	44
0	0	1	1	0	0	12	1	0	1	1	0	1	45
0	0	1	1	0	1	13	1	0	1	1	1	0	46
0	0	1	1	1	0	14	1	0	1	1	1	1	47
0	0	1	1	1	1	15	1	1	0	0	0	0	48
0	1	0	0	0	0	16	1	1	0	0	0	1	49
0	1	0	0	0	1	17	1	1	0	0	1	0	50
0	1	0	0	1	0	18	1	1	0	0	1	1	51
0	1	0	0	1	1	19	1	1	0	1	0	0	52
0	1	0	1	0	0	20	1	1	0	1	0	1	53
0	1	0	1	0	1	21	1	1	0	1	1	0	54
0	1	0	1	1	0	22	1	1	0	1	1	1	55
0	1	0	1	1	1	23	1	1	1	0	0	0	56
0	1	1	0	0	0	24	1	1	1	0	0	1	57
0	1	1	0	0	1	25	1	1	1	0	1	0	58
0	1	1	0	1	0	26	1	1	1	0	1	1	59
0	1	1	0	1	1	27	1	1	1	1	0	0	60
0	1	1	1	0	0	28							
0	1	1	1	0	1	29							
0	1	1	1	1	0	30							
0	1	1	1	1	1	31							
1	0	0	0	0	0	32							

Typical PLC Interaction with ProControl 1KS

This section describes a typical interaction when a local PLC is directly connected to the Discrete I/O connections of the ProControl 1KS.

See **ProControl Integration Specifics** on page 49 for a detailed explanation of inputs and outputs.

NOTE: Communications fields of **Configure Screen 6** must be set to DISCRETE (see page 31).

Start Mixing

To start the mix process, the PLC will monitor and ensure the Mix_Ready output is High. This provides assurance it is ready to mix. PLC will drive High the Mix_Start input, keep it High and monitor the Mix_Active output to ensure the ProControl 1KS followed through on the request.

Stop Mixing

To stop mixing (to perform a purge or color change), remove the Mix_Start input (the status bar on the EasyKey will show STANDBY). Monitor the Mix_Ready output to ensure the Mix_Active output goes Low.

Color Change

To perform a color change, ensure there are no alarms (except the Potlife Alarm). If alarms are present, the Alarm_Reset input should be sent momentarily to clear the alarm (>100 msec).

NOTE: Alarm_Reset will not reset a Potlife alarm. Only dispensing the Potlife Volume or a complete Purge/Color Change will reset a Potlife alarm.

The Alarm Reset Input will silence the audible alarm. Turn the Color_Change_Start input on momentarily (>100 msec) while the proper sequence of recipe bits are set.

NOTE: The Recipe Bits must be presented at least 100 msec before the Color Change Start input is turned on and remain until a new recipe is required.

During the short On state, the recipe will be read from this binary sequence and the status bar of the EasyKey will display COLOR CHANGE XX. The Purge_CC_Active output will be High for the duration of the color change purge process. During the Mixed Material Load portion at the end of the Color Change sequence, the Fill_Active output will be on, indicating that portion of the color change. These will not be on at the same time. Once the Mix_Ready output goes High with no alarms, then the PLC has assurance that the requested color change has taken place with the requested recipe being the current active recipe. If any error occurs during the process, the requested recipe will not be loaded, and the old recipe will remain active.

NOTE: It is not possible to read the active recipe through Discrete I/O alone. Only by monitoring networked registers through the Gateway is it possible to view the active recipe. Proper management of the alarm status outputs during the color change process will ensure the active recipe is what is expected.

Purge

To start a Purge (no color change), drive the Purge_Start input High (maintained) while ensuring Mix_Ready output is High (ensuring no active alarms). An exception is Potlife alarm (see **Color Change** above if alarms are present.) The Purge_CC_Active output is High for the entire Purge process. Ensure there are no alarms during this process. Fill_Active is High when Mix is on. When complete, Mix_Ready output will be High, indicating a completed purge.

NOTE: No change is made to the active recipe.

Gun Trigger Input

This input is sent and expected every time the gun is actually triggered, and this input is turned off when the gun is not triggered. Never tie this input with any other signal. Without this input, some critical mixing alarms are eliminated.

IMPORTANT: This input **must** be provided through Discrete I/O for integrated flow control applications, to ensure fast coordination with the flow control process. Applications without flow control can use Gun Trigger input through Network Communications or Discrete I/O.

NOTE: The Gun Trigger input has the same effect as the air flow switch used on manual ProControl 1KS systems.

Alarm Monitoring/Reset (Discrete I/O)

Anytime an alarm occurs, the Alarm Reset input will reset the alarms and allow for processing of the next step by automation, **except for the following conditions:**

- Potlife Alarms **cannot** be reset by the Alarm Reset input or through the EasyKey Alarm Reset  key. Only a Purge/Color Change or spraying the Potlife volume will reset a Potlife alarm. (See Alarm_Potlife output information on page 54.)
- When Flow Control is turned on (see **Configure Screen 5** on page 30), the Flow_Rate_Alarm output will be High when the instantaneous flow rate is above or below the Flow Rate tolerance setting. (High Flow or Low Flow will be the condition, indicating in the status bar of the EasyKey.) This output will be High along with the Mix_Active output. The PLC should monitor the amount of time this condition exists and take action at a predetermined time. With Flow Control there will be times (for example during flow rate changes) where the general alarm as described here will be High (typically momentarily). The PLC must read this Alarm output (i.e. general alarm), see if Mix_Active is still High, and if so, start a timer. A typical example would be to ensure all parts are sprayed within a specific flow rate range. A maximum predetermined time would be set to allow a Low or High flow condition to exist continuously.
- Shutdown or go to Standby after the flow rate alarm time expires.

Job_Complete Input

Every time a momentary Job_Complete input is seen by the ProControl 1KS, a job log will be recorded, logging the A and B meter volumes (cc) with a time and date stamp. The volumes will then be reset to 0. (Volume totals are accumulated since the last reset.)

NOTE: A Color Change accomplishes the same Job Complete Reset functions. The Job_Complete input is commonly used to record material usage for a specific set of parts. These volumes are sprayed material volumes.

For Applications with Dump Valves (for quick purges/color changes at or near the gun):

ProControl 1KS has four specials that can each be turned off and on twice throughout a color change sequence. See **Advanced Setup Screen 8** on page 39 or **Recipe Setup Screen 7** on page 44.

For example, a dump valve at a gun on a robot could be opened at the appropriate times to facilitate fast color changes. Another output could be used to automatically drive an air-operated fluid regulator High during the Purge or Color Change process.

NOTE: With integrated Flow Control, the flow control regulator automatically is driven High. See **Advanced Setup Screen 5** on page 37 for specifics on setting up these values. Each of the specials can be monitored, but can only be controlled through the times entered within the setup screens of the EasyKey or by managing the proper registers on the network.

The following ProControl 1KS inputs should **never** be on (High) at the same time:

- Mix_Start
- Purge_Start
- Color_Change_Start

The Recipe Bits (0-6) are always on at the same time. The only time these bits are recognized is when the Color_Change_Start input is High. The Recipe Bits should be loaded and **stay loaded** for the current recipe. Do not change the Recipe Bits until a color change is required again. Inconsistent results are possible if this is not followed.

Integration Timing Charts

Refer to FIG. 74 - FIG. 80 for integration timing charts.

ProMix Integrated Automation Control X to Y
 Recipe Change
 External Color Change Not Enabled

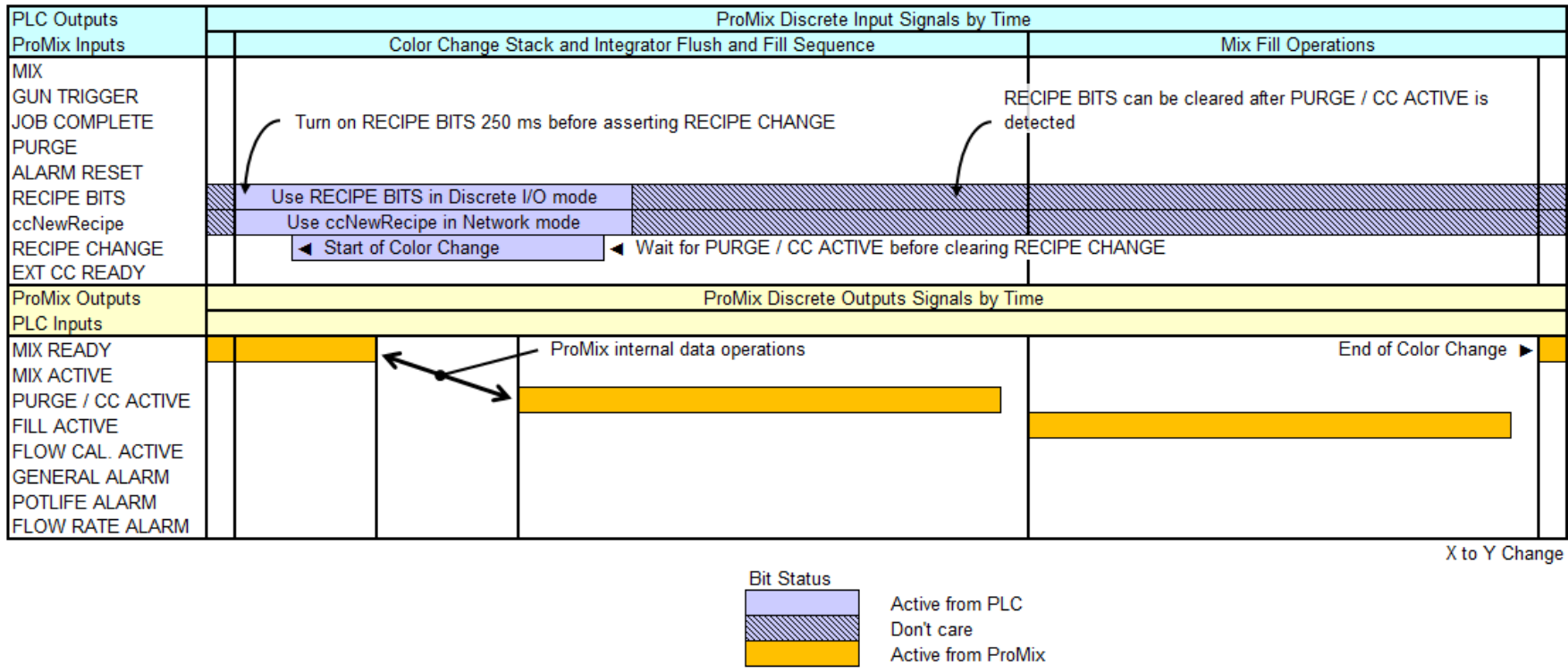

FIG. 74. Integration Control Recipe Change X to Y

ProMix Integrated Automation Control X to Y
 Recipe Change
 External Color Change Enabled

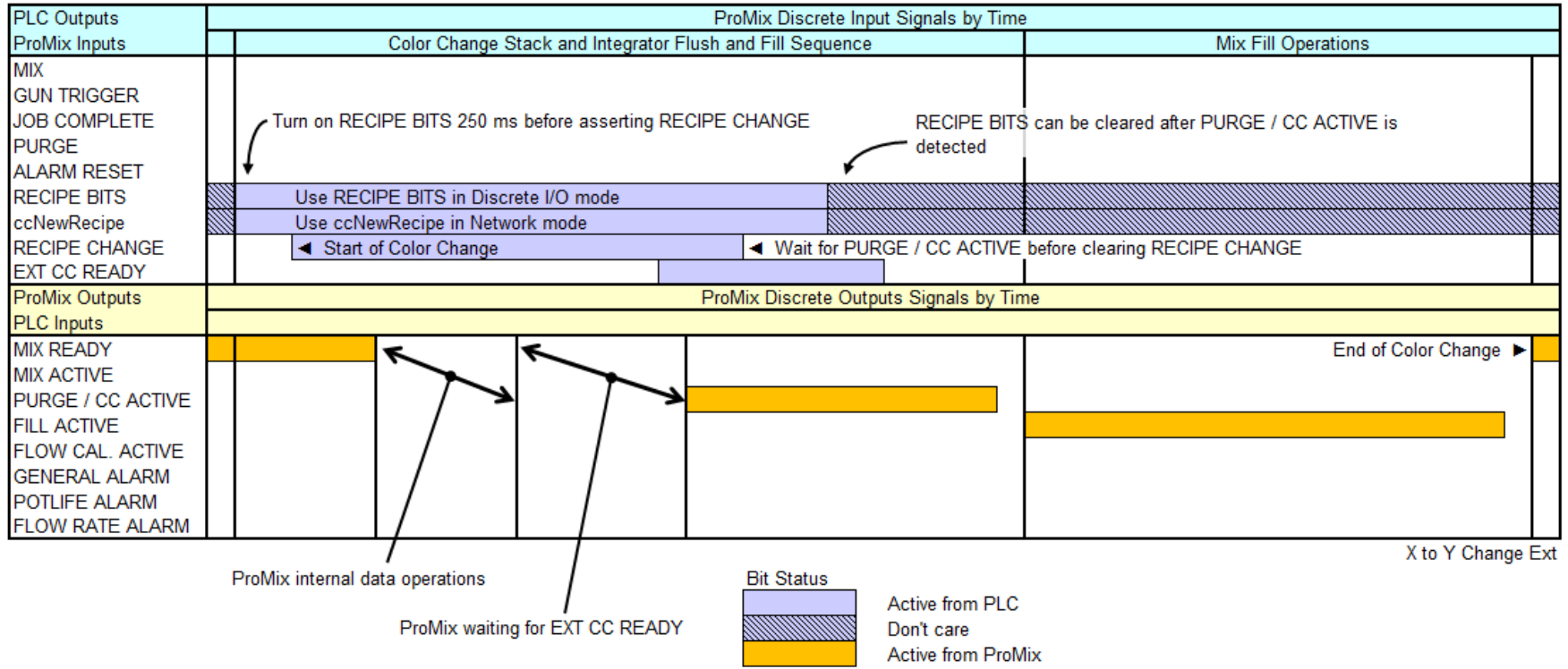

FIG. 75. Integration Control Recipe Change X to Y External Color Change

ProMix Integrated Automation Control Y to Y
Y Purge

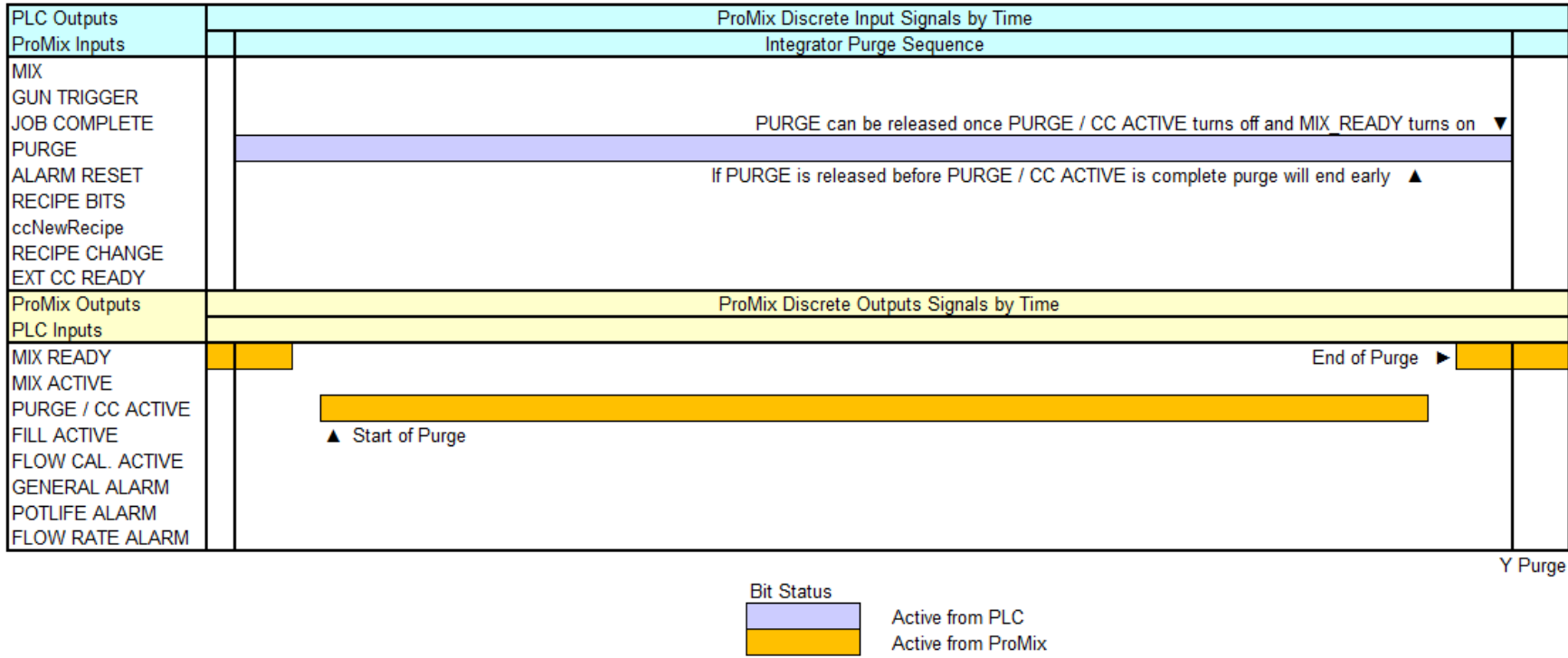

FIG. 76. Integration Control Y Purge

ProMix Integrated Automation Control Y to Y
Y Fill

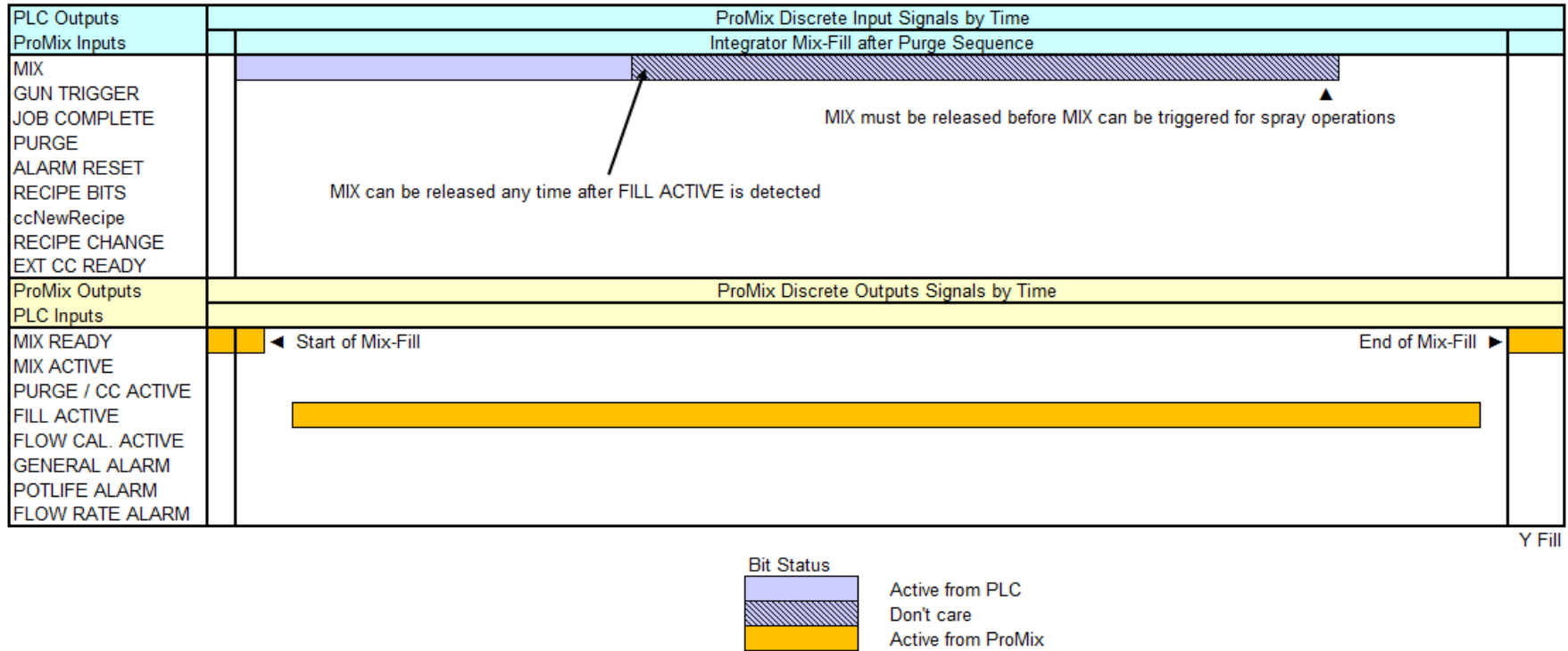
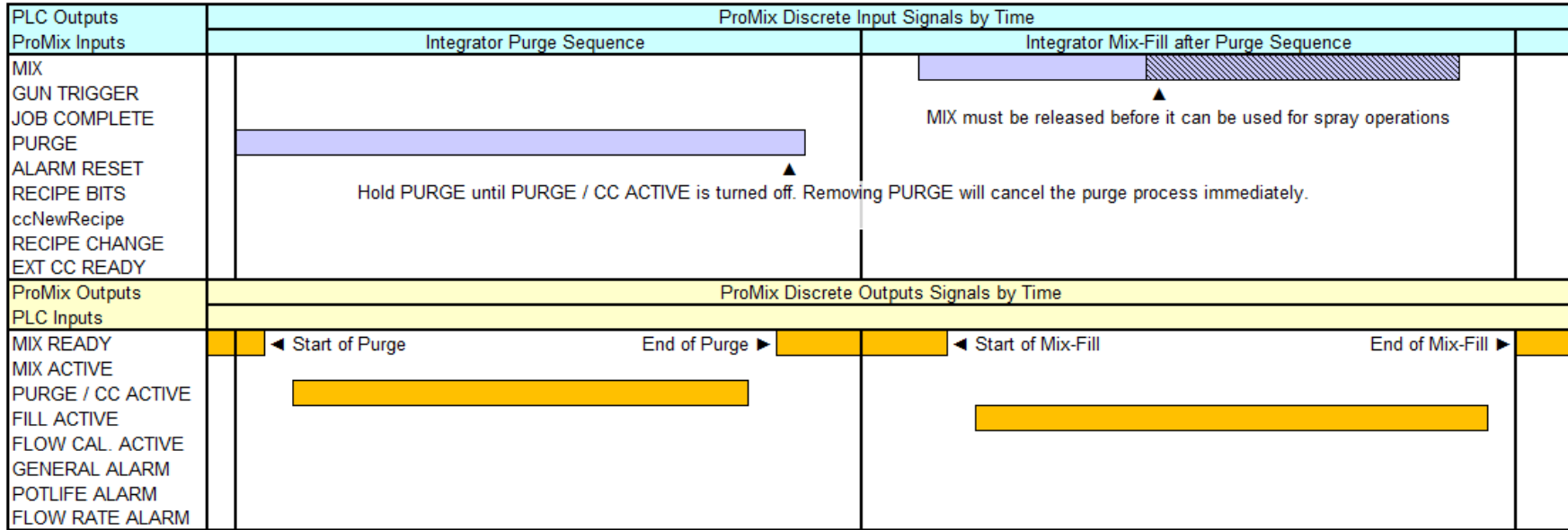

FIG. 77. Integration Control Y Fill

ProMix Integrated Automation Control Y to Y
Y Purge and Fill



Y Purge and Fill



FIG. 78. Integration Control Y Purge and Fill

ProMix Integrated Automation Control Y to Y
Mix Sequences

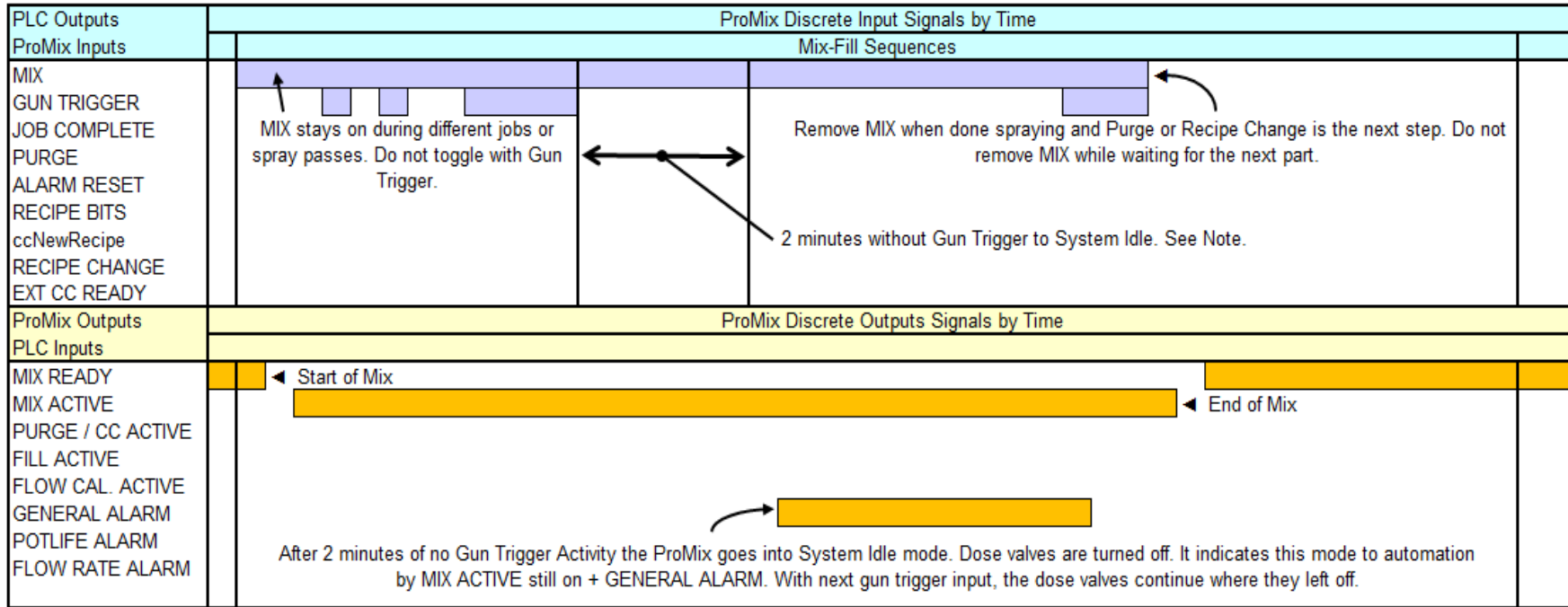

Mix Sequences

Bit Status
 Active from PLC
 Active from ProMix

Note: The System Idle time can be set from 2 minutes to 99 minutes in Configure Screen 4 for systems in Automatic or Semi-Automatic mode.

FIG. 79. Integration Control Mix Sequences

ProMix Integrated Automation Control Y to Y
Alarm Processing

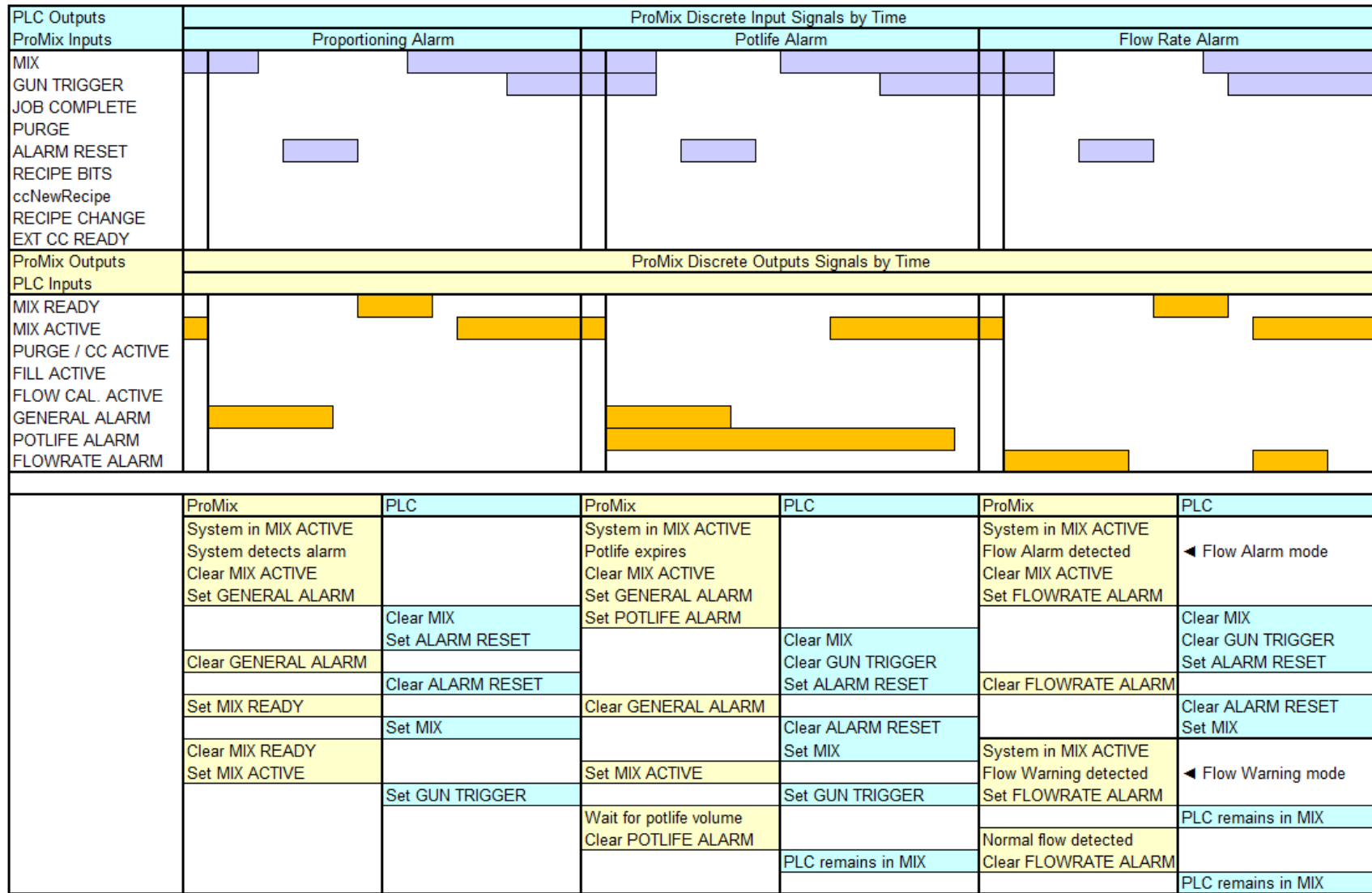

Bit Status

 Active from PLC
 Active from ProMix

Alarm Processing

FIG. 80. Integration Control Alarm Processing

Integrated Flow Control

Flow Control Description

Flow control is an optional feature which incorporates an intrinsically safe regulator control module with the Pro-Control 1KS automatic system. Flow control precisely regulates the flow of material to a manual or automatic air spray gun, to help ensure adequate coverage and avoid sags or runs in the finish coat.

NOTE: Flow control cannot be selected with dynamic dosing. It is not for use with air-assisted or airless spray guns.

Flow control uses the existing flow meters in a wall mounted fluid station or a RoboMix fluid station. There is no flow meter in the mixed material line.

Flow Control Components

249849 Flow Control Module

See FIG. 81. The 249849 Flow Control Module includes an air-operated fluid pressure regulator, fluid pressure sensor, voltage to air pressure valve, and circuit board. See manual 3A2097. The function of this unit is to receive the flow analog signal and drive (manage) the desired flow rate.

24H989 Flow Control Module

See FIG. 82. The 24H989 Flow Control Module is for use with a user-supplied, remotely mounted, air-operated fluid pressure regulator. The module includes a remote fluid pressure sensor and connecting cable, voltage to air pressure valve, and circuit board. See manual 3A2097. The function of this unit is to receive the flow analog signal and drive (manage) the desired flow rate.

NOTE: For best results, place the supplied pressure sensor as close to the remote fluid regulator as possible.

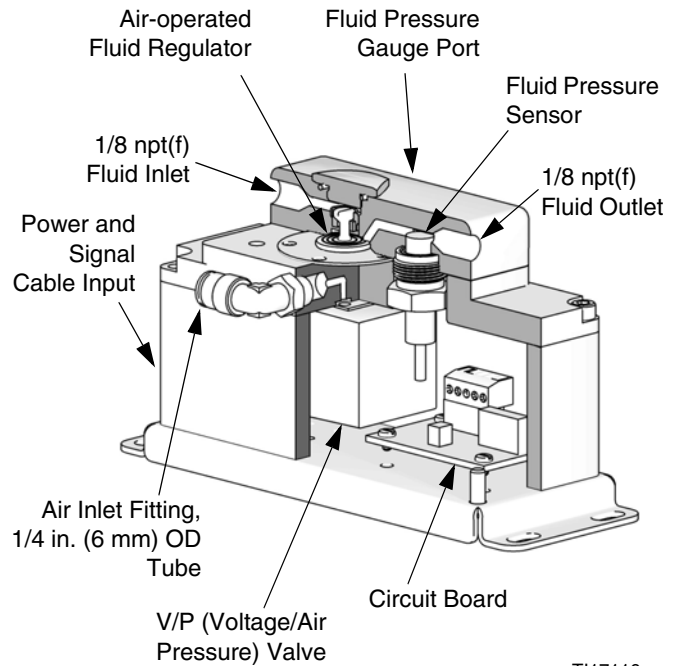

TI17116a

FIG. 81. Cutaway of 249849 Flow Control Module

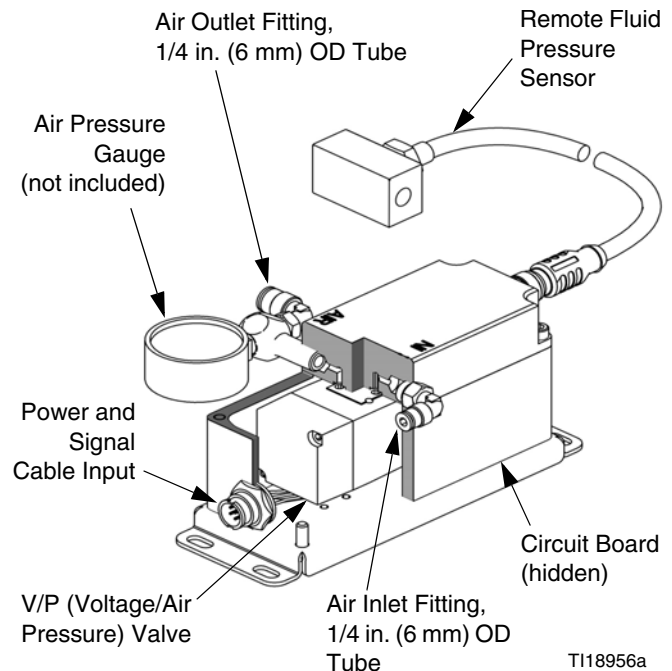

TI18956a

FIG. 82. Cutaway of 24H989 Flow Control Module

Fluid and Air Pressure Requirements

The fluid input pressure to the fluid regulator must be high enough to provide a 15-20 psi (0.1-0.14 MPa, 1.0-1.4 bar) pressure differential across the regulator at the highest flow setting. *For example*, if the maximum flow rate set point is 280 cc/min and 35 psi outlet pressure is required to achieve that flow, the input pressure must be 50-55 psi.

Required air pressure to the flow control module is 70-100 psi (0.35-0.7 MPa, 3.5-7.0 bar).

NOTE:

- For flow control modules 249849 and 24H989 used with a 1:1 fluid regulator, the fluid outlet pressure from the regulator must be between 5-75 psi (0.034-0.52 MPa, 0.34-5.2 bar) for all flow set points. *Flow rate set points with pressures outside this range are not achievable. There must be at least 5 psi (0.034 MPa, 0.34 bar) fluid pressure at the lowest flow rate.*
- If flow control module 24H989 is used with a fluid regulator at a ratio greater than 1:1, the relationship of air pressure to fluid outlet pressure is very important. The lowest recommended air pressure from the V/P is 5 psi (0.034 MPa, 0.34 bar). *Back pressure may be required to ensure minimal fluid pressure at the lowest flow rate setpoint.*

The turn down ratio of the typical fluid regulator is approximately 3:1 or 4:1, depending on material type and viscosity. *For example*, if the lowest flow rate required is 100 cc/min, the top flow rate achievable may be 300-400 cc/min.

NOTE: The top flow rate is **not** the maximum flow rate range selected.

Flow Control Operation

See FIG. 83 for module 249849 and FIG. 84 for module 24H989. The Flow Control System includes two information loops:

- The **pressure loop** monitors fluid pressure with the pressure sensor in the module. This allows the system to react very quickly to set point changes.

While the gun is not triggered the system still drives to the pressure determined from the data table from the flow rate set point. This pressure drive will operate for the amount of time set in the “GT-Off drive time” value in the Advanced Screen. This screen can be accessed and the setting modified while Flow Control is set to “On: Setup” in **Configure Screen 5**, page 30.

The target pressure when the gun trigger is off can be adjusted using the “GT-Off target rise” value in the **Advanced Setup Screen 7**, page 38. This amount is added to the value from the data table. This may compensate for the immediate pressure drop at the gun when the gun trigger is opened. Adjust for gun triggers at the lowest flow rates.

- The **flow loop** monitors fluid flow through flow meter pulses, ensuring accuracy. The gun must be triggered during the flow loop.

The Flow Control System creates a data table that targets a desired flow rate based on the fluid pressure. It then monitors the flow loop to maintain the flow rate.

The data table update performance can be modified using the “Learn Strength” value in **Advanced Setup Screen 6**, page 38. This determines how much of the instantaneous flow error value is applied when updating the table. High values make it learn more quickly, but may lead to oscillation. Low values make it learn more slowly, but may make adjustment times unacceptable.

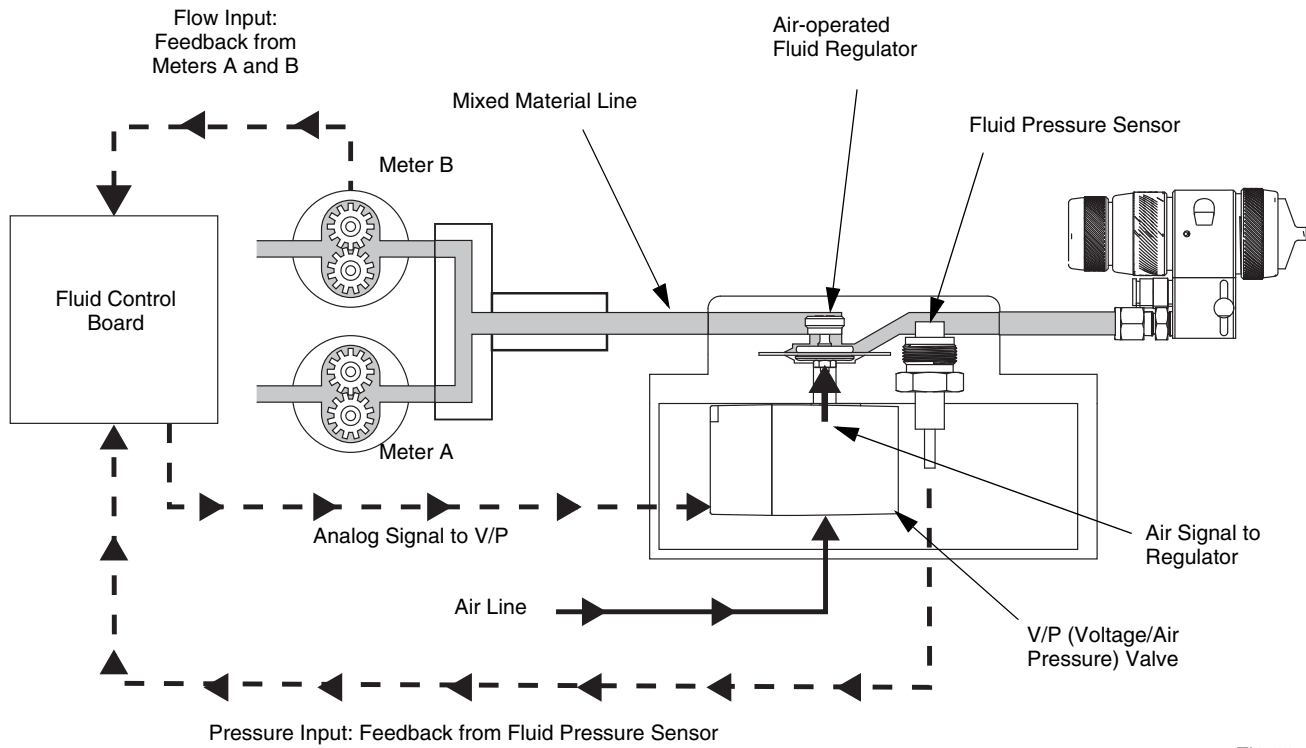

TI17118a

FIG. 83. ProControl 1KS Flow Control Schematic Diagram (249849 Module)

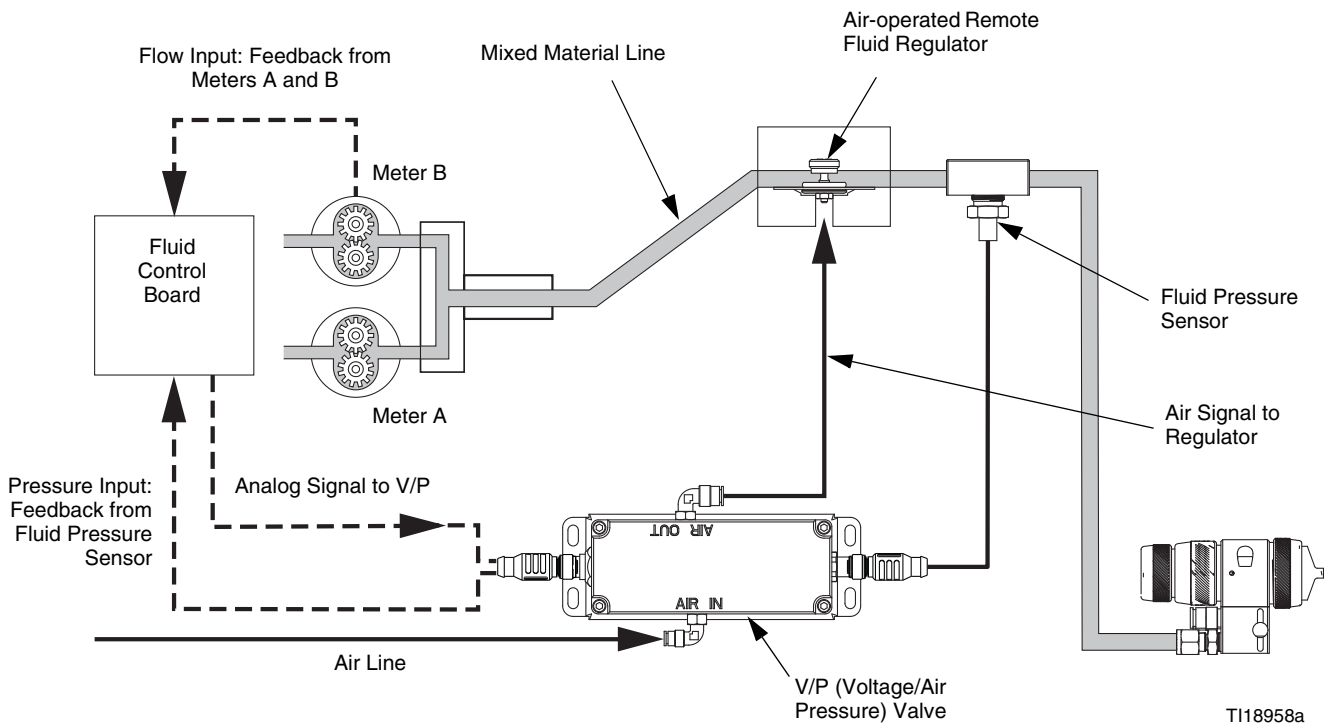

TI18958a

FIG. 84. ProControl 1KS Flow Control Schematic Diagram (24H989 Module)

Flow Control Operating Process Example

Operating Ranges

Flow Control operating ranges correlate the desired flow rate to the incoming flow set point signal (see below).

The operating ranges are:

- 0-300 cc/min
- 0-600 cc/min
- 0-1200 cc/min
- 0-100% (% open in manual override mode)

In this example, the range is set to 0-300 cc/min and the target flow rate is 150 cc/min.

Step 1: Flow Set Point Input Signal

Discrete Input

A discrete signal is 0-10Vdc, which corresponds linearly to the set operating range. For example, if the set range is 0-300 cc/min and the desired flow rate is 150 cc/min, the ProControl 1KS receives a flow rate setpoint (5Vdc signal) from the PLC or robot.

Network Communication Input

A network communication signal is either the desired flow rate (150 cc/min in this example) or the % open.

Step 2: Pressure Loop

NOTE: The gun must be triggered during the pressure loop.

See FIG. 85 for module 249849 and FIG. 86 for module 24H989. The ProControl 1KS drives the system to the necessary pressure to meet the desired flow rate (150 cc/min). The pressure sensor in the module verifies the actual pressure and returns the reading back to the ProControl 1KS.

Step 3: Flow Loop

NOTE: The gun must be triggered during the flow loop.

The flow meters verify that the target flow rate is achieved and feeds this information back to the ProControl 1KS. The ProControl 1KS adjusts the voltage to the V/P to maintain the actual flow.

Step 2 and Step 3 repeat continuously to maintain pressure and flow.

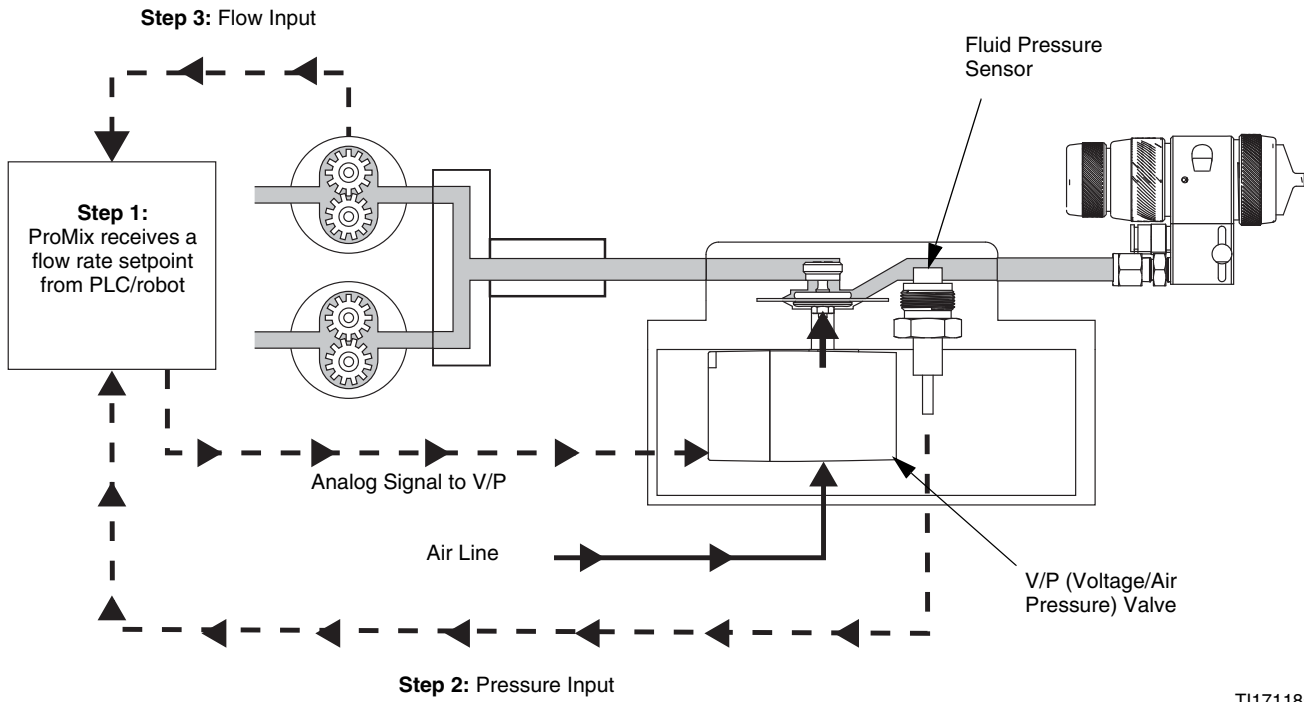

TI17118a

FIG. 85. ProControl 1KS Flow Control Pressure Loop and Flow Loop (249849 Module)

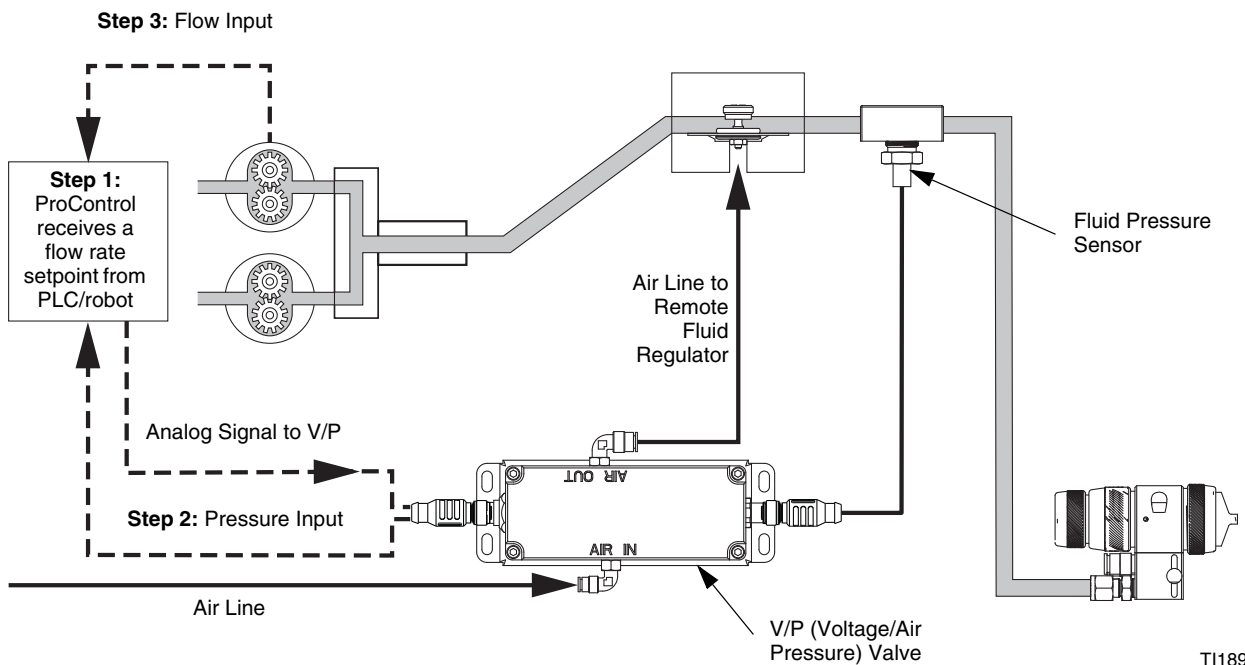

TI18958a

FIG. 86. ProControl 1KS Flow Control Pressure Loop and Flow Loop (24H989 Module)

Flow Control Setup

1. Install the intrinsically safe flow regulator (FC) as explained in the ProControl 1KS Installation Manual.
2. Ensure that the analog signal is 0-10 Vdc, or is properly provided through network communication.
3. Calibrate the system’s flow meters; see page 102. This ensures that the K-factors are tuned to the range of materials being used.
4. Verify that the I/O inputs are working properly. If using discrete I/O, check by viewing **Advanced Setup Screen 6** and **Advanced Setup Screen 7**, page 38. If using network communication, ensure the commands are being sent by viewing the **Status Screen**, page 21, and **Advanced Setup Screen 6** and **Advanced Setup Screen 7**, page 38, for inputs.

NOTE: See the Graco Gateway manual for Flow Control Modbus addresses.

5. See **Flow Control Startup**.

Flow Control Startup

1. Set Flow Control to “On: Setup” in **Configure Screen 5**.

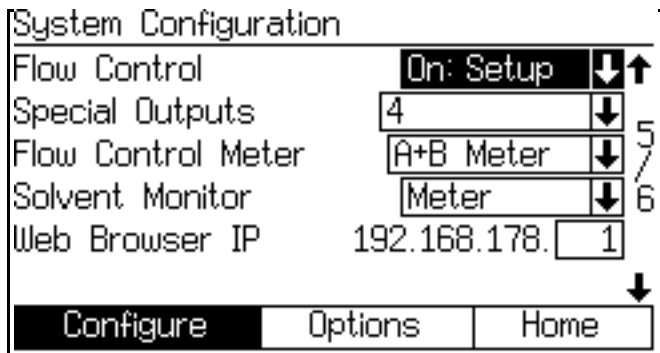

FIG. 87. Configure Screen 5

2. In **Advanced Setup Screen 1**, turn Manual Override “On: EK”. This sets the override control source as the EasyKey. The Flow Control Override field will

appear. The other option, “On: Ext” is used for partial control by a PLC robot.

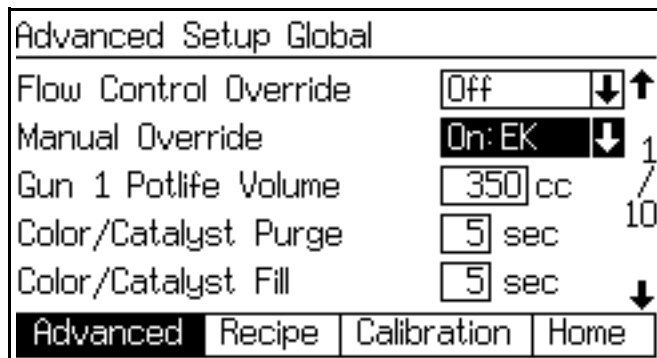

FIG. 88. Advanced Setup Screen 1

3. Set Flow Control Override to % Open. See FIG. 89 and Table 12. On the **Manual Override Screen**, the Flow Set Point field will display as a percentage open (see FIG. 90).

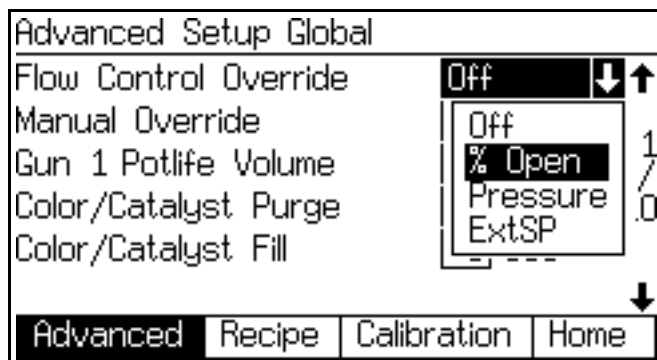

FIG. 89. Flow Control Override Menu

Table 12: Flow Control Override Selections

Selection	Description
Off	Normal operation
% Open	Flow control regulator is opened to a desired percentage.
Pressure	Flow control regulator is opened to a calibrated pressure.
ExtSP	External PLC in control of Set Point

NOTE: Set the Flow Control Override to “Pressure” to use the **Pressure Flow Control Mode** (see page 88).

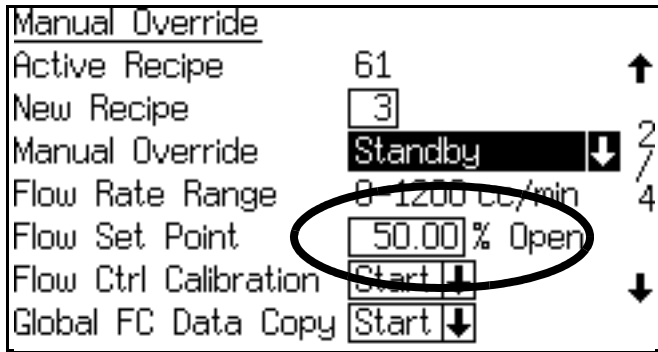

FIG. 90. Flow Set Point as a Percentage

- On the **Manual Override Screen**, drive the regulator to a percentage open that starts fluid flow. Fluid pressure should be above 5 psi (0.034 MPa, 0.34 bar) [see the **Status Screen**]. Observe the fluid flow rate at this pressure. This is the achievable low end flow rate for the system’s given restriction. If a lower flow rate is required, increase the restriction between the flow control regulator and the spray gun.

NOTE: If the lowest flow rate achieved is well below 5 psi (0.034 MPa, 0.34 bar), add restriction to achieve fluid pressure closer to 5 psi. Pressures below 5 psi can be inconsistent.

- Drive the regulator to 100% open. This is the maximum achievable flow rate based on the low flow requirement and the flow control module’s functional range.
- When an acceptable operating range is achieved, turn Flow Control Override Off.

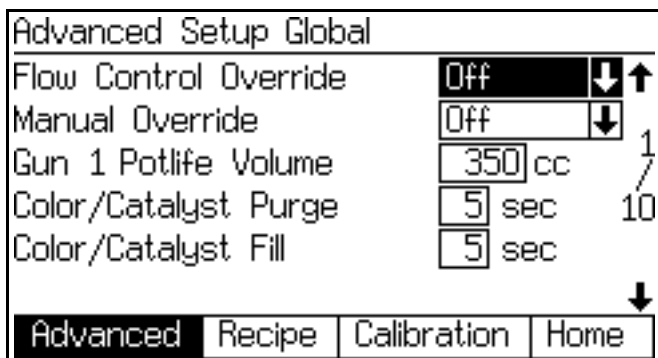

FIG. 91. Advanced Setup Screen 1

- Run **Flow Control Calibration**, page 85.

One-Point Learning

For situations where there are fast gun triggers (less than 2 seconds) there may not be enough stable flow data to allow the flow loop to learn. This situation is also affected by low flow rates (less than 100 cc/min).

If the job sequence contains an extended gun trigger time, instead of learning at individual flow rates the system can instead learn only points above a specified flow rate, which are then linearly interpolated between that point and the (0 Pressure, 0 Flow) origin of the data table.

One-Point Learning Example

Suppose a part has a spray sequence of:

Table 13: Example Spray Sequence

Pass	Flow Rate	Gun Trigger Time
1	50	1 s
2	65	1/2 s
3	50	1 s
4	150	4 s

The system won’t be able to learn the points at 50 and 65 cc/min. However, there is enough data to learn at the 150 cc/min set point.

If the “One-Point threshold” in the **Advanced Setup Screen 6**, page 38 is set to a flow rate such as 100 cc/min, then learning is disabled for flow rates below this. However, when the 150 cc/min pass is active, when the point is learned the linear interpolation is applied for the entire flow rate range.

Flow Control Calibration

Flow Control Calibration is an automatic routine that establishes a pressure vs flow profile between low and high operating points. See FIG. 96. The profile may be unique to each recipe or may be globally copied to all recipes.

NOTE: Calibration cannot be done in recipe 0 or 61.

1. Load a color.
2. Go to **Advanced Setup Screen 5** (see FIG. 92). Select the flow rate range that best covers the largest flow target for your application (for example, 0-1200).

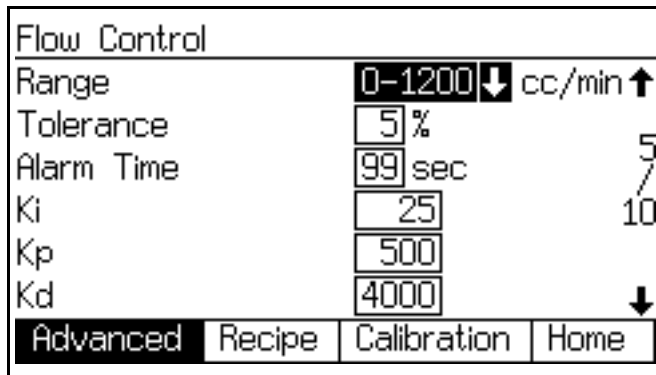

FIG. 92. Advanced Setup Screen 5 (Automatic Mode with Flow Control Only)

3. Go to **Advanced Setup Screen 1** (see FIG. 93). Turn Manual Override On.

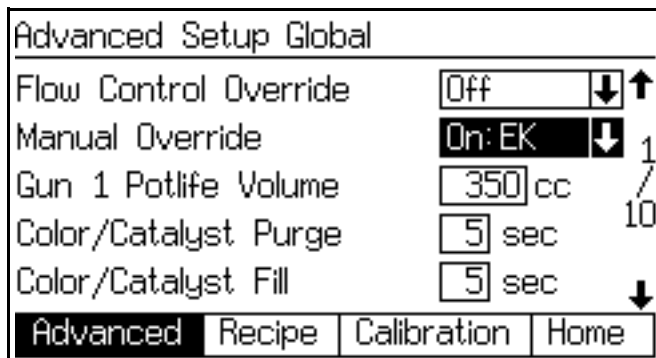

FIG. 93. Advanced Setup Screen 1

4. Go to the **Manual Override Screen** (see FIG. 94). Set Manual Override to Mix, and set Flow Ctrl Calibration to Start.

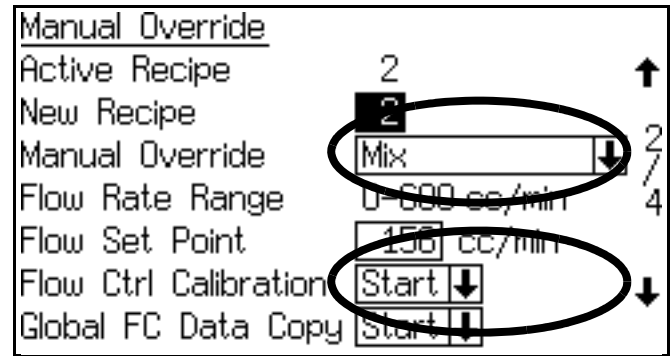

FIG. 94. Manual Override Screen

5. Return to the **Status Screen** (see FIG. 95). The status bar at the bottom of the screen will indicate that Mix Calibration is in progress.

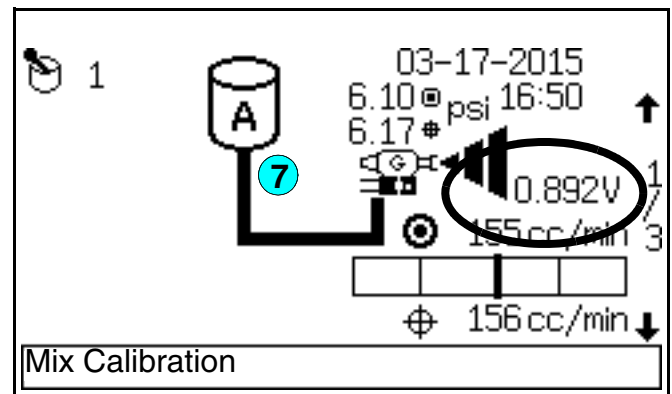

FIG. 95. Status Screen

6. Trigger the gun and make sure the gun trigger input is high.
7. On the **Status Screen** (see FIG. 95), the voltage will start at 0 and increase incrementally to 3.3 V. The flow rate will also begin to increase during calibration, but this may not show for the first few voltage increases.
8. When calibration is complete, the **Status Screen** will change from Mix Calibration to Mix. The unit should have built a complete table for the flow rate range selected in step 2.

NOTE: If the voltage reached 3.3 V (flow control wide open) but the unit did not reach the top of the selected flow rate range, the delivery system is not providing enough volume. Do one of the following:

- If the volume is acceptable, change the flow rate range accordingly.

- If the volume is not acceptable, increase the delivery pressure. Increasing the pressure may affect your low flow rate setting.
9. De-trigger the gun.
 10. Set Manual Override to Standby.

11. To copy the data table to all recipes, see **Global FC Data Copy**, page 86. This loads a starting point for each recipe, and continuous learning will create a unique data table when the recipe is run.

NOTE: If you want to do a flow calibration for each recipe, do not do a **Global FC Data Copy**.

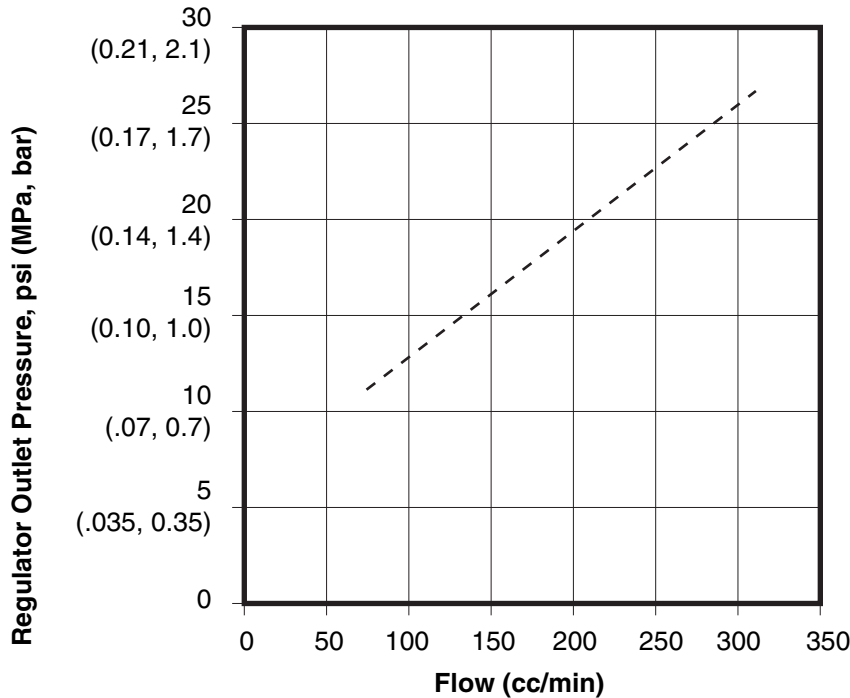

FIG. 96. Typical Flow Calibration (0-300 cc/min range)

Global FC Data Copy

Set Global FC Data Copy to Start on the **Manual Override Screen** (see FIG. 97). Global copy provides a starting point for all recipes, enabling **Continuous Learning** (see page 87) to take over.

Global copy works very well with multiple colors when the viscosities are similar. It may only require a calibration and global copy each time a regulator is serviced or if restriction downstream of the regulator is changed.

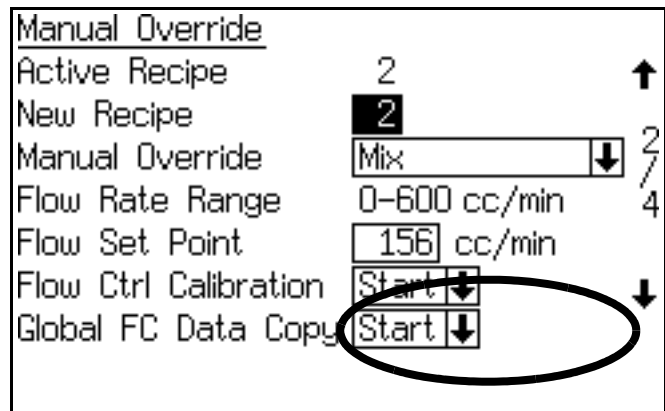

FIG. 97. Manual Override Screen

Continuous Learning

The flow profile will automatically adjust as necessary to drive to the required flow set point, reflecting changes in material viscosity or system dynamics (such as restrictions downstream from the regulator).

When changing recipes, the profile is saved to the current active recipe. A Job Complete input will also save the profile to the active recipe.

Setting Ki and Kp

FIG. 99 shows the definition and relationship between Ki and Kp.

- The default value for Ki is 40.
- The default value for Kp is 400.

For most applications, Ki and Kp do not need to change. Do not change these values unless you are sure it is required.

Before adjusting these values, ensure that the input fluid pressure to the regulator is pulsation free, and the outlet pressure is higher than 12 psi (.08 MPa, 0.84 bar) for each flow rate set point.

Applications with viscosities less than 20 cps or greater than 300 cps may require that the Ki and Kp be adjusted. Do this by making small variable changes to the values in **Advanced Setup Screen 5**. See FIG. 98.

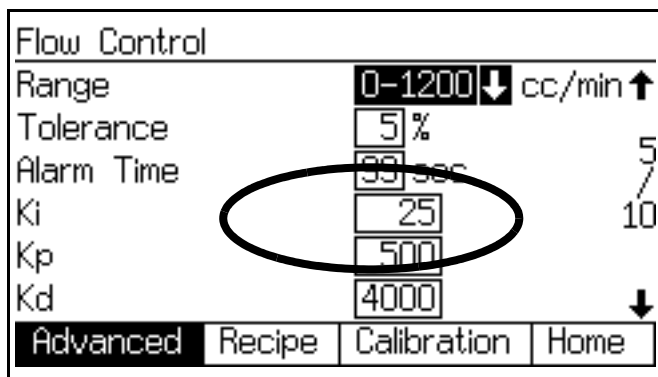
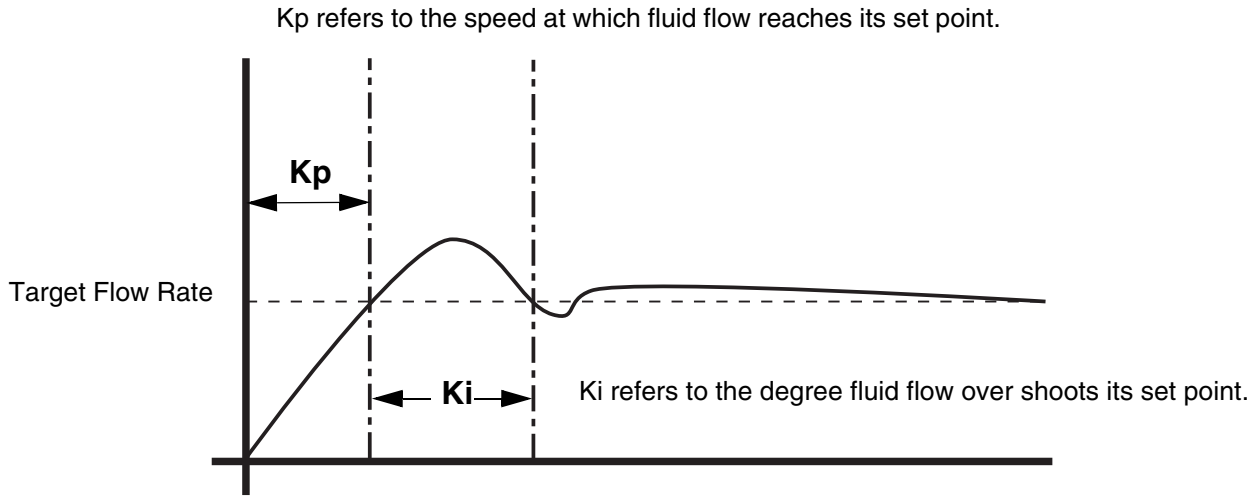

FIG. 98. Advanced Setup Screen 5 (Automatic Mode with Flow Control Only)

Pressure Flow Control Mode

When the Flow Control Override is set to “Pressure”, the system will only drive to the pressure associated with the flow rate request of the saved calibration table. It will not close the loop with the flow meters.

This mode may be used with a ProControl 1KS connected both to a robot with flow control and to a manual gun. Because there are two flow paths, the meters cannot be used to close the flow loop. Therefore the robot can run a calibration by itself. When calibration is complete, set to “Pressure.” The robot will run in open loop mode, and the manual gun can spray at the same time.



NOTE: Ki and Kp are dependent on each other. If one changes the other must change.

T117119a

FIG. 99. Kp/Ki Graph

Flow Control Troubleshooting

Problem: Flow Command does not produce fluid output.

Test the system as follows, to determine if the problem is mechanical or electrical.

1. Install a 0-100 psi (0-0.7 MPa, 0-7.0 bar), 1/8 npt(m) air pressure gauge (not supplied) as follows.
 - a. *For module 249849:* Remove the plug from the 1/8 npt(f) air gauge port and install the gauge. See FIG. 81 on page 78.
 - b. *For module 24H989:* Install a 1/8 npt(m) x 1/8 npt (f) tee in the air outlet port. Install the gauge in one branch of the tee and the air outlet fitting in the other. See FIG. 82 on page 78.
2. Set the system to Manual Override, % Open mode; see steps 2-5 under **Flow Control Startup** on pages 83-84.
3. Set the % Open value to 50. See FIG. 100.

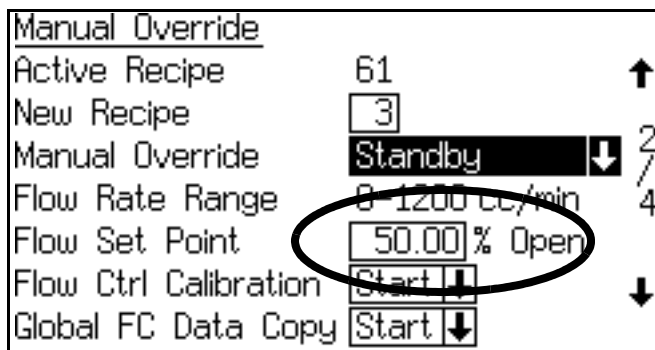

FIG. 100. Set % Open to 50 Percent

4. Ensure that the gun is triggered. Increase the % Open value on the EasyKey, then decrease. The gauge reading should also increase then decrease.

Result of the Test	Cause	Solution
<p>Gauge reading increases and decreases as % Open value is changed and fluid flow does not change or is not present.</p>	<p>The problem is mechanical:</p> <ul style="list-style-type: none"> • restriction/plugged hose • plugged gun tip • fluid regulator failure 	<ol style="list-style-type: none"> 1. Clear any clogs. 2. Remove restrictions. 3. Clean and/or repair fluid regulator.
<p>Gauge reading does not increase and decrease as % Open value is changed.</p>	<p>The problem is electrical:</p> <ul style="list-style-type: none"> • Fuse F2 is blown • disconnected wires or cables • pressure control failure • V/P valve failure • flow control board failure 	<ol style="list-style-type: none"> 1. Measure the voltage to the regulator at one of two places: <ul style="list-style-type: none"> • At J5 on the fluid control board, measure across the white (pin 1) and black (pin 6) wire connections. The voltage should be in the range of 0-3.3 Vdc for 0%-100% Open command (approximately 1.65 Vdc for 50% Open). • At J2 on the flow control board of the module, measure across the red (pin 1) and black (pin 2) wire connections. The voltage should be in the range of 0-21 Vdc for 0%-100% Open command (approximately 12 Vdc for 50% Open). 2. If voltage is not present, check if fuse F2 on the fluid control board is blown. 3. If voltage is present, ensure the cable is properly connected to the module circuit board. 4. If cable is properly connected, replace pressure control, VP valve, and flow control board sequentially to isolate failure. See manual 3A2097.

System Operation

Operation Modes



Mix

System mixes and dispenses material (apply Mix input).



Standby

Stops the system (remove Mix input).



Purge

Purges the system, using air and solvent (apply Purge

input).

Recipe (Color) Change

The process when the system automatically flushes out the old color and loads a new color. See pages 104-116.

Solvent Push

The Solvent Push feature enables the user to save some mixed material by pushing it out to the gun with solvent. The feature requires an accessory solvent meter. See page 101 for complete information.

Mix Manifold Valve Settings

To open dose or purge valves, turn hex nut (E) *counter-clockwise*. To close, turn *clockwise*. See Table 14 and FIG. 101.

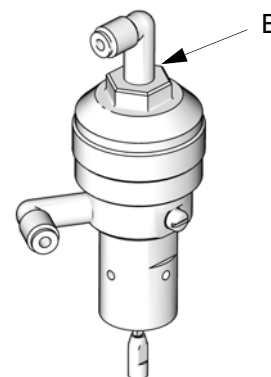

TI11581a

FIG. 101. Valve Adjustment

Table 14: Mix Manifold Valve Settings

Valve	Setting	Function
Dose (see FIG. 101)	Hex nut (E) 1-1/4 turns out from fully closed	Limits maximum fluid flow rate into integrator and minimizes valve response time.
Purge (see FIG. 101)	Hex nut (E) 1-1/4 turns out from fully closed	Limits maximum fluid flow rate into integrator and minimizes valve response time.

Start Up

1. Go through the Pre-Operation Checklist in Table 15.

Table 15: Pre-Operation Checklist

✓	Checklist
	<p>System grounded</p> <p>Verify all grounding connections were made. See the Installation manual.</p>
	<p>All connections tight and correct</p> <p>Verify all electrical, fluid, air, and system connections are tight and installed according to the Installation manual.</p>
	<p>Check air purge valve tubing</p> <p>Check the air purge valve supply tube daily for any visible solvent accumulation. Notify your supervisor if solvent is present.</p>
	<p>Fluid supply containers filled</p> <p>Check component A and B and solvent supply containers.</p>
	<p>Mix manifold valves set</p> <p>Check that mix manifold valves are set correctly. Start with the settings recommended in Mix Manifold Valve Settings, page 91, then adjust as needed.</p>
	<p>Fluid supply valves open and pressure set</p> <p>Component A and B fluid supply pressures should be equal unless one component is more viscous and requires a higher pressure setting.</p>
	<p>Solenoid pressure set</p> <p>75-100 psi inlet air supply (0.5-0.7 MPa, 5.2-7 bar)</p>

2. Turn the AC Power Switch ON (I = ON, 0 = OFF).

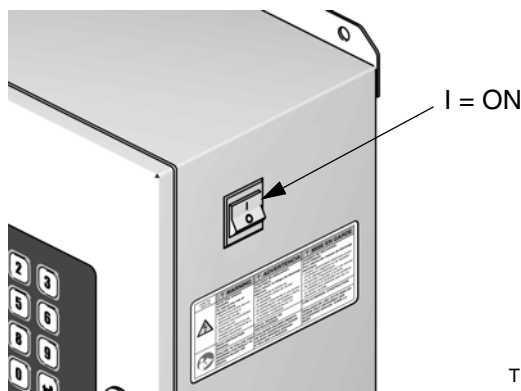

FIG. 102. Power Switch

- Graco logo, software revision, and “Establishing Communication” will display, followed by Status screen. See page 19.
- At power up the system defaults to Recipe 61, which is not a valid recipe number. Initiate a color change to Recipe 0 or a valid recipe number (1-60).
- In bottom left corner, the system status displays, which can be Standby, Mix, Purge, or an alarm notification.

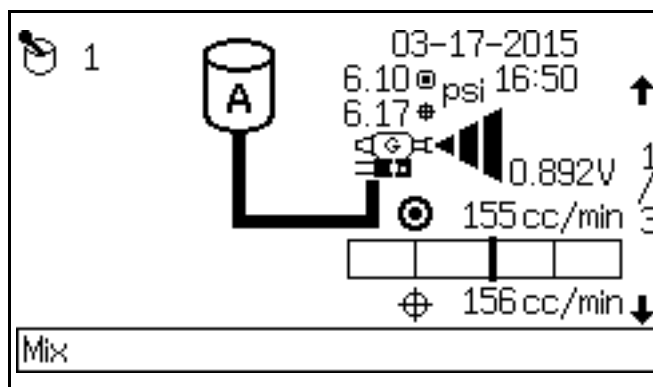

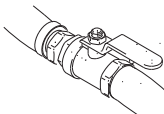
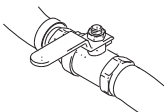
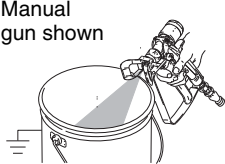

FIG. 103. Status Screen

3. Verify that the EasyKey is working. The active recipe number and Standby mode should be displayed.
4. If this is the first time starting up the system, purge it as instructed in **Purging Fluid Supply System**, page 99. The equipment was tested with lightweight oil, which should be flushed out to avoid contaminating your material.
5. Make sure that the EasyKey is in Standby (remove Mix input).

6. Adjust component A and B fluid supplies as needed for your application. Use lowest pressure possible. 
7. Do not exceed the maximum rated working pressure shown on the system identification label or the lowest rated component in the system.
8. Open the fluid supply valves to the system. 
9. Adjust the air pressure. Most applications require about 80 psi (552 kPa, 5.5 bar) air pressure to operate properly. Do not use less than 75 psi (517 kPa, 5.2 bar).
10. Purge air from the fluid lines.

- a. Shut off air to the gun by closing the air regulator or shutoff valve for the gun atomizing air. 

- b. Trigger the gun (manual or automatic) into a grounded metal pail. 

- c. Go to Mix mode.

- d. If the flow meters over-run because of air in the system, an alarm will occur and operation stops.

Press the Alarm Reset  key to clear alarm.

- e. Go to Mix mode.

11. Adjust the flow rate.

The fluid flow rate shown on the EasyKey Status screen is for either component A or B, depending on which dose valve is open. The fluid supply lines on the screen highlight to show which dose valve is open.

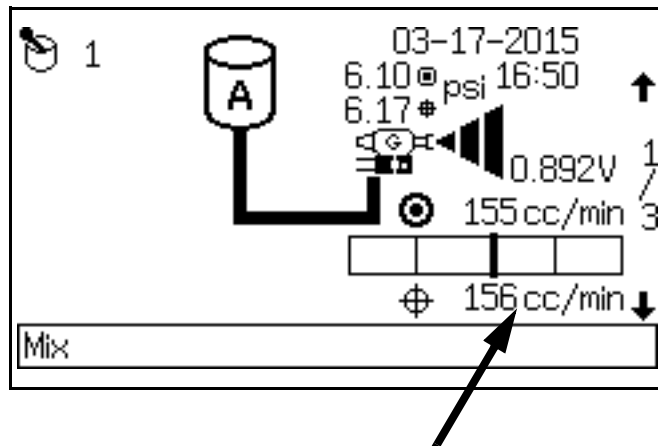

FIG. 104. Status Screen Flow Rate Display

Watch the fluid flow rate displayed on the Status screen while the gun is fully open. Verify that the flow rate of components A and B are within 10% of each other.

If the fluid flow rate is too low: increase air pressure to component A and B fluid supplies or increase the regulated fluid pressure.

If the fluid flow rate is too high: reduce the air pressure, close the fluid manifold dose valves further, or adjust the fluid pressure regulator.

NOTE: Pressure adjustments of each component will vary with fluid viscosity. Start with the same fluid pressure for component A and B, then adjust as needed.

NOTE: Do not use the first 4-5 oz. (120-150 cc) of material as it may not be thoroughly mixed due to alarms while priming the system.

12. Turn on atomizing air to the gun. Check the spray pattern as instructed in your spray gun manual.

NOTE: Do not allow a fluid supply tank to run empty. It is possible for air flow in the supply line to turn gear meters in the same manner as fluid. This can lead to the proportioning of fluid and air that meets the ratio and tolerance settings of the equipment. This can further result in spraying uncatalyzed or poorly catalyzed material.

Shutdown

Overnight Shutdown

1. Leave the power on.
2. Run Recipe 0 to purge solvent through meters and gun.

Service Shutdown

1. Follow **Pressure Relief Procedure** on page 94.
2. Close main air shutoff valve on air supply line and on ProControl 1KS.
3. Shut off ProControl 1KS power (0 position). FIG. 105.
4. If servicing EasyKey, also shut off power at main circuit breaker.

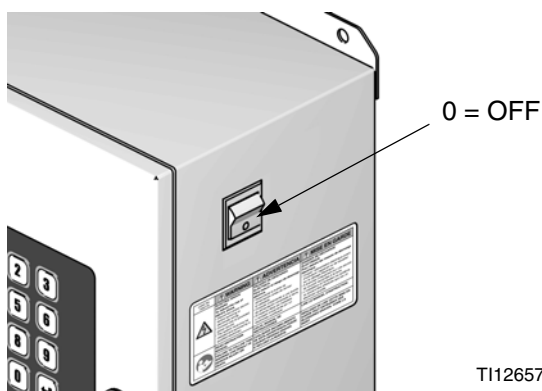
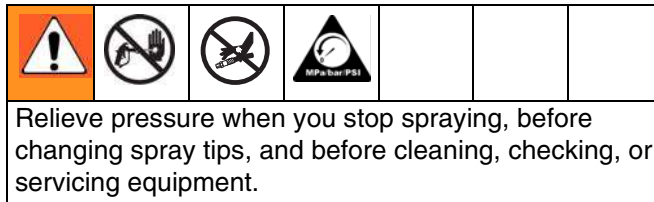

FIG. 105. Power Switch

T112657a

Pressure Relief Procedure

NOTE: The following procedures relieve all fluid and air pressure in the ProControl 1KS system. Use the procedure appropriate for your system configuration.



Single Color Systems

1. While in Mix mode (gun triggered), shut off the A and B fluid supply pumps/pressure pots. Close all fluid shutoff valves at the pump outlets.
2. With the gun triggered, push the manual override on the A and B dose valve solenoids to relieve pressure. See FIG. 106.

NOTE: If a Dose Time alarm (E-7, E-8) occurs, clear the alarm.

3. Do a complete system purge, following the instructions under **Purging Using Recipe 0**, page 99.
4. Shut off the fluid supply to the solvent purge valve (SPV) and the air supply to the air purge valve (APV), FIG. 108.
5. With the gun triggered, push the manual override on the A and B purge valve solenoids to relieve air and solvent pressure. See FIG. 106. Verify that solvent pressure is reduced to 0.

NOTE: If a Purge Volume alarm (E-11) occurs, clear the alarm.

Systems with Color Change and Dump Valves

NOTE: This procedure relieves pressure through the sampling valve.

1. Complete all steps under **Single Color Systems**, page 94.
2. Shut off all color supplies going to the color change valve stack(s).
3. Open the Fluid system control box. Press and hold the dump valve solenoid override, FIG. 106.
4. See FIG. 107. Open the color change module. Using the solenoid identification labels as a guide, press and hold the override button on each color solenoid until flow from the sampling valve stops.
5. Press and hold the dump valve solenoid override, FIG. 106 (see step 3).
6. Press and hold the Color stack solvent solenoid override until clean solvent comes from the dump valve, then release.
7. Shutoff the solvent supply to the color change stack solvent valve.
8. Press and hold the solvent solenoid override and dump valve override until solvent flow from the dump valve stops.

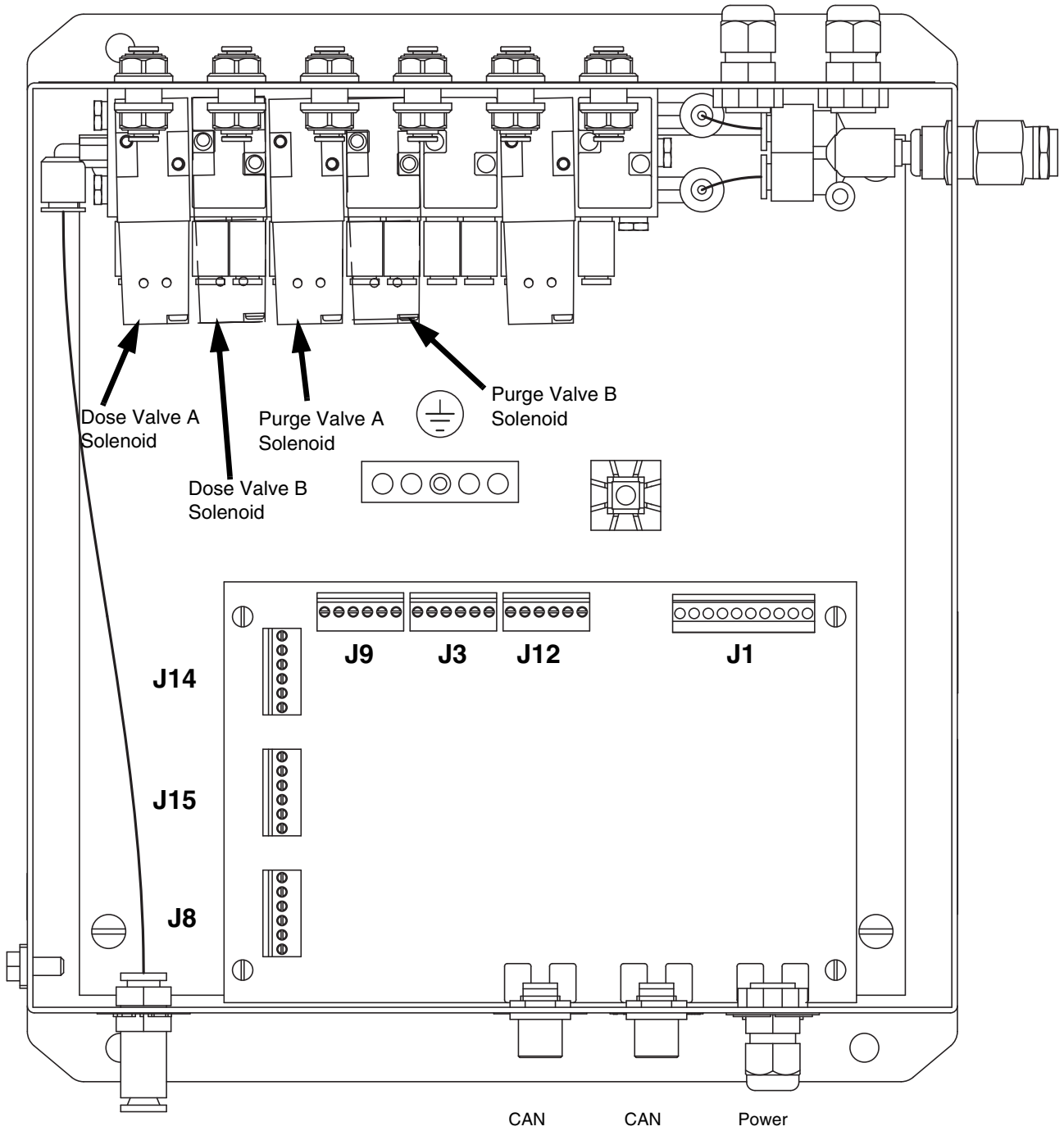

T115916a

FIG. 106. Fluid Solenoids

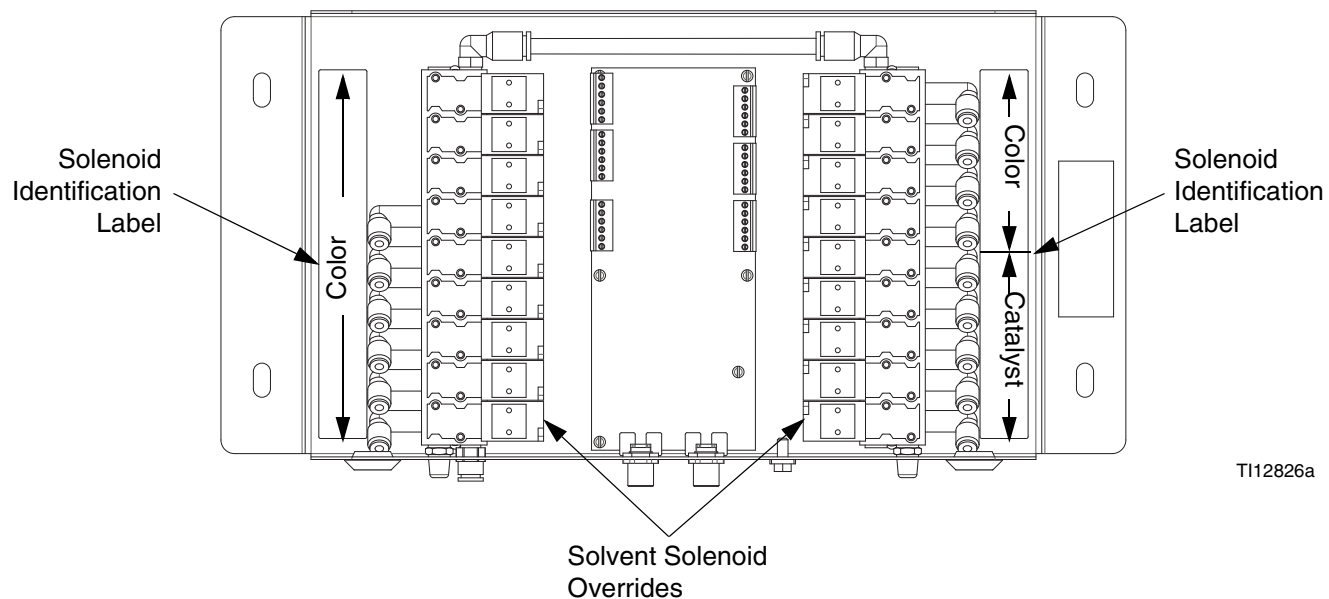

FIG. 107: Color Change Solenoids

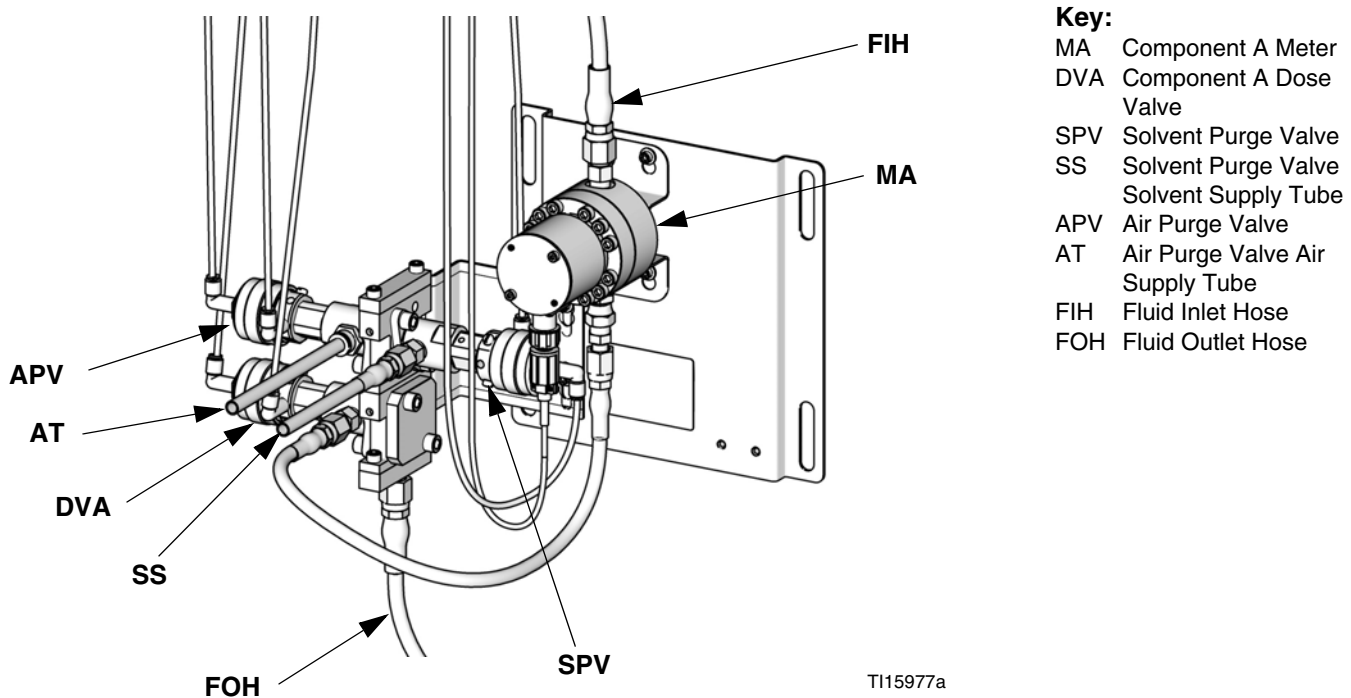







FIG. 108. Wall Mount Fluid Station

Purging

						
<p>Read Warnings, page 6. Follow the Grounding instructions in your system Installation manual.</p> <p>To avoid splashing fluid in the eyes, wear eye protection.</p>						

There are 3 purging procedures in this manual:

- **Purging Mixed Material** (below)
- **Purging Using Recipe 0** (page 99)
- **Purging Fluid Supply System** (page 99)



Use the criteria listed in each procedure to determine which procedure to use.



Purging Mixed Material

There are times when you only want to purge the fluid manifold, such as:

- end of potlife
- breaks in spraying that exceed the potlife
- overnight shutdown
- before servicing the fluid manifold assembly, hose or gun.

1. Go to Standby mode (remove Mix input).

						
<p>Trigger the gun to relieve pressure.</p> <p>If you are using a high pressure gun, engage the trigger lock. Remove spray tip and clean tip separately.</p>						

						
<p>If using an electrostatic gun shut off the electrostatics before flushing the gun.</p>						

2. Set the solvent supply pressure regulator at a pressure high enough to completely purge the system in a reasonable amount of time but low enough to avoid splashing or an injection injury. Generally, a setting of 100 psi (0.7 MPa, 7 bar) is sufficient.
3. If using a gun flush box, place the gun into the box and close the lid. Go to Purge mode. The purge sequence automatically starts.

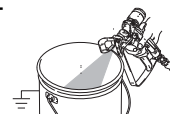

If the gun flush box is not used, trigger the gun (manual or automatic) into a grounded metal pail until the purge sequence is complete.



When done purging, the EasyKey automatically switches to Standby mode.

4. If the system is not completely clean, repeat step 3.

NOTE: If necessary, adjust purge sequence so only one cycle is required.

						
<p>Trigger the gun to relieve pressure. Engage trigger lock.</p>						



5. If spray tip was removed, reinstall it.
6. Adjust the solvent supply regulator back to its normal operating pressure.



Purging Using Recipe 0



Recipe 0 is typically used: in multiple color systems to purge out material lines without loading a new color

To setup Recipe 0, go to Advanced Setup. Select the Recipe tab and change the Recipe to 0. The Recipe 0 Setup Screen appears. Set the chop times from 0-999 seconds in increments of 1 second.

1. Go to Standby mode (remove Mix input).

						
Trigger the gun to relieve pressure.						
If you are using a high pressure gun, engage the trigger lock. Remove spray tip and clean tip separately.						

						
If using an electrostatic gun shut off the electrostatics before flushing the gun.						

2. If using a gun flush box, place the gun into the box and close the lid.
3. Select Recipe 0 and press Enter .
4. If a gun flush box is not used, trigger the gun (manual or automatic) into a grounded metal pail until the purge sequence is complete. 
5. The color change LED blinks while Recipe 0 runs and turns solid after purge sequence is complete.
6. If the system is not completely clean, you can repeat Recipe 0 by pressing Enter .



Purging Fluid Supply System



Follow this procedure before:

- the first time material is loaded into equipment*
- servicing
- shutting down equipment for an extended period of time
- putting equipment into storage

* Some steps are not necessary for initial flushing, as no material has been loaded into the system yet.

1. Go to Standby mode (remove Mix input).

						
Trigger the gun to relieve pressure.						
If you are using a high pressure gun, engage the trigger lock. Remove spray tip and clean tip separately.						

						
If using an electrostatic gun, shut off the electrostatics before flushing the gun.						

2. Attach solvent supply lines as follows:
 - **Single color systems:** disconnect the fluid supply at the flow meter inlet, and connect regulated solvent supply lines.
 - **Multiple color systems:** disconnect the fluid supply at the flow meter inlet and connect a regulated solvent supply line.

3. Adjust the solvent fluid supply pressure. Use the lowest possible pressure to avoid splashing.
4. Remove the Fluid Station Control Box cover to access the solenoid valves. See FIG. 106 on page 96.
5. Purge as follows:
 - **Single color systems:** Press the manual override on the Dose Valve A solenoid valve and trigger the gun into a grounded metal pail until clean solvent flows from the gun.
 - **Multiple color systems:** Select Recipe 0 and press Enter . The color change LED blinks while Recipe 0 runs and turns solid after purge sequence is complete.
6. Reinstall the Fluid Station Control Box cover.
7. Shut off the solvent fluid supply.
8. Disconnect the solvent supply lines and reconnect the fluid supply.
9. See page 92 for **Start Up** procedure.

Solvent Push Feature

The Solvent Push feature enables the user to save some mixed material by pushing it out to the gun with solvent. The quantity saved is 50% of the potlife volume entered in **Advanced Setup Screen 1** on page 35. If there are 2 guns, the smaller potlife volume is used.

Solvent Push requires an accessory solvent meter (MS). Order Graco Part No. 16D329 S3000 Solvent Meter Kit. See manual 308778.

1. See FIG. 109. Install the solvent meter (MS) on the side of the fluid station, as explained in the ProControl 1KS Installation Manual.
2. To enable Solvent Push, select "Solvent" or "3rd Valve," as desired. See **Option Screen 2**, page 33.

NOTE: If you are using a 3rd purge valve instead of the solvent purge valve to run the Solvent Push feature, connect the solvent supply line from the solvent meter to the inlet of the 3rd purge valve.



NOTE: The system must be in Mix to initiate Solvent Push.

3. Press and hold the Mix  key for 5 seconds to turn on Solvent Push. The green Mix LED will

light and the Recipe LED will blink. The system will close the Dose Valves (DVA, DVB) and open the Solvent Purge Valve (SPV).

4. The system will dispense solvent to push the mixed material out to the gun. The Booth Control display alternately shows dashes and the percent remaining (0-99%) of the 50% of the potlife volume.

NOTE: To manually interrupt Solvent Push, press the

Standby  key. The Solvent Purge Valve (SPV) or 3rd purge valve will close. To re-enter Solvent Push, press the Mix  key.

5. When the total solvent dispensed exceeds 50% of the potlife volume, the system will go into Standby

 mode.

6. Perform a manual purge or recipe change to purge the remaining mixed material. This will clear the system out of Solvent Push, allowing you to resume Mix mode.

NOTE: Once the system senses that solvent exceeds 50% of potlife volume, attempts to re-enter Solvent Push will cause an Overdose_A/B Alarm (E-5, E-6).

Key:

MA	Component A Meter
DVA	Component A Dose Valve
SPV	Solvent Purge Valve
SS	Solvent Purge Valve Solvent Supply Tube
APV	Air Purge Valve
AT	Air Purge Valve Air Supply Tube
FIH	Fluid Inlet Hose
FOH	Fluid Outlet Hose

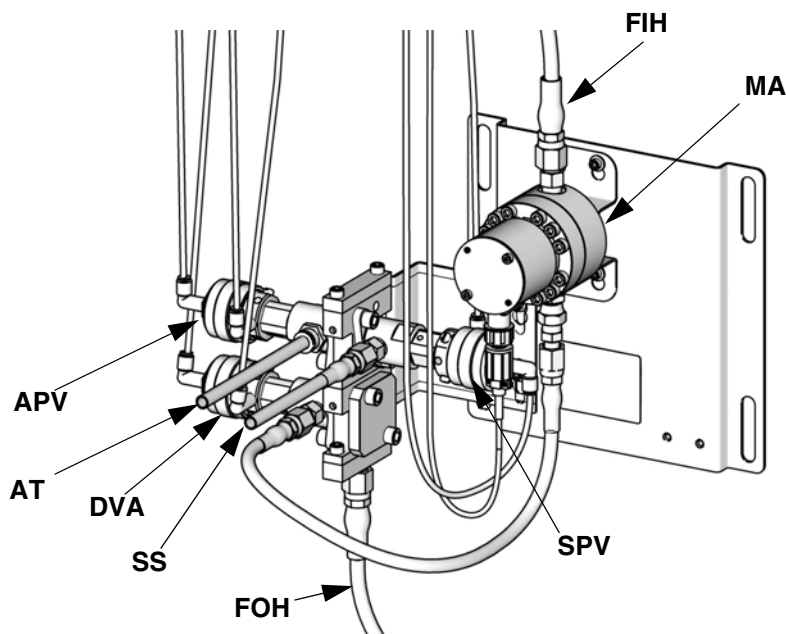

T115977a

FIG. 109. Solvent Push Setup

Meter Calibration

--	--	--	--	--	--	--

To avoid splashing fluid in the eyes, wear eye protection. The fluid shutoff valves and ratio check valves are retained by mechanical stops that prevent accidental removal of the valve stem while the manifold is pressurized. If you cannot turn the valve stems manually, relieve the system pressure, then disassemble and clean the valve to remove the resistance.

Calibrate the meter:

- The first time the system is operated.
- Whenever new materials are used in the system, especially if the materials have viscosities that differ significantly.
- At least once per month as part of regular maintenance.
- Whenever a flow meter is serviced or replaced.

NOTE:

- K-factors on the **Calibration Screen** are updated automatically after the calibration procedure is completed.
 - K-factor values on the screen are viewable only. If needed, you can manually edit the K-factors in **Advanced Setup Screen 4** (see page 37) or **Recipe Setup Screen 5** (page 43).
 - All values on this screen are in cc, independent of the units set in **Configure Screen 1**.
 - The controller will use the active recipe K-factors for meter calibration. **The active recipe must be recipe 1 to recipe 60. Recipes 0 and 61 do not have K-factor values.**
1. Before calibrating meter A, prime the system with material. For a color change system, make sure the color valve is open.
 2. Shut off all spray or dispense devices connected to the ProControl 1KS.
 3. Place the beaker (minimum size - 250 cc) to capture fluid from the gun.

4. On the EasyKey, press the Setup key to access setup screens.
5. Select **Recipe & Advanced Setup** and press the Enter key to select.

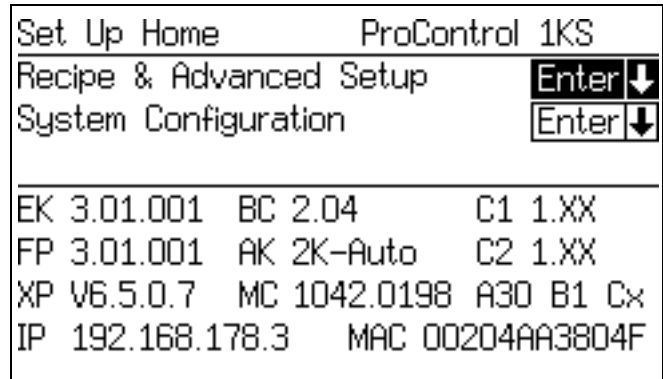

6. Press the Right Arrow key to select the **Calibration Screen**. Press the Enter key to select A Meter. Press the Down Arrow key and select Start from the menu. Start only one at a time.

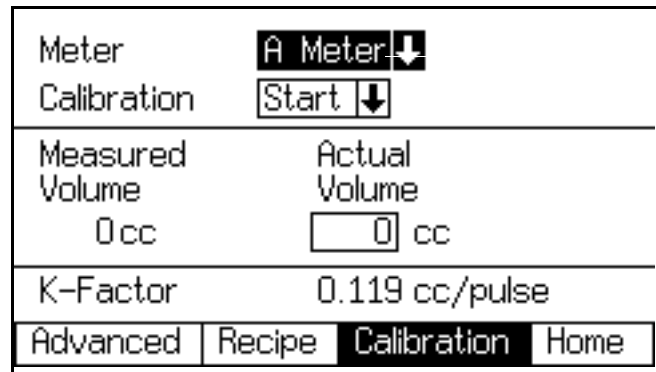

7. Dispense component A into beaker.

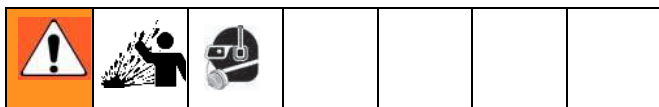

- a. To avoid splashing, slowly open sampling valves.
 - b. For more accurate calibration, adjust the valve to dispense at a flow rate similar to your production spray flow rate.
 - c. Dispense a minimum of 250 cc; make sure enough material is dispensed to accurately read the volume with your beaker.
 - d. Close sampling valve tightly.
8. The volume that the ProMix measured displays on the EasyKey.
9. Compare the amounts on the EasyKey to the amount in the beakers.

NOTE: For maximum accuracy, use a gravimetric (mass) method to determine the actual volumes dispensed.

10. If the screen and actual volumes are different, enter the actual dispensed volume in cc for A or Solvent Volume field, and press the Enter  key.

If the value was substantially different, repeat the calibration process.

NOTE: If the screen and actual volume is the same or if for any reason you want to cancel the calibration procedure, scroll to Abort on the **Calibration Screen** menu and press the Enter  key.

11. After the volume for A or Solvent is entered, the K-factor is calculated and shows it on the **Calibration Screen**.

NOTE: K-factor values on the screen are viewable only. If needed, you can manually edit the K-factors in **Advanced Setup Screen 4** (page 37) or **Recipe Setup Screen 5** (page 43).

12. Always purge sampling valves after calibrating meters. Use one of the following methods.
- Follow the **Solvent Push Feature** procedure, page 101.
 - Place the sampling valve fluid tubes into a compatible cleaning fluid (TSL or solvent) or cap them.
- NOTE:** If fluid hardens in sampling tubes, replace them with 5/32 in. or 4 mm OD tubing.
13. Make sure both sampling valves are closed and both fluid shutoff valves are fully open.
14. Before you begin production, clear the system of solvent and prime it with material.
- a. Go to Mix mode.
 - b. Trigger the gun into a grounded metal pail until mixed material flows from the gun nozzle.
 - c. To begin operation, see **Start Up**, page 92.

Color Change

Color Change Procedures

Multiple Color Systems

1. Shut off air to the gun.
2. Place the gun in the gun flush box if used, and close the lid.
3. Go to Standby mode (remove Mix input).
4. Select the new recipe. Begin the color change sequence.
5. If a gun flush box is not used, trigger the gun (manual or automatic) into a grounded metal pail until the color change sequence is complete.

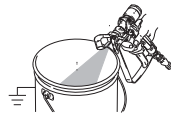

NOTE: The color change timer does not start until a Gun Trigger input is seen and fluid flow is detected. If no flow is detected within 2 minutes, the color change operation aborts. The system enters

Standby  mode (remove Mix input) at the previous color.

6. When you are ready to spray, remove the gun from the gun flush box if used, and close its door (manual and semi-automatic systems only).

NOTE: The gun flush box door must be closed for the atomizing air valve to open.

7. Enter Mix  mode to start spraying.

Single Color Systems

1. Follow procedure for **Purging Fluid Supply System**, page 99.
2. Load the new color. See **Start Up**, page 92.
3. Enter Mix  mode to start spraying.

Color Change Sequences

FIG. 110 through FIG. 119 illustrate various color change sequences. See Table 16 to determine which figure to reference, based on the recipe change and system configuration.

NOTE: For software version 2.04.xxx and older, the system uses the color/catalyst purge and fill times from the new recipe.

NOTE: See **Setup Mode** on page 25 to select purge sources and set desired purge, chop, and fill times.

NOTES:

- The system uses old recipe data for the purge cycle. However, it opens the new color/catalyst valve based on the new recipe data.
- The system uses the new recipe data for the fill cycle.
- For the one gun flush box (GFB) option, the spray gun must be inserted in the GFB during the entire color change cycle (purge and fill). The GFB trigger output will be on during the recipe change cycle.
- For the two gun flush box (GFB) option, both spray guns must be inserted in the GFBs during the entire color change cycle (purge and fill). The system will turn each GFB trigger output on and off based on the preset time for each gun.
- For Special Outputs options, the system will turn each output on and off based on the preset times. Each Special Output has two different start times and durations.
- For systems without dump valves, the First Purge begins after the Color/Catalyst Change steps are completed.
- Dump Valve B is required for a Catalyst Change system.
- When going from Recipe X to Recipe 0, only the purge cycle data from Recipe 0 is used.
- When going from Recipe 0 to Recipe Y, only the fill cycle data from Recipe Y is used.

Color Purge/Dump

- This sequence flushes out the color with solvent, from the color valve to the Dump A valve.
- The color change solvent valve and the Dump A valve open during the Purge Time.
- The color change solvent valve closes when the Purge Time expires.

Color Fill

- This sequence fills the line with the new color all the way to the Dump A valve.
- The new color valve and the Dump A valve open during the Fill Time.
- The new color valve and the Dump A valve close when the Fill Time expires.

Catalyst Purge/Dump

- This sequence flushes out the catalyst with solvent, from the catalyst valve to the Dump B valve.
- The catalyst change solvent valve and the Dump B valve open during the Purge Time.
- The catalyst change solvent valve closes when the Purge Time expires.

Catalyst Fill

- This sequence fills the line with the new catalyst all the way to the Dump B valve.
- The new catalyst valve and the Dump B valve open during the Fill Time.
- The new catalyst valve and the Dump B valve close when the Fill Time expires.

First Purge

Select the First Purge Source (air, solvent, or 3rd valve) and First Purge Time. For most applications, air is selected.

The system purges the old material from the dose valves to the gun, using only the selected purge media (usually air). The selected purge valve opens during the First Purge Time and closes when the time expires.

Chop Cycle

Select the Chop Type (air/solvent or air/3rd valve) and Chop Times.

The air purge valve opens only during the air chop cycle, and the solvent (or 3rd valve) opens only during the solvent chop cycle. The number of chop cycles is determined by dividing the Total Chop Time by the sum of the Air and Solvent Chop Times.

Final Purge

Select the Final Purge Source (air, solvent, or 3rd valve) and Final Purge Time. For most applications, solvent is selected.

The system fills the line with solvent from the dose valves to the gun, using only the selected purge media (usually solvent). The selected purge valve opens during the Final Purge Time and closes when the time expires.

Fill

This sequence fills the line from the dose valves to the gun, and is also referred to as the mixed material fill. The system begins mixing components A and B until the Fill Time expires.

Table 16: Color Change Chart Reference

Starting Recipe	Ending Recipe	Change Type	Dump A	Exiting Fill?	Refer to Fig.
X	Y	Change	Yes	NA	FIG. 110
X	Y	Change	No	NA	FIG. 111
0	Y	Fill	Yes	Yes	FIG. 112
0	Y	Fill	Yes	No	FIG. 113
0	Y	Fill	No	Yes	FIG. 114
0	Y	Fill	No	No	FIG. 115
X	0	Purge	Yes	NA	FIG. 116
X	0	Purge	No	NA	FIG. 117
0	0	Purge	Yes	NA	FIG. 118
0	0	Purge	No	NA	FIG. 119

ProControl 1KS Recipe Change Chart #1 X to Y
 Stack Valves A1 to A2
 Dump A Enabled, 3rd Flush Valve Enabled

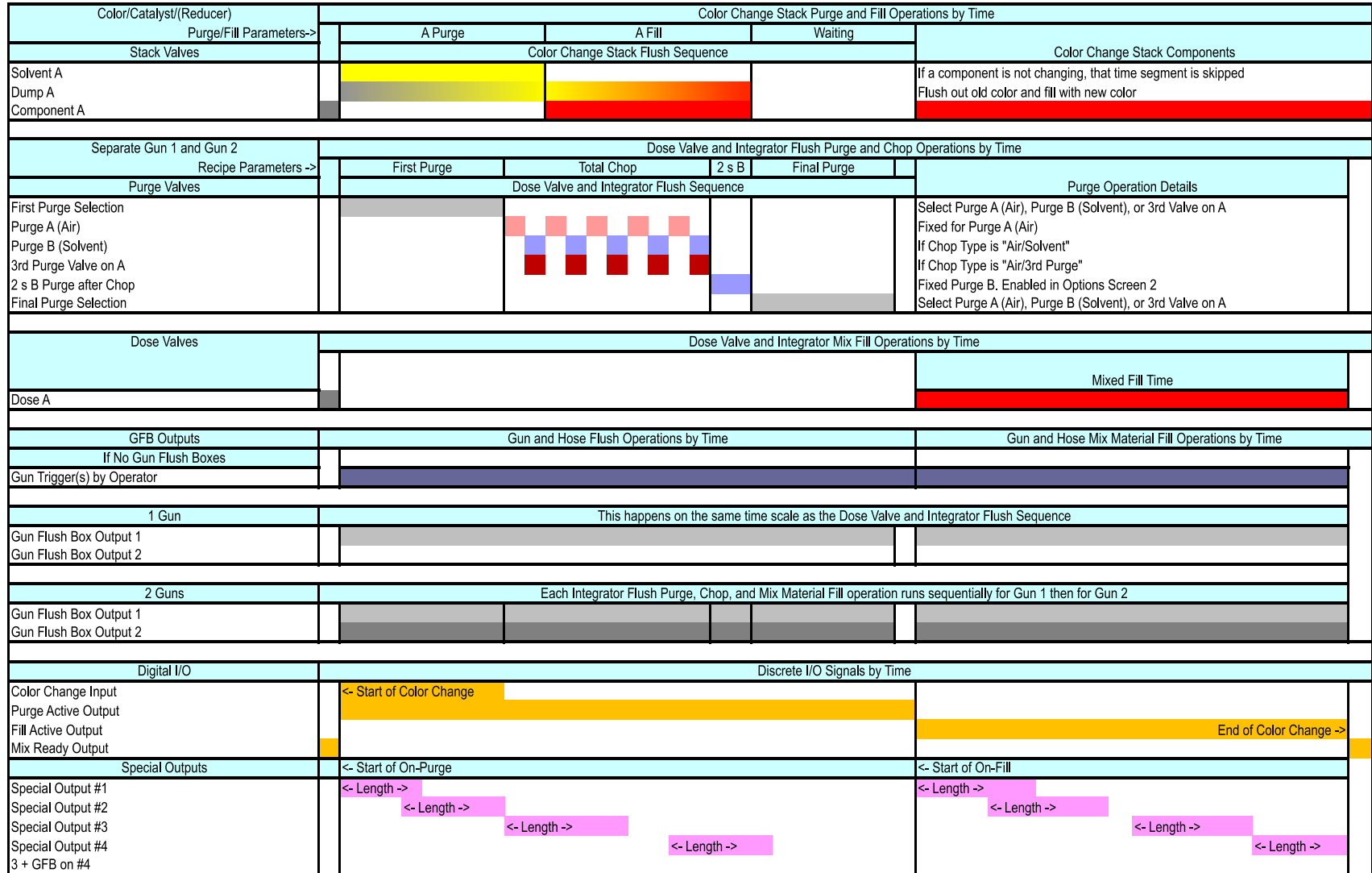

1KS X to Y K11 EN

FIG. 110: ProControl 1KS Recipe Change Chart #1 X to Y

ProControl 1KS Recipe Change Chart #2 X to Y
 Stack Valves A1 to A2
 Dump A Enabled, 3rd Flush Valve Enabled

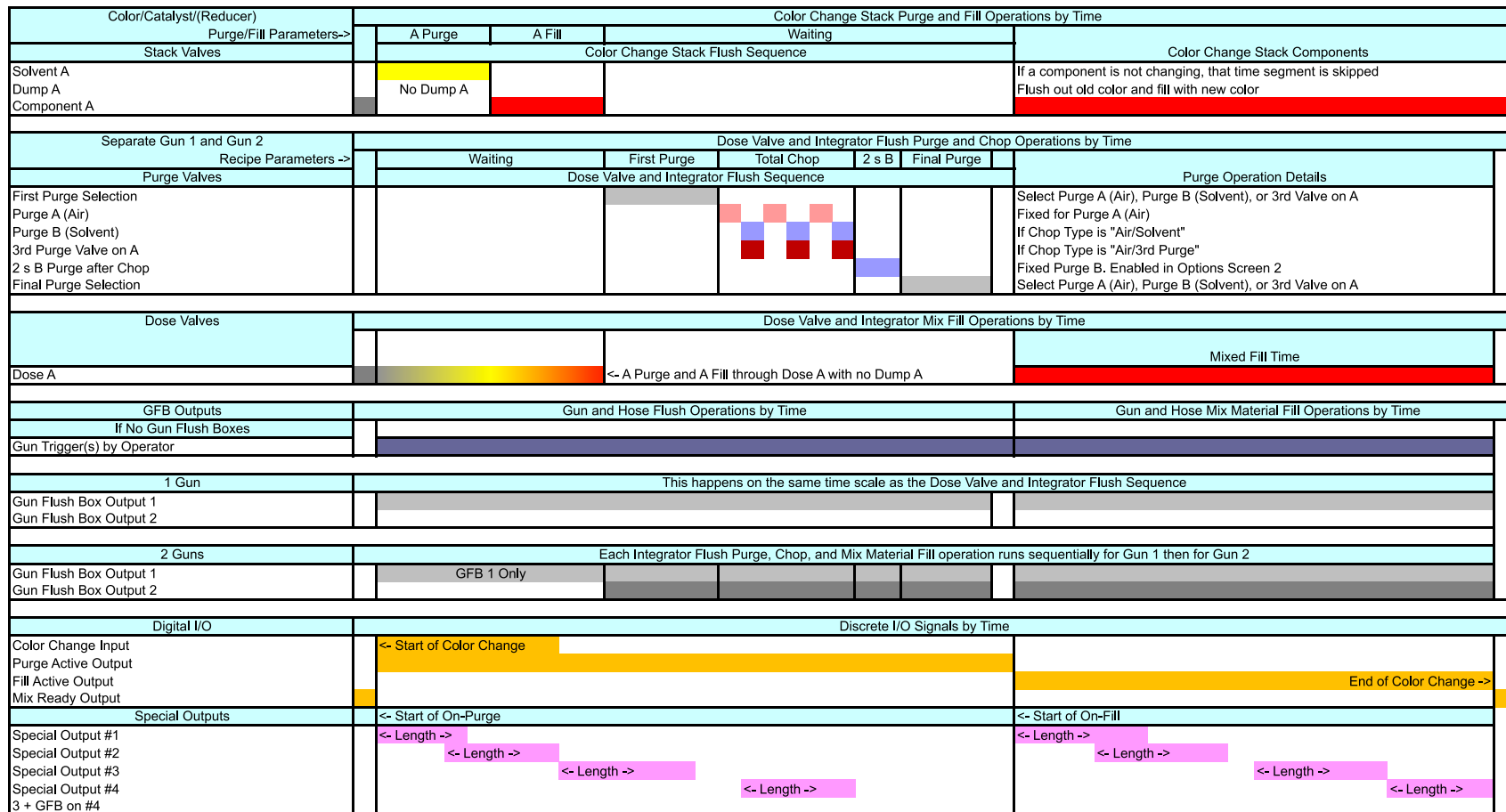

1KS X to Y K9 EN

Fig. 111: ProControl 1KS Recipe Change Chart #2 X to Y

ProControl 1KS Recipe Fill Chart #3 0 to Y
 Stack Valves A1
 Dump A Enabled, 3rd Flush Valve Enabled
 Exiting Fill Enabled

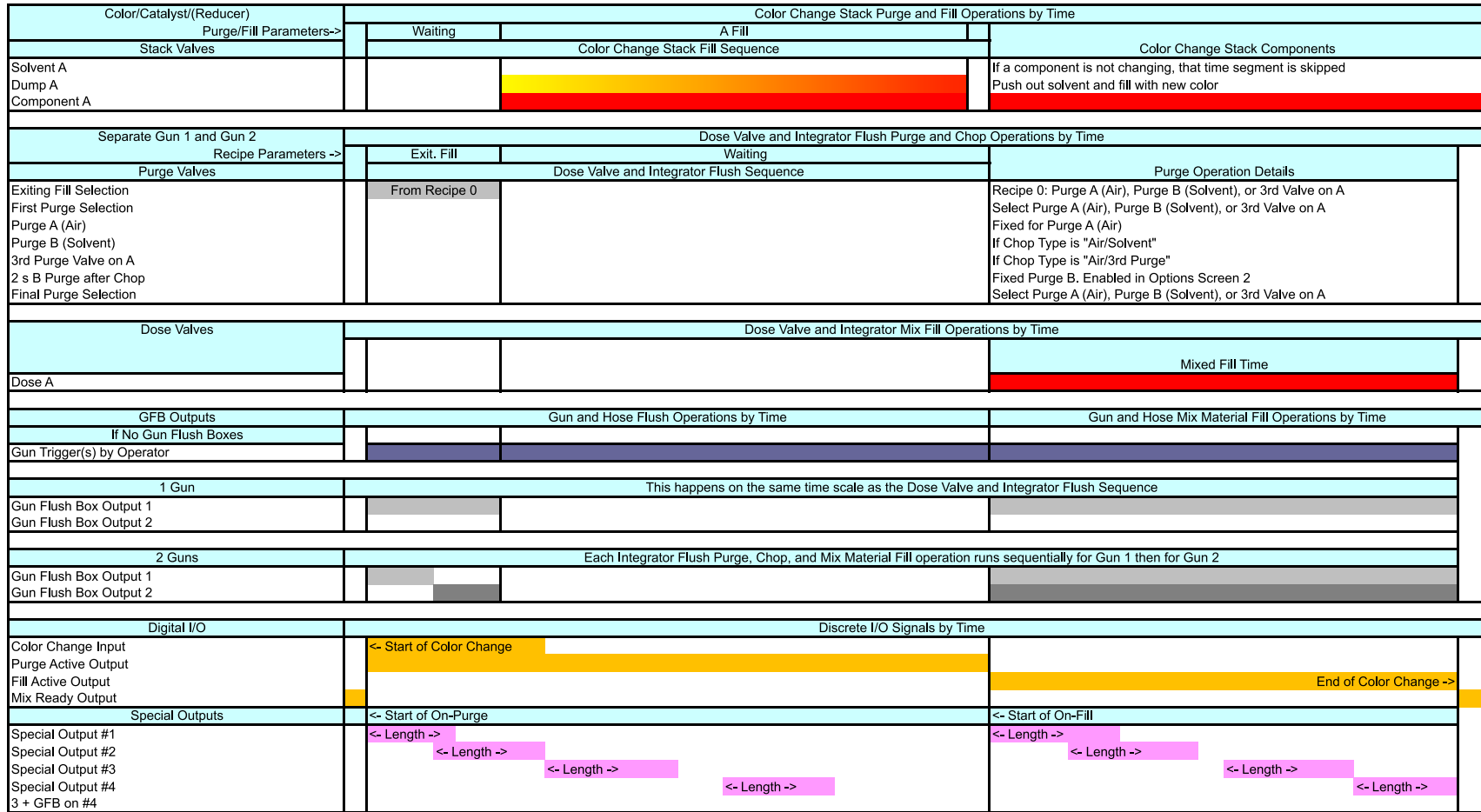

1KS 0 to Y K11 EN

FIG. 112: ProControl 1KS Recipe Fill Chart #3 0 to Y

ProControl 1KS Recipe Fill Chart #4 0 to Y
 Stack Valves A1
 Dump A Enabled, 3rd Flush Valve Enabled
 No Exiting Fill

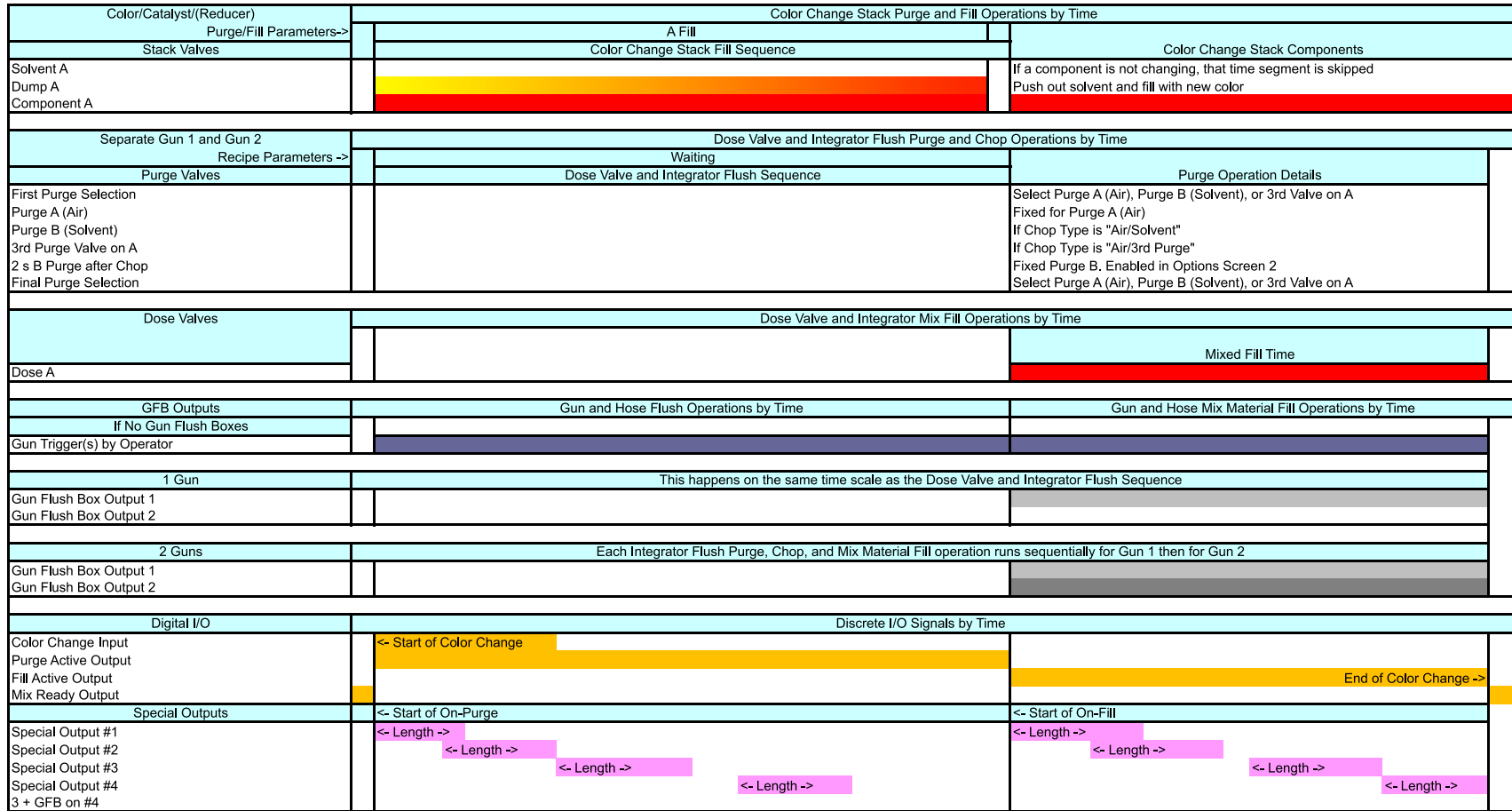

1KS 0 to Y K10 EN

FIG. 113: ProControl 1KS Recipe Fill Chart #4 0 to Y

ProControl 1KS Recipe Fill Chart #5 0 to Y
 Stack Valves A1
 No Dump A, 3rd Flush Valve Enabled
 Exiting Fill Enabled

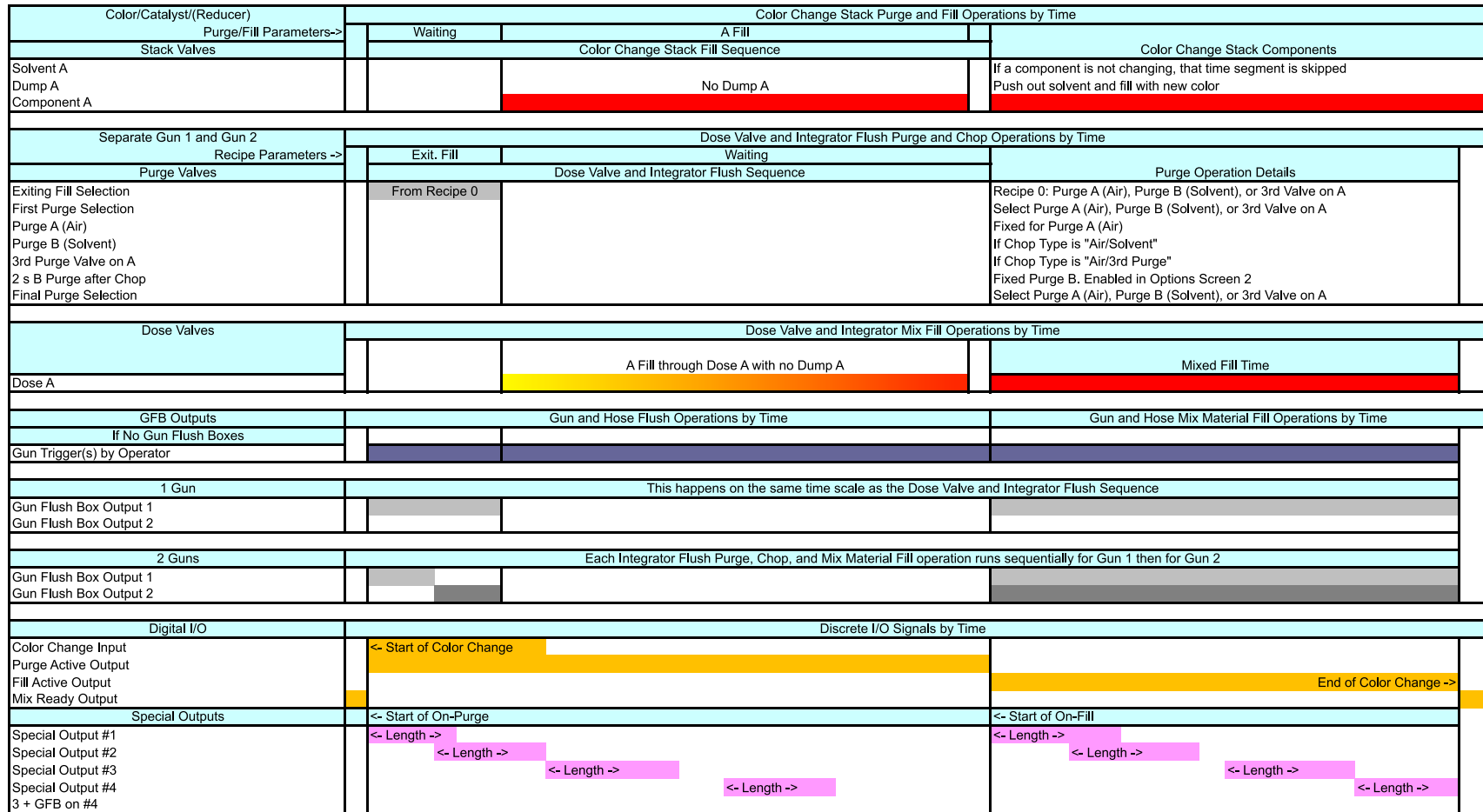

1KS 0 to Y K9 EN

FIG. 114: ProControl 1KS Recipe Fill Chart #5 0 to Y

ProControl 1KS Recipe Fill Chart #6 0 to Y
 Stack Valves A1
 No Dump A, 3rd Flush Valve Enabled
 No Exiting Fill

Color/Catalyst/(Reducer) Purge/Fill Parameters->	Color Change Stack Purge and Fill Operations by Time	
Stack Valves	A Fill	Color Change Stack Components
Solvent A	No Dump A	If a component is not changing, that time segment is skipped Push out solvent and fill with new color
Dump A		
Component A		
Separate Gun 1 and Gun 2 Recipe Parameters ->	Dose Valve and Integrator Flush Purge and Chop Operations by Time	
Purge Valves	Waiting	Purge Operation Details
First Purge Selection	Dose Valve and Integrator Flush Sequence	Select Purge A (Air), Purge B (Solvent), or 3rd Valve on A Fixed for Purge A (Air) If Chop Type is "Air/Solvent" If Chop Type is "Air/3rd Purge" Fixed Purge B. Enabled in Options Screen 2 Select Purge A (Air), Purge B (Solvent), or 3rd Valve on A
Purge A (Air)		
Purge B (Solvent)		
3rd Purge Valve on A		
2 s B Purge after Chop		
Final Purge Selection		
Dose Valves	Dose Valve and Integrator Mix Fill Operations by Time	
Dose A	A Fill through Dose A with no Dump A	Mixed Fill Time
GFB Outputs If No Gun Flush Boxes	Gun and Hose Flush Operations by Time	Gun and Hose Mix Material Fill Operations by Time
Gun Trigger(s) by Operator		
1 Gun	This happens on the same time scale as the Dose Valve and Integrator Flush Sequence	
Gun Flush Box Output 1		
Gun Flush Box Output 2		
2 Guns	Each Integrator Flush Purge, Chop, and Mix Material Fill operation runs sequentially for Gun 1 then for Gun 2	
Gun Flush Box Output 1		
Gun Flush Box Output 2		
Digital I/O	Discrete I/O Signals by Time	
Color Change Input	<- Start of Color Change	
Purge Active Output		
Fill Active Output		End of Color Change ->
Mix Ready Output		
Special Outputs	<- Start of On-Purge	<- Start of On-Fill
Special Output #1	<- Length ->	<- Length ->
Special Output #2	<- Length ->	<- Length ->
Special Output #3	<- Length ->	<- Length ->
Special Output #4	<- Length ->	<- Length ->
3 + GFB on #4		

1KS 0 to Y K8 EN

FIG. 115: ProControl 1KS Recipe Fill Chart #6 0 to Y

ProControl 1KS Recipe Purge Chart #7 X to 0
 Stack Valves Off
 Dump A Enabled, 3rd Flush Valve Enabled

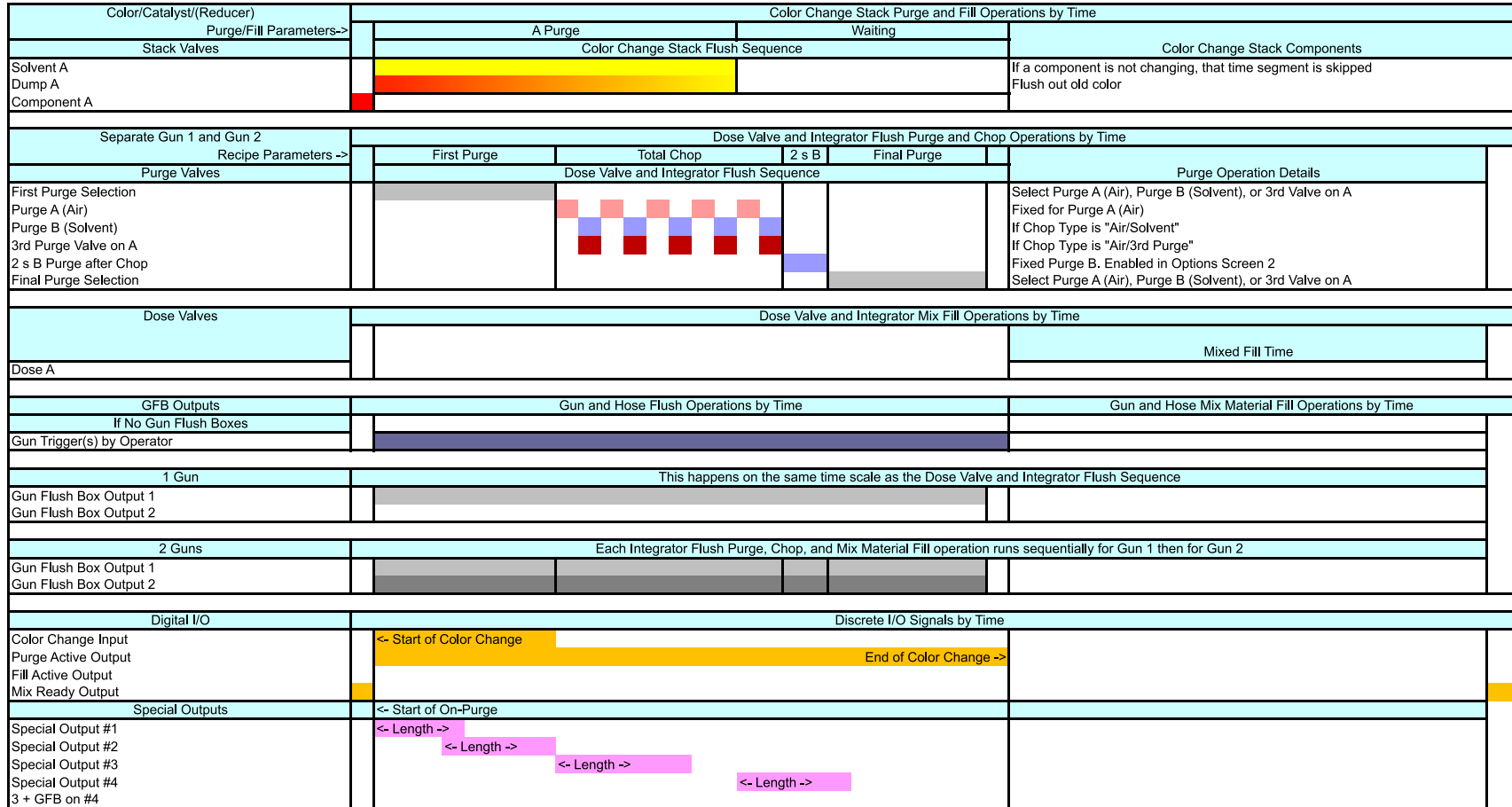

1KS X to 0 K11 EN

FIG. 116: ProControl 1KS Recipe Purge Chart #7 X to 0

ProControl 1KS Recipe Purge Chart #8 X to 0
 Stack Valves Off
 No Dump A, 3rd Flush Valve Enabled

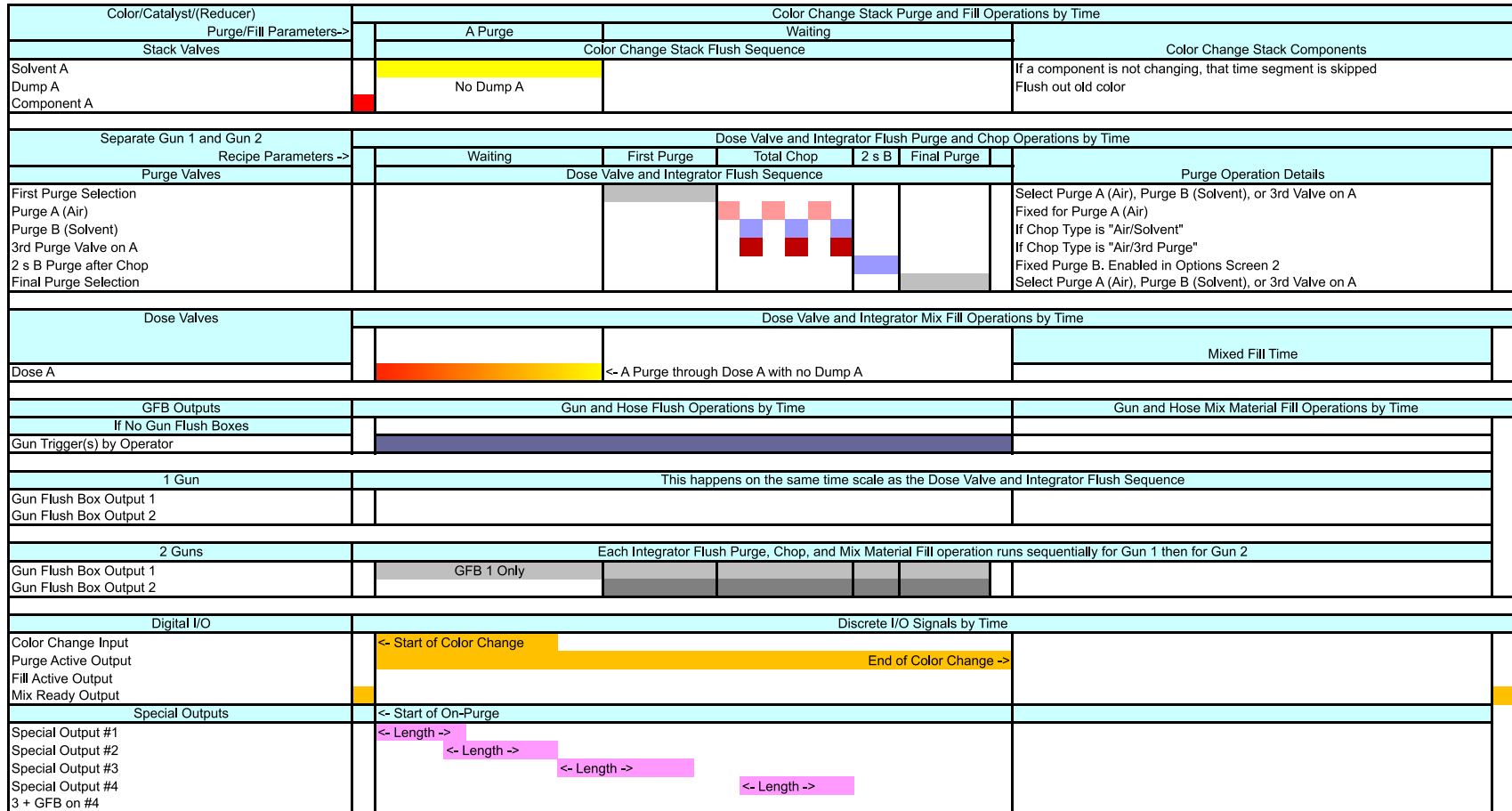

1KS X to 0 K9 EN

FIG. 117: ProControl 1KS Recipe Purge Chart #8 X to 0

ProControl 1KS Recipe Purge Chart #9 0 to 0
 Stack Valves Off
 Dump A Enabled, 3rd Flush Valve Enabled
 Exiting Fill Enabled

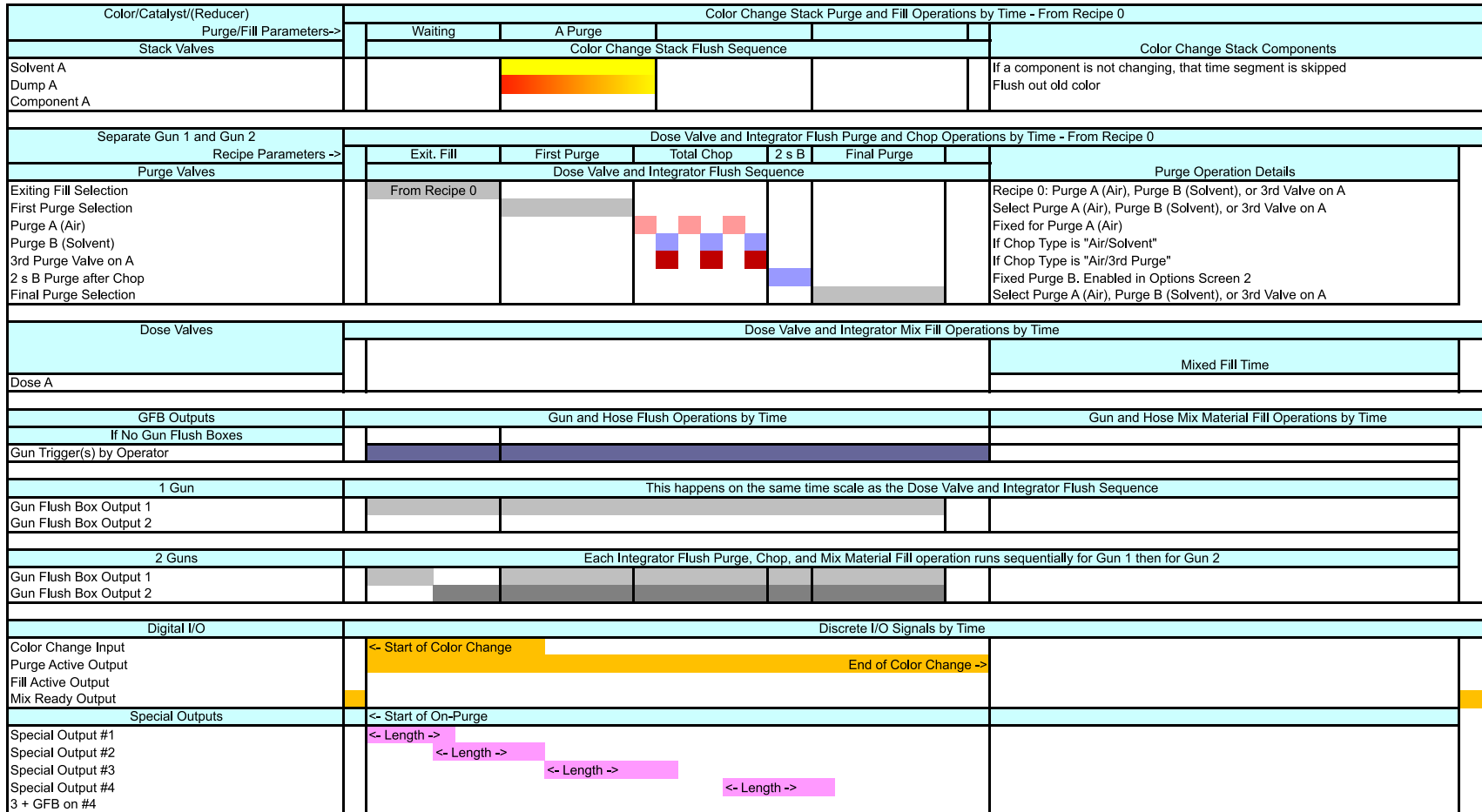

1KS 0 to 0 K3 EN

FIG. 118: ProControl 1KS Recipe Purge Chart #9 0 to 0

Alarms and Warnings

NOTE: Do not use the fluid in the line that was dispensed off ratio as it may not cure properly.

System Alarms

System alarms alert you of a problem and help prevent off-ratio spraying. If an alarm occurs, operation stops and the following occurs:

- Buzzer sounds (for E-2 only; see page 29 to set for all alarms).
- Status bar on the EasyKey shows the alarm E-Code with a description (see Table 17).

System Warnings

Table 17 lists the System Warning Codes. Warnings do not stop operation or sound an alarm. They are saved in the date/time stamped log, which can be viewed on a PC, using the ProControl 1KS Web Interface (see manual 313386).

To Reset Alarm and Restart

NOTE: When an alarm occurs be sure to determine the E-Code before resetting it. See Table 17. If you forget which E-Code occurred, use the **Alarms Screen** (page 24) to view the last 10 alarms, with date and time stamps.

To reset alarms, see Table 18. Many alarms can be

cleared by simply pressing the Alarm Reset  key.

Table 17: System Alarm/Warning Codes

Code	Description	Details
E-1	Communication Error Alarm	Page 119
E-2	Potlife Alarm	Page 119
E-3	Ratio High Alarm	Page 120
E-4	Ratio Low Alarm	Page 121
E-5	Overdose A/B Dose Too Short Alarm	Page 122
E-6	Overdose B/A Dose Too Short Alarm	Page 122
E-7	Dose Time A Alarm	Page 123
E-8	Dose Time B Alarm	Page 123
E-9	Not used	NA
E-10	Remote Stop Alarm	Page 124
E-11	Purge Volume Alarm	Page 124
E-12	CAN Network Communication Error Alarm	Page 125
E-13	High Flow Alarm	Page 126
E-14	Low Flow Alarm	Page 126
E-15	System Idle Warning	Page 126
E-16	Setup Change Warning	Page 126
E-17	Power On Warning	Page 126
E-18	Defaults Loaded Warning	Page 126
E-19	I/O Alarm	Page 127
E-20	Purge Initiate Alarm	Page 128
E-21	Material Fill Alarm	Page 128
E-22	Tank A Low Alarm	Page 128
E-23	Tank B Low Alarm	Page 128
E-24	Tank S Low Alarm	Page 128
E-25	Auto Dump Complete Alarm	Page 129
E-26	Color/Catalyst Purge Alarm	Page 129
E-27	Color/Catalyst Fill Alarm	Page 129
E-28	Mix Fill Push Complete	Page 129
E-29	Tank C Low Alarm	Page 129
E-30	Overdose C Alarm	Page 129
E-31	Dose Time C Alarm	Page 129

Alarm Troubleshooting

Table 18. Alarm Troubleshooting

E-1: COMM ERROR	
Cause	Solution
No power to the EasyKey.	Connect power to EasyKey.
No power to Fluid Station. The intrinsically safe power cable between the EasyKey and Fluid Station is not connected.	Verify that the cable is correctly connected. See Installation manual.
No power to Fluid Station. The fluid control board fuse is blown.	Verify condition of fuse and replace if necessary. See Repair-Parts manual.
The fiber optic cable between the EasyKey and Fluid Station is not connected.	Verify that the cable is correctly connected. See Installation manual.
The fiber optic cable is cut or bent.	Verify that the cable has not been cut or bent at a radius smaller than 1.6 in. (40 mm).
Dirty fiber optic cable ends.	Disconnect fiber optic cable ends and clean with a lint-free cloth.
A communication cable or connector failed.	Replace cable.
E-2: POTLIFE ALARM	
Cause	Solution
<p>The potlife time has been exceeded for the mixed material.</p> <div style="border: 1px solid black; background-color: #0000FF; color: white; padding: 2px; text-align: center; margin: 5px 0;">NOTICE</div> <p>To prevent mixed material from curing in the equipment, do not shut off power. Follow one of the solutions at right.</p>	<p>Press the Alarm Reset  key to stop the audible alarm. Purge the system with solvent, fresh mixed material, or a new color:</p> <ul style="list-style-type: none"> • Solvent Purge - See Purging Mixed Material on page 98. The system purges until the preset purge time is complete. • New Mixed Material Purge - Go to Mix mode and spray the required volume to restart the timer. • Color Change - Perform a color change, see page 104.

Table 18. Alarm Troubleshooting (Continued)

E-3: RATIO HIGH ALARM	
Sequential Dosing System	
The mix ratio is higher than the set tolerance on the previous dose cycle.	
Dynamic Dosing System	
The mix ratio is higher than the set tolerance for an A to B component volume comparison.	
Cause	Solution
There is too little restriction in the system.	<ul style="list-style-type: none"> • Check that the system is fully loaded with material. • Check that the supply pump's cycle rate is set properly. • Check that the spray tip/nozzle is properly sized for the flow and application, and that it is not worn. • Check that the fluid regulator is set properly.
If the alarm occurs during start up, after purging, the flow rate was probably too high.	Restrict gun needle travel to slow down the initial fluid delivery rate until fluid hoses are loaded with material.
If the alarm occurred after you were spraying for some time, the pressures from the fluid supplies could be unbalanced.	Adjust component A and B fluid supply regulator pressures until they are about equal. <i>If the pressures are already about equal</i> , verify that component A and B dose valves are operating properly.
Slow actuation of the component A or B valves. This can be caused by:	Manually operate the Dispense A and B solenoid valves as instructed in the Repair-Parts manual to check operation.
<ul style="list-style-type: none"> • Air pressure to the valve actuators is too low. 	<ul style="list-style-type: none"> • Increase air pressure. Air pressure must be 75-120 psi (0.52-0.84 MPa, 5.2-8.4 bar); 120 psi is recommended.
<ul style="list-style-type: none"> • Something is restricting the solenoid or tubing and interrupting valve actuation air. 	<ul style="list-style-type: none"> • There may be dirt or moisture in the air supply. Filter appropriately.
<ul style="list-style-type: none"> • A dose valve is turned in too far. 	<ul style="list-style-type: none"> • Refer to Table 14: Mix Manifold Valve Settings, page 92, for adjustment guidelines.
<ul style="list-style-type: none"> • Fluid pressure is high and air pressure is low. 	<ul style="list-style-type: none"> • Adjust air and fluid pressure. See recommended air pressure above.

Table 18. Alarm Troubleshooting (Continued)

E-4: RATIO LOW ALARM	
Sequential Dosing System	
The mix ratio is lower than the set tolerance on the previous dose cycle.	
Dynamic Dosing System	
The mix ratio is lower than the set tolerance for an A to B component volume comparison.	
Cause	Solution
There is too much restriction in the system.	<ul style="list-style-type: none"> • Check that the system is fully loaded with material. • Check that the supply pump's cycle rate is set properly. • Check that the spray tip/nozzle is properly sized for the flow and application, and that it is not clogged. • Check that the fluid regulator is set properly.
If the alarm occurs during start up, after purging, the flow rate was probably too high.	Restrict gun needle travel to slow down the initial fluid delivery rate until fluid hoses are loaded with material.
If the alarm occurred after you were spraying for some time, the pressures from the fluid supplies could be unbalanced.	Adjust component A and B fluid supply regulator pressures until they are about equal. <i>If the pressures are already about equal</i> , verify that component A and B dose valves are operating properly.
Slow actuation of the component A or B valves. This can be caused by:	Manually operate the Dispense A and B solenoid valves as instructed in the Repair-Parts manual to check operation.
<ul style="list-style-type: none"> • Air pressure to the valve actuators is too low. 	<ul style="list-style-type: none"> • Increase air pressure. Air pressure must be 75-120 psi (0.52-0.84 MPa, 5.2-8.4 bar); 120 psi is recommended.
<ul style="list-style-type: none"> • Something is restricting the solenoid or tubing and interrupting valve actuation air. 	<ul style="list-style-type: none"> • There may be dirt or moisture in the air supply. Filter appropriately.
<ul style="list-style-type: none"> • A dose valve is turned in too far. 	<ul style="list-style-type: none"> • Refer to Table 14: Mix Manifold Valve Settings, page 92, for adjustment guidelines.
<ul style="list-style-type: none"> • Fluid pressure is high and air pressure is low. 	<ul style="list-style-type: none"> • Adjust air and fluid pressure. See recommended air pressure above.

Table 18. Alarm Troubleshooting (Continued)

E-5: OVERDOSE A/B DOSE TOO SHORT ALARM and E-6: OVERDOSE B/A DOSE TOO SHORT ALARM	
E-5: the A dose overshoots and, when combined with B, is too large for the mix chamber capacity.	
E-6: the B dose overshoots and forces an A side dose that, when combined with B, is too large for the mix chamber capacity.	
Cause	Solution
Valve seal or needle/seat are leaking. Check FIG. 16 Totals Screen on page 23. If A and B are dosing simultaneously (sequential dosing only), there is a leak.	Repair the valve (see valve manual 312782).
Sampling valve is leaking.	Tighten or replace valve.
Flow meter fluctuations caused by pressure pulsations.	<p>Check for pressure pulsations:</p> <ol style="list-style-type: none"> 1. Close all the manifold valves. 2. Turn on the circulating pumps and all the booth equipment (such as fans and conveyors). 3. Check if the ProControl 1KS is reading any fluid flow. 4. If the ProControl 1KS shows there is fluid flow and there are no leaks from the gun or any other seals or fittings, the flow meters are probably being affected by pressure pulsations. 5. Close the fluid shutoff valve between the fluid supply system and the flow meter. The flow indication should stop. 6. If necessary, install pressure regulators or a surge tank on the fluid inlets to the ProControl 1KS to reduce the fluid supply pressure. Contact your Graco distributor for information.
Slow actuation of component A or B valves.	See E-3: RATIO HIGH ALARM and E-4: RATIO LOW ALARM , pages 120-121.
Running a high mix ratio and a high flow rate.	It may be necessary to restrict the flow rate through the component B dose valve by adjusting its hex nut (E). See page 91.

Table 18. Alarm Troubleshooting (Continued)

E-7: DOSE TIME A ALARM and E-8: DOSE TIME B ALARM	
E-7: gun trigger input is active (AFS or Integration) and fewer than 31 A meter pulses were detected during the dose time selected.	
E-8: gun trigger input is active (AFS or Integration) and fewer than 31 B meter pulses were detected during the dose time selected.	
Cause	Solution
System is in Mix mode and gun is only partially triggered, allowing air but no fluid to pass through gun.	Fully trigger the gun.
Fluid flow rate is too low.	Increase flow rate.
Dose time setting is too short for the current flow rate.	Increase the dose time setting.
Flow meter or cable failed or flow meter clogged.	<p>To check meter sensor operation, remove meter cap to expose sensor. Pass a ferrous metal tool in front of the sensor.</p>  <p style="text-align: right;">T112792a</p> <p>If there is a meter or cable failure, you will see a large difference between the amount of fluid dispensed and the flow meter volume displayed by the EasyKey. Clean or repair meter as necessary. Also see meter manual 308778.</p> <p>Follow Meter Calibration procedure, page 102.</p>
Slow actuation of component A or B valves.	See E-3: RATIO HIGH ALARM and E-4: RATIO LOW ALARM , pages 120-121.
The supply pump is not turned on.	Turn on the supply pump.
System is in Mix mode with 0 volume entered for Min Material Fill Volume (see Option Screen 1 , page 32), and Fuse F1 is blown.	Verify condition of fuse and replace if necessary. See Repair-Parts manual.

Table 18. Alarm Troubleshooting (Continued)

E-9: Not used	
E-10: REMOTE STOP ALARM	
Cause	Solution
Automation has requested that the system abort all operations.	Abort operations. Troubleshoot automation system.
E-11: PURGE VOLUME ALARM	
Cause	Solution
ProControl 1KS solvent flow switch is not activated while purging.	Verify that the gun is not shut off and that the solvent flow switch is activated while purge is taking place.
Minimum flush volume is not achieved.	Increase solvent supply or decrease minimum volume setting.
No meter pulses during Color/Catalyst Dump.	Color change solvent supply not set up or functional. Check Color Change setup.

Table 18. Alarm Troubleshooting (Continued)

E-12: CAN COMM ERROR ALARM	
Cause	Solution
Communication between the Color Change Module and the Fluid Station is interrupted.	<ul style="list-style-type: none"> Verify that all cables are connected securely and that the Color Change power LED turns on. If the power LED does not turn on, the problem is probably caused by a bad connection. The nut on the connector must make at least 5 complete turns to ensure a good connection. If the power LED still does not light, the cable or board is bad.
	<ul style="list-style-type: none"> Check the color change board DIP switch settings. See the Installation manual.
	<ul style="list-style-type: none"> Check the fluid plate board DIP switch setting. An incorrect setting will not cause E-12 alarms, but a correct setting will help prevent E-12 caused by electrical noise. See the Installation manual.
	<ul style="list-style-type: none"> Check EasyKey software version (displayed at power up for all versions and when the lock key is pressed for version 2.02.000 and above). If older than 1.06.002, upgrade. Be sure to save settings through BWI or AWI before upgrading, as they will be erased.
	<ul style="list-style-type: none"> The sticker on the color change board shows the software part number and version, for example 15T270 1.01. If the version is older than 1.01, replace the board.
	<ul style="list-style-type: none"> If all software versions and DIP switch settings are correct and you still have E-12 alarms, then the system has a bad connection, bad cable, or bad circuit board. Use a multimeter on the CAN connectors to test whether there is a good connection between systems. If there is, you have a bad circuit board. If there is not, you have a bad connector, connection, or cable.
	<ul style="list-style-type: none"> Appears on the EasyKey display if the unit is programmed for Manual Mode, and a booth control is not connected.
	<ul style="list-style-type: none"> The dip switch settings on the Color Change Control Module were changed (see manual 312787) while the power was on. Cycle the power to clear the alarm.
Communication between the Color Change Module and the Fluid Station is interrupted. The fluid control board fuse is blown.	<ul style="list-style-type: none"> The dip switch configuration on the Color Change Control Module (see manual 312787) is setup incorrectly.
	Verify condition of fuse and replace if necessary. See Repair-Parts manual.

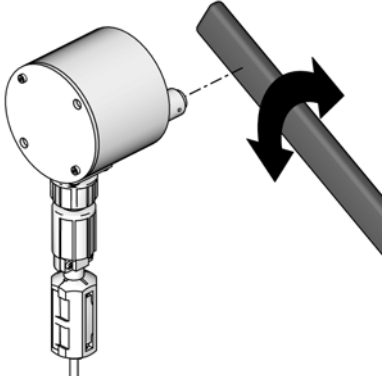
Table 18. Alarm Troubleshooting (Continued)

E-13: HIGH FLOW ALARM or E-14: LOW FLOW ALARM (may also be set as Warnings)	
Cause	Solution
Fluid system is producing too much or too little flow.	Troubleshoot fluid system for restrictions, leaks, exhausted fluid supply, incorrect settings, etc. Increase or decrease flow rate, as required.
E-15: SYSTEM IDLE WARNING	
Cause	Solution
Mix input is high, but the gun has not been triggered for 2 minutes.	If not painting, clear alarm and resume operation. If painting, shut down and inspect fluid meter.
E-16: SETUP CHANGE WARNING	
Cause	Solution
The system setup parameters have been changed.	No action required. See Event Log available through advanced web interface.
E-17: POWER ON WARNING	
Cause	Solution
The power to the system has been cycled.	No action required. See Event Log available through advanced web interface.
Voltage becoming too low due to weak power supply.	Replace power supply. See Repair-Parts manual.
Power wires are disconnected or making intermittent contact.	Check that all wires are securely connected. Ensure that wires are not stretched too tightly.
Reset button has been pushed (S1 on EasyKey display board, S3 on Autokey).	No action required. See Event Log available through advanced web interface.
Software update is initiated on EasyKey.	No action required. See Event Log available through advanced web interface.
E-18: DEFAULTS LOADED WARNING	
Cause	Solution
The factory defaults have been installed on the system.	No action required. See Event Log available through advanced web interface.

Table 18. Alarm Troubleshooting (Continued)

E-19: I/O ALARM	
Cause	Solution
The Mix and Purge digital inputs are on at the same time.	Ensure that only one input is on at a time. At least 1 sec delay is required when switching from Mix to Purge or vice versa.
NOTE: The I/O alarm incorporates several sub-alarms relating to internal data issues, as detailed below. These alarms are only seen in the Alarm log or through BWI or AWI, and may not apply to all software versions.	
FP Reboot (Fluid Plate Reboot): Occurs if the system detects a fluid plate control board reboot or power cycle not triggered from the EasyKey. The system reverts to Recipe 61, and mixed material may be in the lines.	Flush the system or perform a color change. If possible, identify the origin of the reboot or power cycle.
Autokey Lost: Occurs if the Autokey is lost or changed after having been detected. (A short term loss of the Autokey will not be registered.) Some system functions may become unavailable. For example, an automatic system will not respond to PLC or robot control.	Reinstall the Autokey, or verify that the Autokey is set properly.
Illegal Source: Occurs if a recipe outside of the range 1-60 is detected as the source data for global recipe data copies. This is possible if an invalid configuration file is sent to the EasyKey.	Verify that the source data is from a valid recipe (1-60).
2K/3K Error: Occurs if the recipe data is incompatible with the current Autokey setting (2K or 3K). This is possible if the Autokey is changed or an invalid configuration file is sent to the EasyKey.	Verify that the Autokey is set properly or that the configuration file is valid.
Init Error: Occurs if the recipe data codes specifying the type of machine they were made on are not what is expected. For example, a 3KS machine receives a configuration file originally made on a 2KS machine.	Verify that the configuration file is valid.
Config Error: Occurs if a configuration file sent to the EasyKey specifies a different hardware setup than what exists. For example, the configuration file specifies 2 color change boards but only 1 is present.	Verify that the configuration file specifications and the hardware conform.
Range Error: Occurs if a valve used in a recipe is not present in the current hardware setup. For example, a recipe calls for valve 30 but the system has only 12 valves.	Verify that the recipe specifications and the hardware conform.
LC Error (Level Control Error): Occurs if level control data is received by the EasyKey, and the current Autokey setting (2K or 3K) has changed since the level control data was originally initialized.	Verify that the Autokey is set properly.
LC Range Error (Level Control Range Error): Occurs if level control data includes a valve range exceeding the capability of the machine.	Set level control data correctly.
MB Overflow (Modbus Overflow): Occurs if the Modbus connection to a PLC experiences data overflow.	Verify the Modbus protocol to the EasyKey.

Table 18. Alarm Troubleshooting (Continued)

E-20: PURGE INITIATE ALARM	
Cause	Solution
System detects atomizing air to the gun when purge is selected.	Shut off gun air.
For systems with a gun flush box, gun is not in the box when purge is selected.	Place gun in gun flush box. Verify that gun flush box is operating properly.
For systems with auto dump on, gun is not in the box when auto dump is initiated.	Place gun in gun flush box. Verify that gun flush box is operating properly.
For systems with a gun flush box, Fuse F2 is blown.	Verify condition of fuse and replace if necessary. See Repair-Parts manual.
E-21: MATERIAL FILL ALARM	
Cause	Solution
For systems with minimum mixed material fill volume entered, the system detects that fill volume is not achieved during mixed material fill time.	<p>Check for restrictions or leaks in the fluid supply system.</p> <p>Check if the fill volume is properly configured:</p> <ul style="list-style-type: none"> • Adjust fill volume. • Adjust fill time.
For systems without color change and with minimum mixed material fill volume entered, Fuse F1 is blown.	Verify condition of fuse and replace if necessary. See Repair-Parts manual.
E-22: TANK A LOW ALARM, E-23: TANK B LOW ALARM, or E-24: TANK S LOW ALARM	
Cause	Solution
The tank volume reaches the low-level threshold.	<p>The EasyKey screen will display the alarm and prompt the user to do one of the following:</p> <ul style="list-style-type: none"> • Refill tank volume to clear the alarm. • Resume mixing by selecting “Spray 25% of remaining volume.” If this selection is chosen, a second alarm will occur after 25% of the remaining volume is mixed. Refill tank volume to clear the alarm.

Table 18. Alarm Troubleshooting (Continued)

E-25: AUTO DUMP COMPLETE ALARM	
Cause	Solution
A potlife alarm is active for more than 2 minutes, the gun flush box is enabled and gun is in the gun flush box, and an auto dump flush sequence is complete.	Be sure to spray all mixed material before potlife expires.
E-26: COLOR/CATALYST PURGE ALARM	
Cause	Solution
System detects no meter pulses, or a disruption in meter pulses lasting longer than 1 second throughout the Color/Catalyst purge time duration.	Check that meter cable is connected. Clean or repair meter.
E-27: COLOR/CATALYST FILL ALARM	
Cause	Solution
System detects no meter pulses, or system must detect at least 10cc of material from each side throughout the Color/Catalyst fill time duration.	Check that meter cable is connected. Clean or repair meter.
Gun, dump valve, or correct color/catalyst valve not open.	Open the valve.
Exhausted fluid supply.	Check fluid level and refill if necessary.
Switch settings (S3-S6) on color change board do not match hardware configuration.	Verify that color change board switches are set correctly. See installation manual.
Fuse F1, F2, or both are blown.	Verify condition of fuses and replace if necessary. See Repair-Parts manual.
E-28: MIX FILL PUSH COMPLETE	
Cause	Solution
Potlife of mixed material expired and new material has replaced the expired material.	Expired material purged.
E-29: TANK C LOW ALARM	
Cause	Solution
NA for this system type.	
E-30: OVERDOSE C ALARM	
Cause	Solution
NA for this system type.	
E-31: DOSE TIME C ALARM	
Cause	Solution
NA for this system type.	

Schematic Diagrams

System Pneumatic Schematic

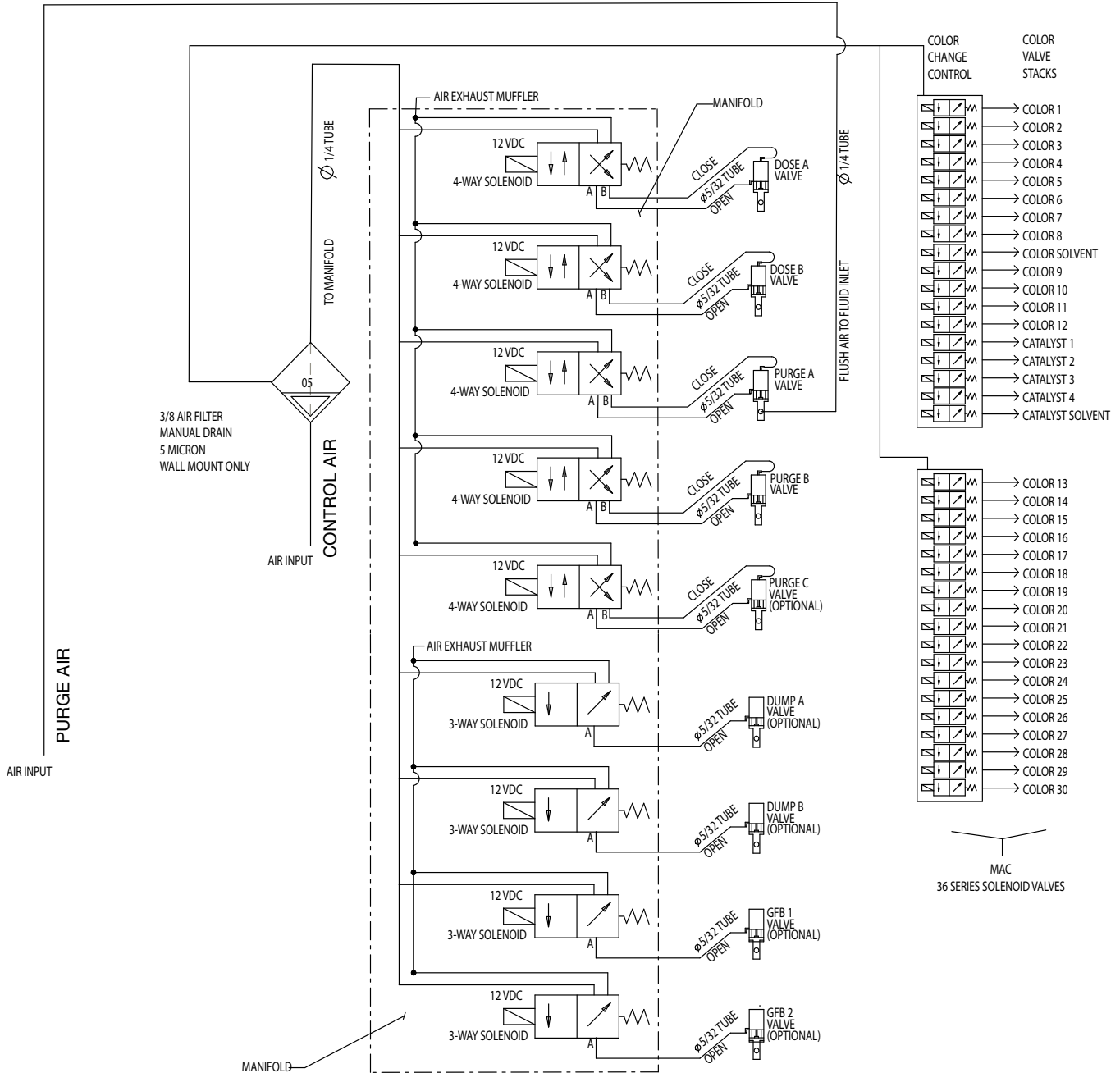

System Electrical Schematic

NOTE: The electrical schematic illustrates all possible wiring expansions in a ProControl 1KS system. Some components shown are not included with all systems.

Non-Hazardous Area

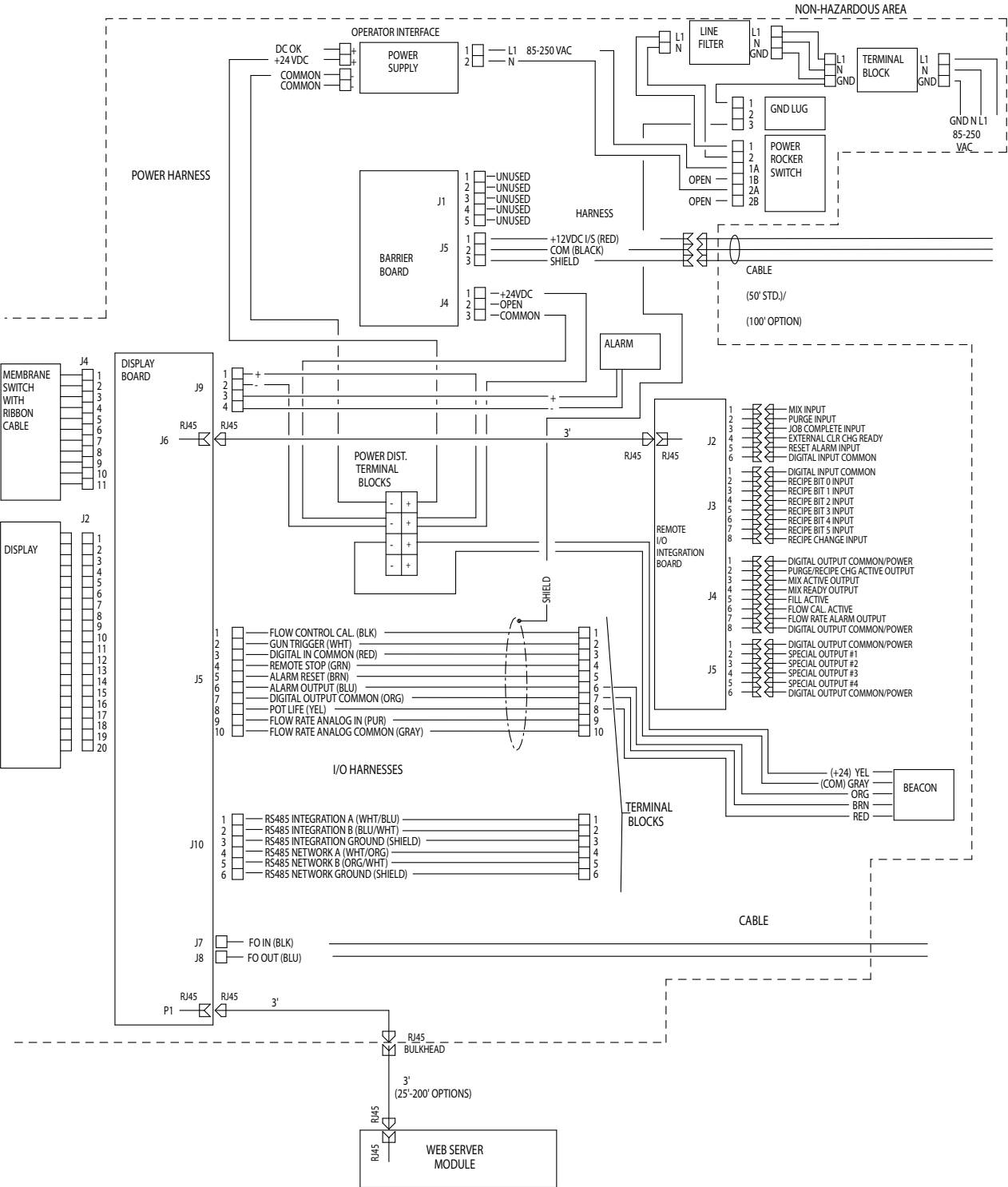

System Electrical Schematic

NOTE: The electrical schematic illustrates all possible wiring expansions in a ProControl 1KS system. Some components shown are not included with all systems.

Hazardous Area

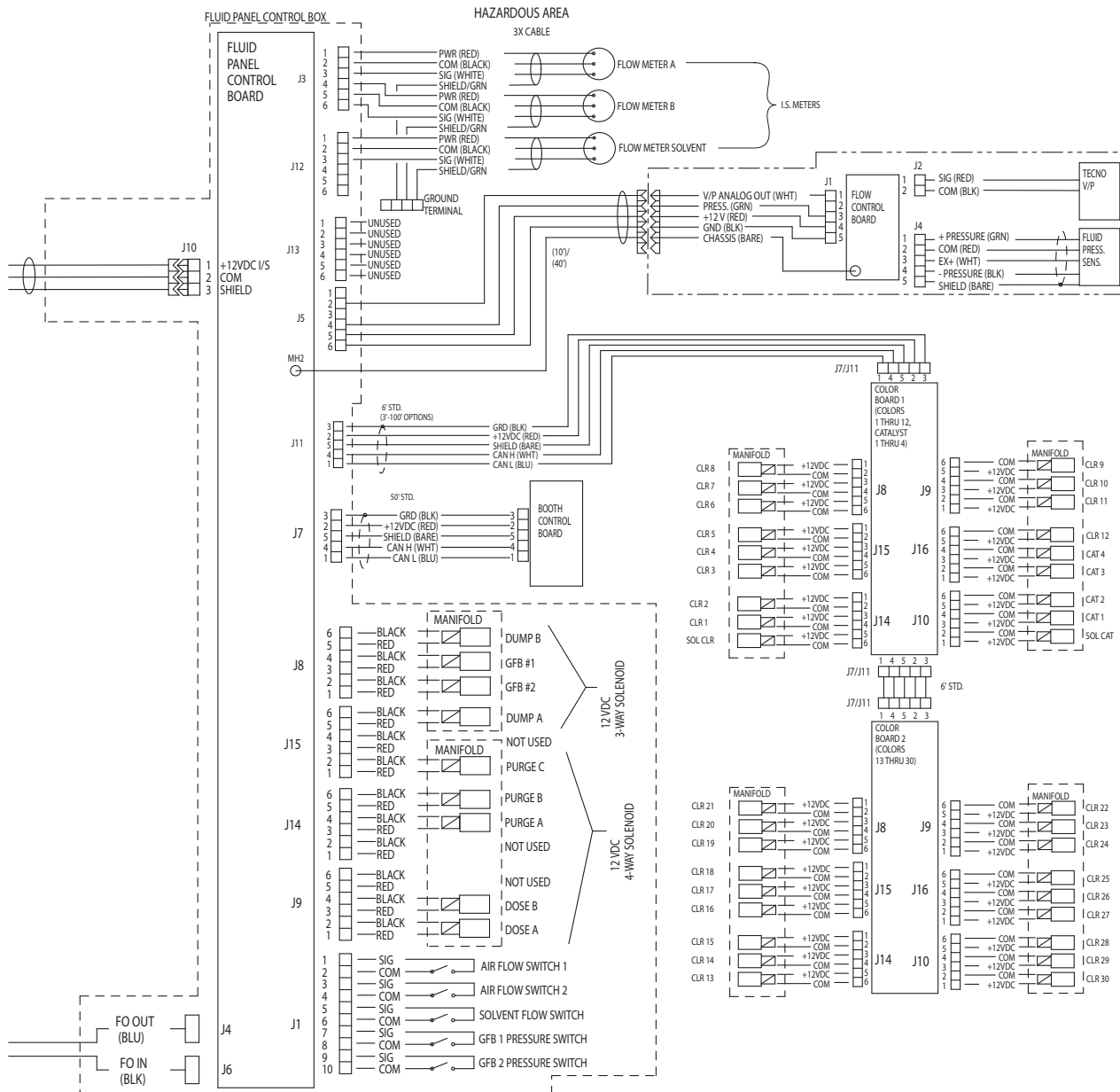

EasyKey Electrical Schematic

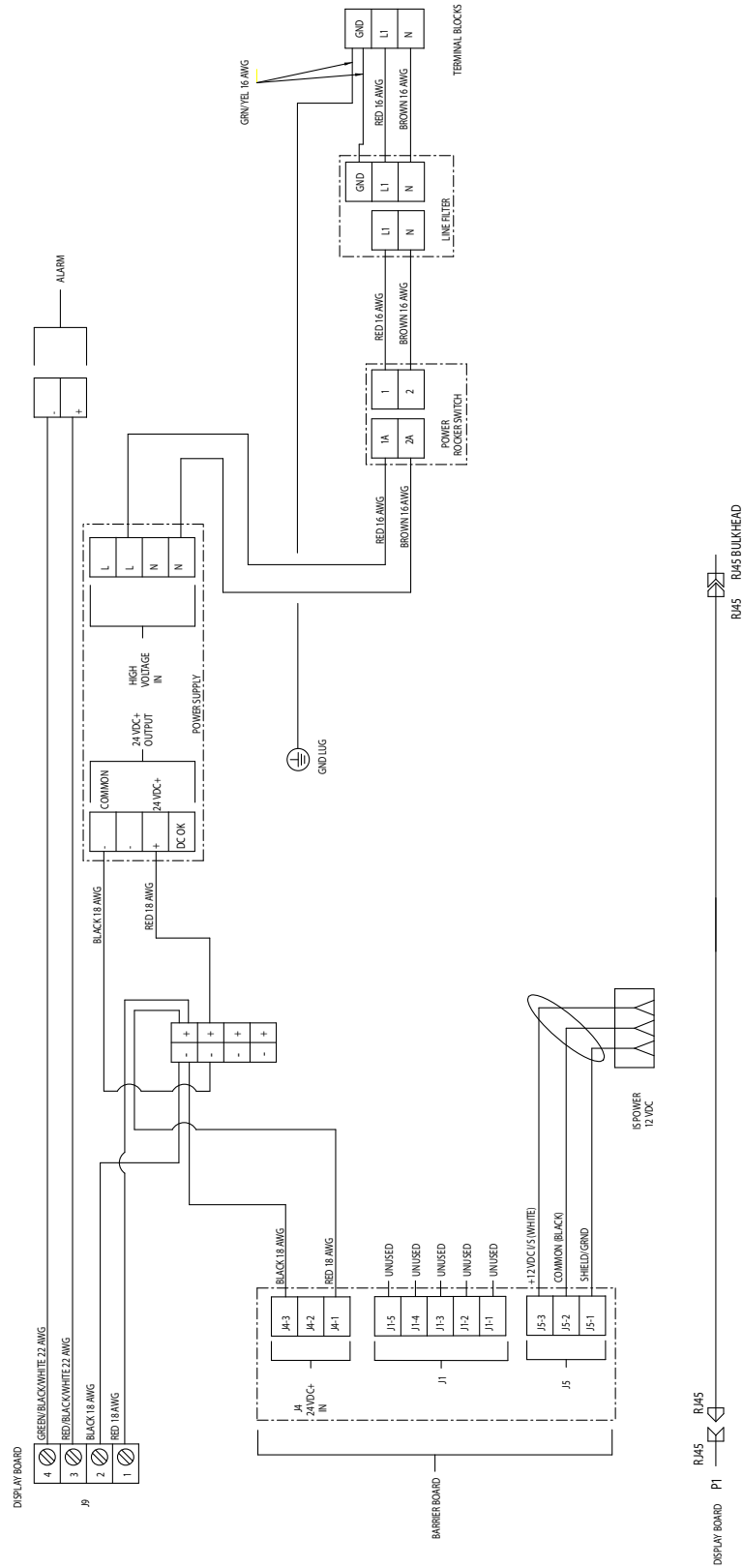

Meter Performance Data (G3000 on A and B)

NOTE: Maximum system flow is 3800 cc/min.

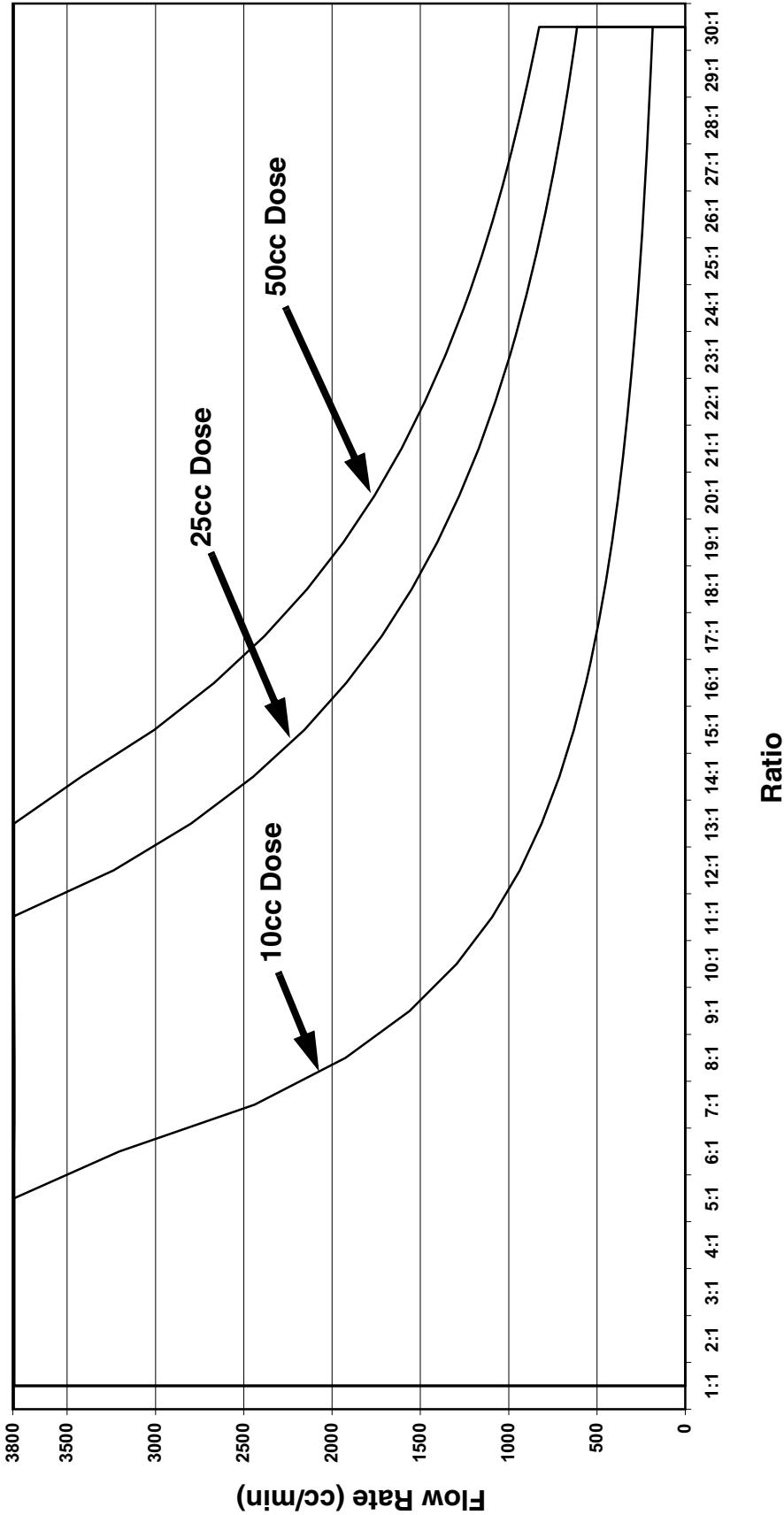

Test Conditions
Fluid: Hydraulic Oil
Viscosity: 65.7 centipoise
Ratio Tolerance: 5%
Valve Setting: 1.25 Turns Open (standard setting)
A and B Feed Pressure: 300 psig

Meter Performance Data (G3000 on A, Coriolis on B)

NOTE: Maximum system flow is 3800 cc/min.

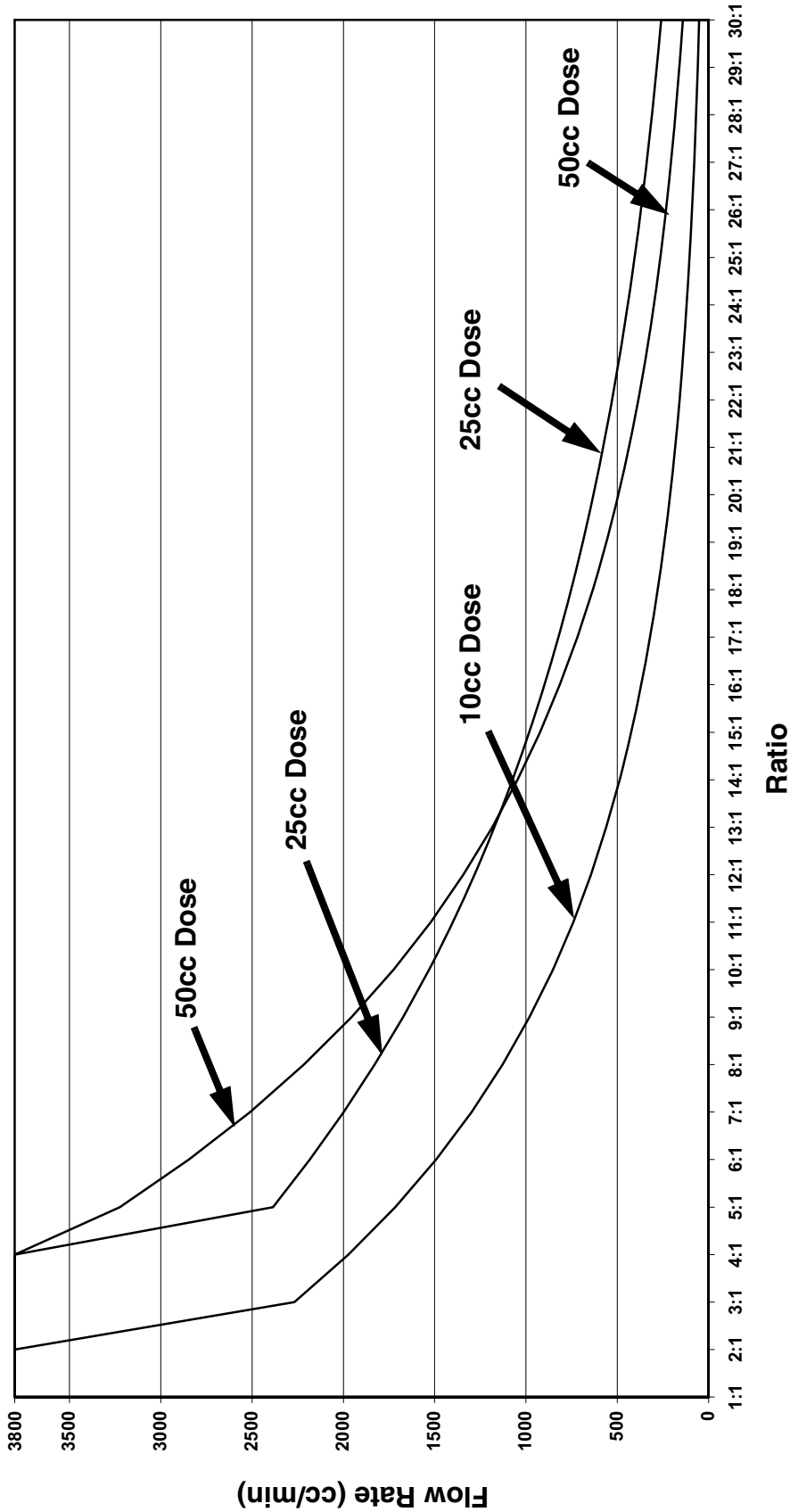

Test Conditions
Fluid: Hydraulic Oil
Viscosity: 65.7 centipoise
Ratio Tolerance: 5%
Valve Setting: 1.25 Turns Open (standard setting)
A and B Feed Pressure: 300 psig

Technical Data

Maximum fluid working pressure	<i>Base system:</i> 4000 psi (27.58 MPa, 275.8 bar) <i>Low pressure color change:</i> 300 psi (2.07 MPa, 20.6 bar) <i>Coriolis meter:</i> 2300 psi (15.86 MPa, 158.6 bar) <i>RoboMix system:</i> 190 psi (1.31 MPa, 13.1 bar) <i>Flow control:</i> 190 psi (1.31 MPa, 13.1 bar)
Maximum working air pressure	100 psi (0.7 MPa, 7 bar)
Air supply	75 - 100 psi (0.5 - 0.7 MPa, 5.2 - 7 bar)
Air filter inlet size	3/8 npt(f)
Air filtration for air logic and purge air (Graco-supplied).	5 micron (minimum) filtration required; clean and dry air
Air filtration for atomizing air (user-supplied)	30 micron (minimum) filtration required; clean and dry air
Mixing ratio range	0.1:1- 50:1*
On-ratio accuracy	up to \pm 1%, user selectable
Fluids handled	one or two component: <ul style="list-style-type: none"> • solvent and waterborne paints • polyurethanes • epoxies • acid catalyzed varnishes • moisture sensitive isocyanates
Viscosity range of fluid	20- 5000 cps*
Fluid filtration (user-supplied)	100 mesh minimum
Fluid flow rate range*	
G3000, G250 Meter	75 - 3800 cc/min. (0.02-1.00 gal./min.)
G3000HR, G250HR Meter	38 - 1900 cc/min. (0.01-0.50 gal./min.)
Coriolis Meter	20 - 3800 cc/min. (0.005-1.00 gal./min.)
S3000 Solvent Meter (accessory)	38 - 1900 cc/min. (0.01-0.50 gal./min.)
Fluid inlet sizes	
Flow Meter	1/4 npt(f)
Dose Valve/Color Valve Adapters	1/4 npt(f)
Fluid outlet size (static mixer)	1/4 npt(f)
External Power Supply Requirements	85 - 250 Vac, 50/60 Hz, 2 amps maximum draw 15 amp maximum circuit breaker required 8 to 14 AWG power supply wire gauge
Operating temperature range	41- 122° F (5-50° C)
Environmental Conditions Rating	indoor use, pollution degree (2), installation category II
Noise Level	
Sound pressure level	below 70 dBA
Sound power level	below 85 dBA
Wetted parts	303, 304 SST, Tungsten carbide (with nickel binder), perfluoroelastomer; PTFE

* Dependent on programmed K-factor and application. The maximum allowable flow meter pulse frequency is 425 Hz (pulses/sec). For more detailed information on viscosities, flow rates, or mixing ratios, consult your Graco distributor.

See individual component manuals for additional technical data.

Graco Standard Warranty

Graco warrants all equipment referenced in this document which is manufactured by Graco and bearing its name to be free from defects in material and workmanship on the date of sale to the original purchaser for use. With the exception of any special, extended, or limited warranty published by Graco, Graco will, for a period of twelve months from the date of sale, repair or replace any part of the equipment determined by Graco to be defective. This warranty applies only when the equipment is installed, operated and maintained in accordance with Graco's written recommendations.

This warranty does not cover, and Graco shall not be liable for general wear and tear, or any malfunction, damage or wear caused by faulty installation, misapplication, abrasion, corrosion, inadequate or improper maintenance, negligence, accident, tampering, or substitution of non-Graco component parts. Nor shall Graco be liable for malfunction, damage or wear caused by the incompatibility of Graco equipment with structures, accessories, equipment or materials not supplied by Graco, or the improper design, manufacture, installation, operation or maintenance of structures, accessories, equipment or materials not supplied by Graco.

This warranty is conditioned upon the prepaid return of the equipment claimed to be defective to an authorized Graco distributor for verification of the claimed defect. If the claimed defect is verified, Graco will repair or replace free of charge any defective parts. The equipment will be returned to the original purchaser transportation prepaid. If inspection of the equipment does not disclose any defect in material or workmanship, repairs will be made at a reasonable charge, which charges may include the costs of parts, labor, and transportation.

THIS WARRANTY IS EXCLUSIVE, AND IS IN LIEU OF ANY OTHER WARRANTIES, EXPRESS OR IMPLIED, INCLUDING BUT NOT LIMITED TO WARRANTY OF MERCHANTABILITY OR WARRANTY OF FITNESS FOR A PARTICULAR PURPOSE.

Graco's sole obligation and buyer's sole remedy for any breach of warranty shall be as set forth above. The buyer agrees that no other remedy (including, but not limited to, incidental or consequential damages for lost profits, lost sales, injury to person or property, or any other incidental or consequential loss) shall be available. Any action for breach of warranty must be brought within two (2) years of the date of sale.

GRACO MAKES NO WARRANTY, AND DISCLAIMS ALL IMPLIED WARRANTIES OF MERCHANTABILITY AND FITNESS FOR A PARTICULAR PURPOSE, IN CONNECTION WITH ACCESSORIES, EQUIPMENT, MATERIALS OR COMPONENTS SOLD BUT NOT MANUFACTURED BY GRACO. These items sold, but not manufactured by Graco (such as electric motors, switches, hose, etc.), are subject to the warranty, if any, of their manufacturer. Graco will provide purchaser with reasonable assistance in making any claim for breach of these warranties.

In no event will Graco be liable for indirect, incidental, special or consequential damages resulting from Graco supplying equipment hereunder, or the furnishing, performance, or use of any products or other goods sold hereto, whether due to a breach of contract, breach of warranty, the negligence of Graco, or otherwise.

FOR GRACO CANADA CUSTOMERS

The Parties acknowledge that they have required that the present document, as well as all documents, notices and legal proceedings entered into, given or instituted pursuant hereto or relating directly or indirectly hereto, be drawn up in English. Les parties reconnaissent avoir convenu que la rédaction du présente document sera en Anglais, ainsi que tous documents, avis et procédures judiciaires exécutés, donnés ou intentés, à la suite de ou en rapport, directement ou indirectement, avec les procédures concernées.

Graco Information

For the latest information about Graco products, visit www.graco.com.

For patent information, see www.graco.com/patents.

TO PLACE AN ORDER, contact your Graco distributor or call to identify the nearest distributor.

Phone: 612-623-6921 **or Toll Free:** 1-800-328-0211 **Fax:** 612-378-3505

*All written and visual data contained in this document reflects the latest product information available at the time of publication.
Graco reserves the right to make changes at any time without notice.*

Original instructions. This manual contains English. MM 3A1080

Graco Headquarters: Minneapolis

International Offices: Belgium, China, Japan, Korea

GRACO INC. AND SUBSIDIARIES • P.O. BOX 1441 • MINNEAPOLIS MN 55440-1441 • USA
Copyright 2009, Graco Inc. All Graco manufacturing locations are registered to ISO 9001.

www.graco.com
Revision H, 2019-03